



FOX[®]

be smart

UPUTSTVO
ZA UPOTREBU

LED TELEVIZORI
MODEL:
55WOS626D

SRB

Hvala što ste kupili ovaj uređaj.

FOX LED televizori su poznati po odličnim tehničkim karakteristikama, kao i po modernom, funkcionalnom i elegantnom dizajnu. Pored toga imamo efikasnu i široku mrežu servisa, koja našim ponosnim korisnicima uliva sigurnost.

Napravili ste pravi izbor.

U nastavku slede uputstva za upotrebu.
Nisu komplikovana ali ih morate pažljivo pročitati i dosledno ih se pridržavati.

Informacije o proizvodu (lista sa podacima)

Informacije	Vrednost	Jedinica
1. Ime ili zaštitni znak isporučioaca	VIMPORT DOO BEOGRAD	
Adresa isporučioaca	Batajnički drum 9 deo 10a, Beograd(Zemun)	
2. Identifikaciona oznaka modela	FOX LED TV 55WOS626D	
3. Klasa energetske efikasnosti za SDR mod	F	
4. Snaga u uključenom stanju za standardni dinamički raspon (SDR)	76.0	W
5. Klasa energetske efikasnosti (HDR)	F	
6. Snaga u uključenom stanju za mod velikog dinamičkog raspona (HDR), ako je primenljivo	77.0	W
7. Snaga u isključenom stanju, ako je primenljivo		W
8. Snaga u stanju pripravnosti, ako je primenljivo	0.4	W
9. Snaga u umrežanom stanju pripravnosti, ako je primenljivo		W
10. Kategorija elektronskog ekrana	Televizor	
11. Odnos veličina	16 : 9	
12. Rezolucija ekrana (u pikselima)	3840 x 2160	piksela
13. Dijagonala ekrana	55.0	inča
14. Dijagonala ekrana	140.0	cm
15. Vidljivo područje ekrana	82.3	dm ²
16. Tehnologija panela koja se koristi	LCD sa LED	
17. Automatska regulacija sjajnosti (ABC) koja je dostupna	Ne	
18. Senzor za prepoznavanje glasa koji je dostupan	Ne	
19. Senzor prisutnosti u prostoriji koji je dostupan	Ne	
20. Učestalost osvežavanja slike (zadata postavka)	60	Hz
21. Minimalna garantovana raspoloživost ažuriranja softvera i integrisanog softvera uređaja, ako je propisana, od datuma završetka stavljanja na tržište do	3	godina
22. Minimalna garantovana raspoloživost rezervnih delova, ako je propisana, od datuma završetka stavljanja na tržišt do	3	godina
23. Minimalno trajanje opšte garancije koju daje isporučilac	3	godina
24. Vrsta napajanja:		
25. Spoljašnje napajanje (priloženo uz proizvod, nije standardizovano)		
i.		
ii.	Ulazni napon	V
iii.	Izlazni napon	V
26. Spoljašnje standardizovano napajanje (ako nije priloženo uz proizvod, drugo odgovarajuće napajanje)		
i.		
ii.	Potreban izlazni napon	V
iii.	Potrebna jačina struje (minimalna)	A
iv.	Potrebna frekvencija struje	Hz

Tehničke karakteristike : napajanje 100-240 Vac 50/60Hz
snaga potrošnje : 108 W

SADRŽAJ

Informacija o bezbednosti
Jezik
Region
Podešavanja pristupačnosti
Kako da podesite TV
Internet konekcija
Lozinka
Odredbe i uslovi
Analiza okruženja korisnika
Vrsta Instalacije uređaja
Podešavanje kanala
Automatsko podešavanje

Početna instalacija

Početni ekran

Vodič

Pretraga

Podešavanja

Obaveštenja

Nalog

Podešavanja

Sva podešavanja

Pristupačnost

Veza

Internet

Režim uređivanja

Režim rada

Sva podešavanja

Slika

Zvuk

Opšte

Podrška

Multimedia

Fotografija

Video

Muzika

Bezbednost

Detaljno pročitajte ova uputstva pre korišćenja TV-a.

Sačuvajte ovo uputstvo, popunjen garantni list kao i kutiju od uređaja. Mere bezbednosti smanjuju rizik od požara, električnog šoka i povreda ako se pročita do kraja i pridržava upozorenja.

Molimo Vas pratite sva uputstva i upozorenja!



Poklopac (ili zadnji deo) uređaja ne treba skidati da biste sprečili rizik od strujnog udara.

Ovaj uređaj mora servisirati samo kvalifikovano servisno osoblje.



Simbol munje unutar trougla ima za cilj da Vas upozori na neizolovani opasni napon u kućištu proizvoda koji može biti dovoljne jačine da stvori rizik od strujnog udara.



Uzvičnik unutar trougla ima za cilj da vas upozori na prisustvo važnih uputstava za rad i održavanje u dokumentima priloženim uz proizvod.

VAŽNE INFORMACIJE!

- Koristite komodu ili postolje koje preporučuje proizvođač televizora.
- Koristite samo nameštaj koji može bezbedno da podrži proizvode.
- Uverite se da proizvod ne visi preko ivice nosećeg nameštaja.
- Ne postavljajte proizvod na visok nameštaj bez pričvršćivanja proizvoda za stabilan oslonac.
- Ne stavljajte tkaninu na proizvod ili druge provodne materijale.
- Upozorite decu na opasnosti penjanja na nameštaj da bi došla do televizora ili njegovih komandi.

OPŠTA BEZBEDNOSNA UPUTSTVA

VAŽNE INFORMACIJE

- Ne izlažite ovaj uređaj kiši ili vlazi jer to može dovesti do požara ili strujnog udara.
- Nemojte menjati ili modifikovati proizvod na bilo koji način.
- Koristite samo dodatnu opremu koju je naveo i preporučio proizvođač.
- Ne izlažite proizvod prskanju ili kontaktu sa vodom
- Nemojte stavljati nikakve predmete na proizvod, uključujući predmete napunjene tečnošću, kao što su vaze.
- Opasnost od eksplozije ako je baterija pogrešno postavljena. Zamenite je istom ili ekvivalentnom vrstom.

Instalacija

Molimo Vas da pratite uputstva kada instalirate ovaj proizvod u skladu sa uputstvom za upotrebu. Ovaj proizvod mora biti postavljen na dovoljno stabilnoj lokaciji, može biti potencijalno opasan zbog pada i može izazvati povrede, posebno kod dece ako se nepravilno postavi.

Pre instaliranja ovog televizora, uverite se da napon na Vašoj utičnici

- *odgovara naponu navedenom na nalepnici proizvoda. Nemojte koristiti oštećeni kabl za napajanje, utikač ili labavu utičnicu. To može izazvati strujni udar.*
- *Nemojte uključivati nekoliko uređaja u istu utičnicu. To može dovesti do pregrevanja utičnice i izazivanja požara. Uverite se da je utičnica lako dostupna tokom rada opreme.*
- *Nemojte preterano uvrtati kabl za napajanje.*
- *Ne dozvolite da se bilo šta naslanja na kabl za napajanje ili antenski kabl ili da prelazi preko njega. To može izazvati požar ili strujni udar.*
- *Ne provlačite kabl za napajanje u blizini uređaja koji proizvode toplotu, kao što su radijatori, peći ili pegle. Prekomerna toplota može da istopi izolaciju i izloži žice pod naponom, što može dovesti do požara ili strujnog udara.*
- *Isključite ovaj televizor iz struje tokom oluja sa grmljavinom ili kada ga ne koristite duže vreme. Ako to ne uradite, to može dovesti do požara ili strujnog udara.*
- *Nemojte prekrivati ventilacione otvore proizvoda predmetima kao što su novine, stolnjaci, zavese itd. niti umetati predmete u otvore na proizvodima jer to može dovesti do porasta temperature proizvoda i može izazvati požar.*
- *Ako primetite neobične mirise ili dim oko uređaja, odmah isključite uređaj iz utičnice i kontaktirajte servisni centar.*
- *Ako to ne uradite, može doći do požara ili strujnog udara.*
- *Kada ne koristite uređaj duži vremenski period ili kada je pomerate, obavezno izvucite kabl za napajanje iz zidne utičnice.*

OPŠTA BEZBEDNOSNA UPUTSTVA

- Imajte na umu da se prašina može akumulirati tokom vremena na uređaju i uzrokovati njegovo pregrevanje i/ili pogoršanje izolacije, što zauzvrat može dovesti do električnog požara.
- Proizvod nije namenjen za upotrebu od strane osoba (uključujući decu) sa smanjenim fizičkim, senzornim ili mentalnim sposobnostima. Proizvod mora biti pod nadzorom osobe odgovorne za njihovu bezbednost.
- Baterije iz daljinskog upravljača sme da izvadi samo odrasla osoba, odrasla osoba mora da obezbedi da ih drži van domašaja beba i dece. Odmah potražite medicinsku pomoć ako je dete progutalo bateriju.
- Baterije (paket baterija ili instalirane baterije) ne smeju biti izložene preteranoj toploti kao što je sunce, vatra ili slično.
- Da biste održavali proizvod, ne koristite nikakve hemikalije ili sredstva za čišćenje ili mokru krpu. Molimo Vas da koristite samo suhu krpu da biste obrisali uređaj od prašine, i to tek nakon što isključite proizvod iz električne utičnice.
- Obavezno kontaktirajte naš pozivni centar za bilo kakvu popravku ili uslugu koja je potrebna za proizvode.

UPOZORENJE!

STROGO PREPORUČUJEMO da ovaj proizvod POSTAVITE STABILNO.

Rušenje nameštaja i televizora može izazvati ozbiljne povrede.

KAKO BI SE IZBEGLE BILO KAKVE OZBILJNE ILI SMRTONOSNE POVREDE, PREPORUČUJEMO DA OVAJ PROIZVOD BUDE TRAJNO FIKSIRAN NA ZID ILI NA DRUGU ODGOVARAJUĆU POVRŠINU. UREĐAJI ZA FIKSIRANJE NISU UKLJUČENI UZ PROIZVOD POŠTO RAZLIČITI POVRŠINSKI MATERIJALI ZAHTEVAJU RAZLIČITE TIPOVE PRIKLJUČAKA. MOLIMO VAS ZATRAŽITE STRUČNI SAVET AKO STE U SUMNJI KOJI UREĐAJ ZA FIKSIRANJE DA KORISTITE.

Ako televizor nije postavljen na dovoljno stabilnu lokaciju, može biti potencijalno opasan zbog pada. Mnoge povrede, posebno kod dece, mogu se izbeći preduzimanjem jednostavnih mera predostrožnosti kao što su:

- Korišćenje ormara ili postolja koje preporučuje proizvođač televizora.
- Koristite samo nameštaj koji može bezbedno da izdrži televizor.
- Uverite se da televizor ne visi preko ivice nosećeg nameštaja.
- Edukacija dece o opasnostima penjanja na nameštaj kako ne bi došla do televizora ili njegovih kontrola.

OPŠTA BEZBEDNOSNA UPUTSTVA

Uverite se prilikom pozicioniranja ovog proizvoda, da je mesto:

- Suvo i dobro provetreno
- Dalje od direktne sunčeve svetlosti ili grejača.
- Dalje od prskanja tečnost ili hrane.
- Zaštićeno od prekomerne prašine ili masnoće.
- Ne postavljajte ovaj proizvod u skućeni prostor kao što je policica za knjige ili slična jedinica.
- Ne postavljajte televizor u blizini izvora toplote kao što su radijatori, peći ili drugi audio uređaj i vizuelna oprema koja proizvodi toplotu.
- Ne stavljajte posude sa tečnostima na uređaj, ako tečnost upadne u proizvod, to može dovesti do kratkog spoja, požara ili strujnog udara.
- Ne stavljajte male metalne predmete unutar uređaja, to može dovesti do kratkog spoja, požara ili strujnog udara.
- Nemojte koristiti ili skladištiti zapaljive materijale u blizini uređaja. To može dovesti do požara ili eksplozije. Ne stavljajte izvore otvorenog plamena, kao što su upaljene sveće, cigarete ili mirisni štapići na televizor.
- Antena mora biti postavljena dalje od visokonaponskog dalekovoda,
- Obratite se profesionalnom instalateru antene da instalira antenu kako biste izbegli pogrešnu instalaciju koja može dovesti do požara, strujnog udara ili ozbiljnih povreda.
- Instalirajte uređaj na razumnoj udaljenosti od zida kako biste obezbedili dovoljnu ventilaciju.
- Ako se utikač za napajanje koristi kao uređaj za isključivanje, treba da bude u ispravnom stanju.



„Termini HDMI i HDMI High-Definition Multimedia Interface, komercijalni izgled HDMI i logotipi HDMI su zaštitni znakovi ili registrovani zaštitni znakovi u vlasništvu kompanije HDMI Licensing Administrator, Inc.“

INSTALACIJA

Instalirajte postolje kao što je opisano u nastavku, ili ako želite da ga montirate na zid, obratite se profesionalnom instalateru.

Uverite se da televizor nije uključen u zidnu utičnicu i pored toga preporučujemo da pozovete drugu osobu koja će Vam pomoći u sledećem zadatku.

Pričvršćivanje postolja

Korak 1

Na sto stavite mekani obloženi materijal ravne površine kako biste sprečili oštećenje panela ekrana. Zatim postavite TV ekran na obloženi materijal, sa stranom ekrana okrenutom nadole, kao što je prikazano na desnoj strani.

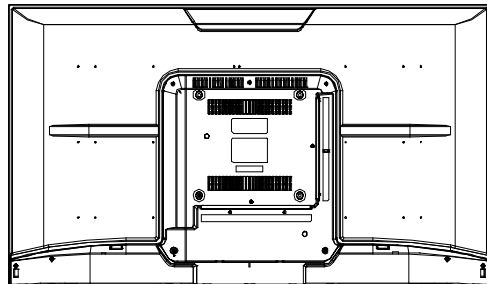

Korak 2

Poravnajte nogu postolja sa rupom ugradnje, kao što je prikazano na desnoj strani.



Korak 3

Zategnite šrafove (isporučene) pomoću odvijača da biste pričvrstili postolje na uređaj, kao što je prikazano na desnoj strani.

OPREZ!

Nemojte primenjivati preteranu silu jer to može oštetiti rupe za šrafove.

INSTALACIJA

Uputstva za montažu na zid

Uverite se da televizor nije uključen u zidnu utičnicu i pored toga preporučujemo da pozovete drugu osobu koja će Vam pomoći u sledećem zadatku.

- Preporučujemo vam da koristite profesionalnog instalatera jer ne preuzimamo odgovornost za eventualnu štetu koja može nastati na proizvodu ili povredu ako sami montirate televizor.

POZADINA TV-A 55inča

VESA standard: 200 x 200 mm

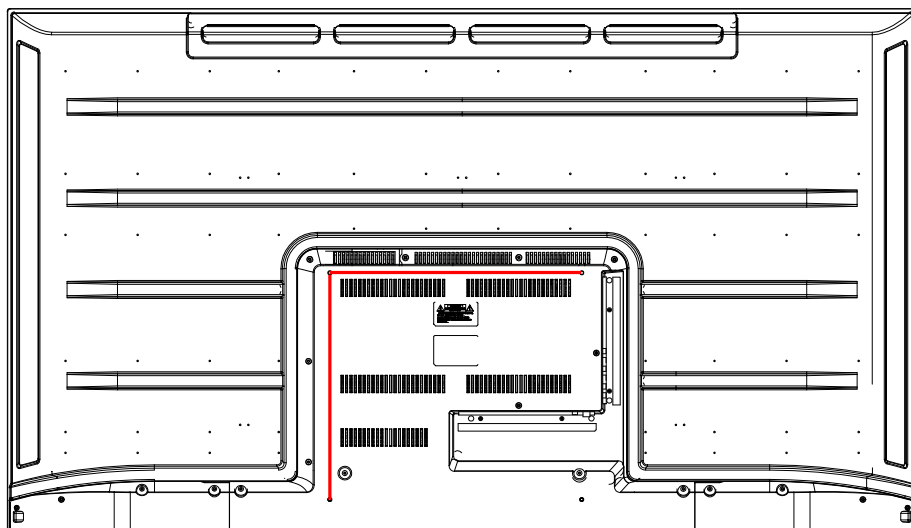

NAPOMENA

Ako televizor montirate na zid, to bi trebalo da uradi kvalifikovani instalater.

KONTROLE I KONEKCIJE

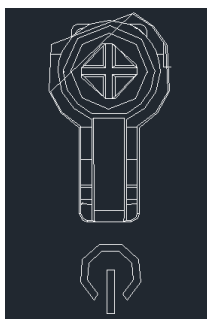
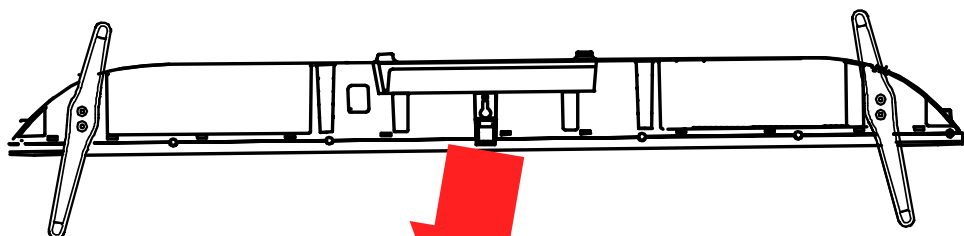

KONTROLE I KONEKCIJE

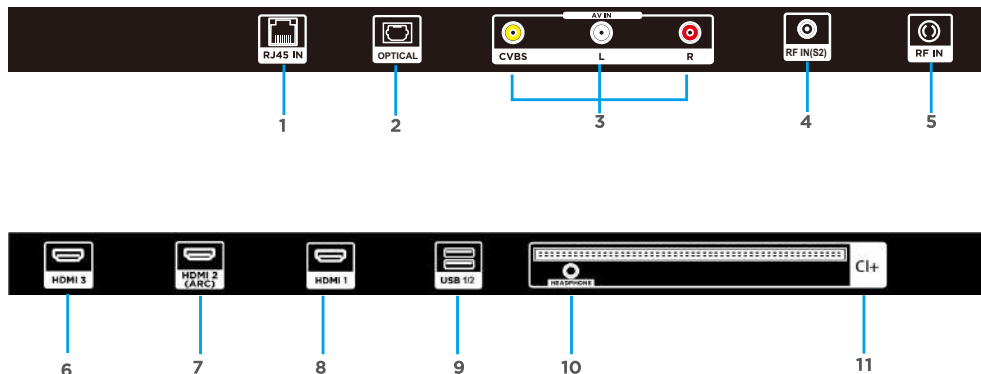

1. RJ45 (ETHERNET)
2. OPTIČKI IZLAZ
3. CVBS/ AUDIO LEVO I DESNO
4. RF IN (SATELIT)
5. RF IN (ANTENA)
6. HDMI 3
7. HDMI 2 (ARC)
8. HDMI 1
9. USB ULAZ*2
10. IZLAZ ZA SLUŠALICE
11. CI+
11. USB

Priključite USB uređaj u USB port za snimanje i reprodukciju video zapisa/fotografije/muzike

MAGIČNI DALJINSKI UPRAVLJAČ



Sledećih nekoliko stranica MAGIČNI DALJINSKI UPRAVLJAČ objašnjava sledeće:

- Uparivanje prvi put sa uređajem
- Ponovno registrovanje Magičnog daljinskog upravljača

MAGIČNI DALJINSKI UPRAVLJAČ

Pratite uputstva kada uparujete magični daljinski upravljač za Vaš webOS TV.

Vaš pametni TV radi sa Magičnim daljinskim upravljačem koji služi kao kursor i daljinski upravljač za ekran koji vam omogućava da upravljate svojim pametnim TV-om i spoljnim uređajima povezanim sa Vašim pametnim TV-om.

Možete da koristite Magični daljinski upravljač kao kursor da biste izabrali i pokrenuli sadržaj na svom pametnom TV-u. Magični daljinski upravljač takođe podržava glasovne komande (Think AI) i pokrete kako bi vam omogućio zgodan pristup raznim funkcijama pametnog TV-a.

PRVO UPARIVANJE

Registrowanje Magičnog daljinskog upravljača

Morate registrovati Magični daljinski upravljač na svom pametnom TV-u kada ga koristite prvi put. Da biste registrovali svoj Magični daljinski upravljač pomoću tastera **Točak (OK)**, izvršite sledeće korake:

1. Uključite svoj pametni TV.
2. Sačekajte 10 sekundi dok se vaš pametni TV uključi.
3. Usmerite Magični daljinski upravljač na pametni TV, a zatim pritisnite taster **Točak (OK)**. Poruka se pojavljuje nakon što je Magični daljinski upravljač registrovan.

- Ako se Magični daljinski upravljač ne registruje, Vaš pametni TV isključite i ponovo uključite i ponovite proces registracije.

MAGIČNI DALJINSKI UPRAVLJAČ

PONOVNA REGISTRACIJA MAGIČNOG DALJINSKOG UPRAVLJAČA



Ako Magični daljinski upravljač ne radi ispravno, **morate** ga ponovo registrovati. Koristite taster **Smart Home** (🏠) i taster **BACK** (↶) na Magičnom daljinskom upravljaču. Da biste ponovo registrovali Magični daljinski upravljač, izvršite sledeće korake:

1. Držite pritisnuti taster **Smart Home** (🏠) i taster **BACK** (↶) na Magičnom daljinskom upravljaču 5 sekundi da biste pokrenuli Magični daljinski upravljač.
2. Usmerite Magični daljinski upravljač na vaš **pametni TV**, a **zatim pritisnite taster Točak (OK)**. Poruka se pojavljuje nakon što je Magični daljinski upravljač registrovan.

Napomena: Usmerite Magični daljinski upravljač na Vaš **pametni TV**, a **zatim držite pritisnuto taster BACK** (↶) 5 sekundi da ponovo registrujete Magični daljinski upravljač

MAGIČNI DALJINSKI UPRAVLJAČ

Korišćenje magičnog daljinskog upravljača:

- Baterija bi normalno trebalo da traje godinu dana u normalnim/predviđenim okolnostima.
- Nemojte mešati stare i nove baterije u daljinskom upravljaču
- Nemojte koristiti različite tipove baterija
- Ako ne nameravate da koristite uređaj duže vreme, izvadite baterije iz daljinskog upravljača da biste izbegli nezgodu.
- Držite baterije dalje od dece i kućnih ljubimaca.
- Nikada ne bacajte baterije u vatru.
- Nemojte ispuštati ili udarati daljinski upravljač jer to odmah poništava garanciju.
- Daljinski upravljač efikasno radi u opsegu od 5 do 6 metara.
- Ne izlažite senzor daljinskog upravljača jakom svetlu.

OTVARANJE ODJELJAKA ZA BATERIJE DALJINSKOG DA BISTE ZAMENILI BATERIJE

1. Okrenite daljinski upravljač na poledinu.
2. Pritisnite i povucite odeljak za bateriju kako biste otvorili poklopac.
3. Stavite 2k AA baterije (isporučene) u odeljak za baterije i obavezno poklapajte polaritete (+/-) označene na odeljku za baterije.
4. Zatvorite odeljak za baterije. Uverite se da klikne pri zatvaranju.

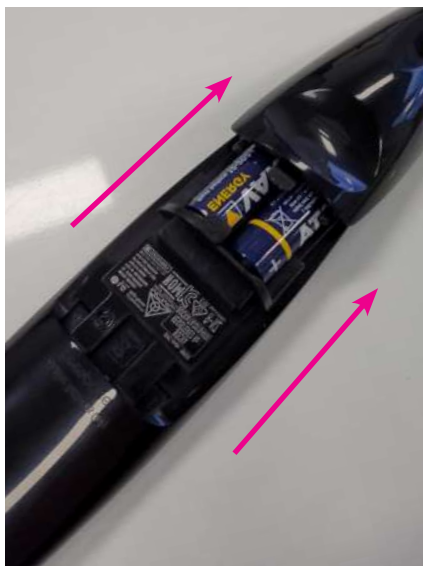

POČETNA INSTALACIJA



Jezik

Izaberite jezik koji želite.



Region

Izaberite region (državu) u kom se nalazite.



Podešavanja pristupačnosti

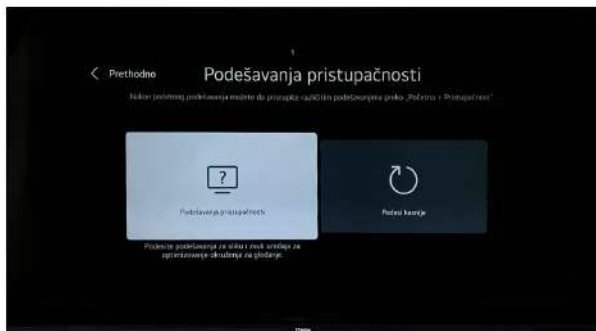

Kako da podesite TV

Izaberite polje uz pomoć daljinskog upravljača.



Internet konekcija

Povežite Vaš uređaj sa wi-fi konekcijom ili kablom.

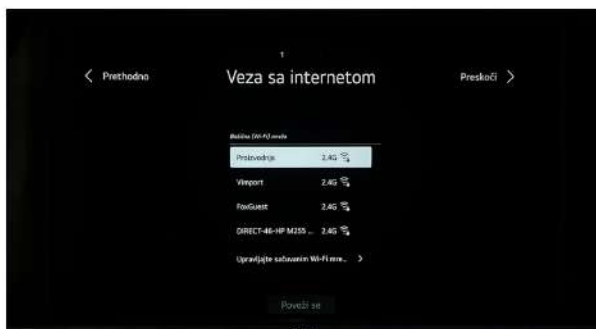

Lozinka

Unesite tačnu lozinku wi-fi konekcije.



Odredbe i uslovi

Da biste mogli da koristite usluge i funkcije Smart TV-a, morate da prihvatite Odredbe i uslove.



Analiza okruženja korisnika

Automatska provera .



Analiza okruženja korisnika

Izaberite način na koji gledate.

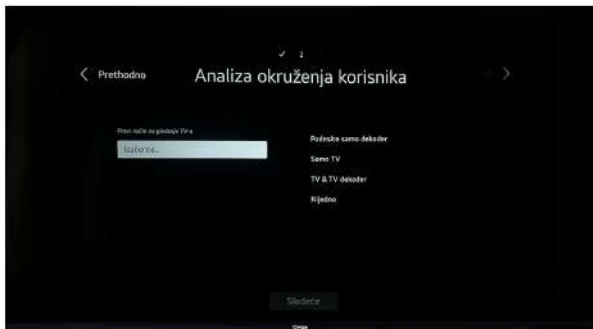

Vrsta instalacije uređaja

Izaberite način na koji ćete postaviti uređaj.



Uvek spremno

Podesite režim Uvek spremno i uživajte u posebnoj iskustvu čak i kada isključite TV.

TV-om možete da upravljate pomoću glasovnih komandi u režimu Uvek spremno.

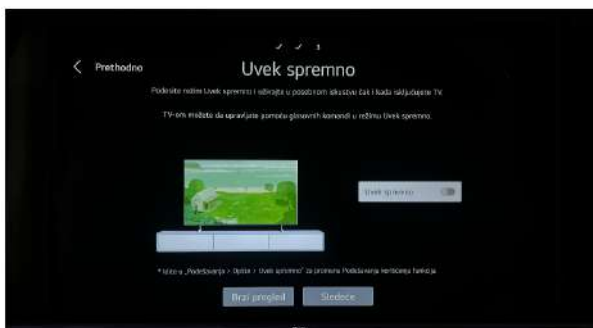

Podešavanje kanala

Izaberite režime podešavanja kanala.

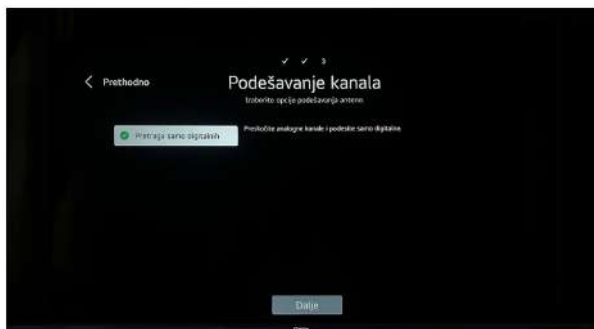
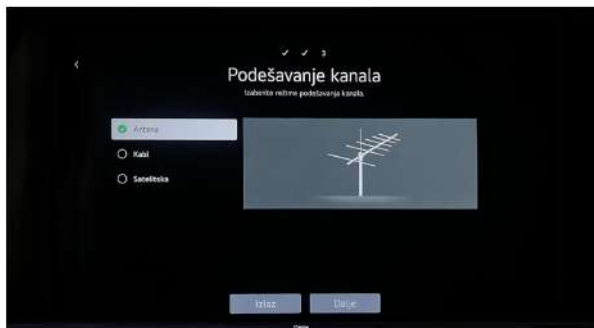

Automatsko podešavanje



POČETNI EKLAN

Početni ekran

Kada završite početnu instalaciju, ulazite na glavni ekran.

(Opcije: Vodič / Pretraga / Podešavanja / Obaveštenja / Nalog)

- Vodič
- Pretraga
- Podešavanja
- Obaveštenja
- Nalog



Podešavanja

Pritiskom na tastere [▼][▲][◀][▶] birte opciju, a tasterom OK ulazite na izabranu opciju:

Opcije uključuju:

- Sva podešavanja
- Pristupačnost
- Internet
- Režim uređivanja
- Nedavna istorija
- Režim slike
- Osvetljenje panela
- Režim zvuka
- Izlaz zvuka
- Tajmer za mirovanje
- Režim zaštite očiju
- Isključivanje ekrana
- Optimizator igre



Sva podešavanja

Pritisnite tastere [▼][▲][◀][▶] da izaberete, i taster OK da uđete:

- Slika
- Zvuk
- Opšta
- Podrška



Slika (Picture)

Pritisnite **【▼】** / **【▲】** taster da izaberete Slika(Picture), I pritisnite taster **【OK】** ili **【▶】** taster da uđete u izabranu opciju

Birate opcije:

- **Izbor režima**
- **Odnos širine i visine (Aspect Ratio)**
- **Napredna podešavanja**

Izaberite odgovarajući režim slike u zavisnosti od okruženja za gledanje ili tipa sadržaja.

Pritisnite **【▼】** / **【▲】** taster da izaberete željeni režim, I pritisnite **【OK】** taster da potvrdite izbor

Izbor režima slike:

- **Vivid** – jača kontrast, osvetljenje i oštrinu
- **Standard** – visok kvalitet slike u standardnim uslovima
- **Basic** – osnovni prikaz
- **Cinema** – optimalno za filmove
- **Sports** – optimizovano za sport
- **FILMMAKER MODE** – čuva izvorni izgled sadržaja (bez obrade slike)

Zvuk (Sound)

Pritisnite **【▼】** / **【▲】** taster da izaberete Zvuk (Sound), I pritisnite **【OK】** ili **【▶】** da uđete na opciju.

Birate opcije:

- **Izbor režima zvuka**
- **Izlaz zvuka**
- **Napredna podešavanja**



Možete izabrati najbolji režim zvuka za bilo koju vrstu sadržaja koju želite da gledate.

Pritisnite **【▼】** / **【▲】** taster da izaberete Režim zvuka (Sound mode), I pritisnite **【OK】** ili **【▶】** da uđete na opciju

Režimi zvuka:

- **Standard** – izbalansiran
- **Cinema** – više basa i visokih tonova
- **Clear Voice** – jača glas, umanjuje pozadinske zvuke
- **Sports** – pojačava glas i ambijentalne zvuke
- **Music** – za slušanje muzike, pojačava bas i visoke tonove

Vodič (Guide)

Pritiskom na tastere **[▼][▲][◀][▶]** birte opciju, a tasterom OK ulazite na izabranu opciju:

- **Vodič**
- **Programi**
- **Redosled programa**

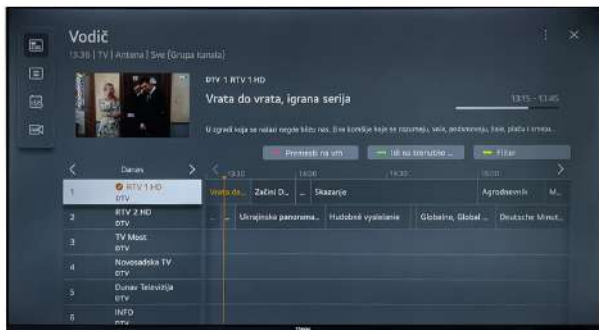

Multimedija

- **Fotografija**
- **Video**
- **Muzika**



OPŠTA PODEŠAVANJA

Pritisnite [▼]/[▲] taster da izaberete Opšta podešavanja (General), i pritisnite [OK] ili [▶] da uđete na opciju

Opcije uključuju:

- **Pristupačnost**
- **Uvek spreman (Always Ready)**
- **AI servis**
- **Optimizator igre**
- **Briga o korišćenju**
- **Programi**
- **Mreža**
- **Spoljni uređaji**
- **Sistem**
- **Ušteda energije**

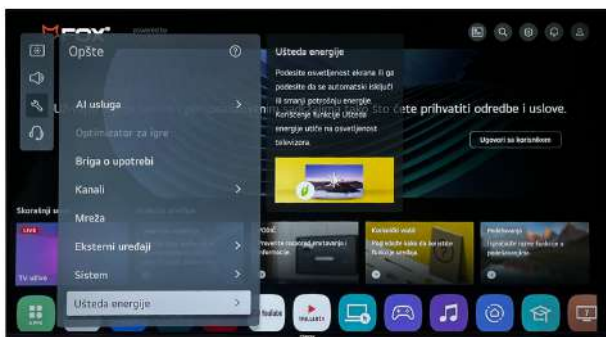

Pristupačnost (Accessibility)

Pritisnite [▼]/[▲] taster da izaberete Pristupačnost (Accessibility), pa pritisnite [OK] taster da uđete na izabrano.

Opcije:

- **Vodič putem zvuka**
- **Audio opis**
- **Jačina zvuka opisa**
- **Učenje daljinskog**
- **Produženo vreme pritiska na taster**
- **Zvuk uključivanja**
- **Zumiranje ekrana**
- **Slušanje uz slušni aparat**
- **Za osobe sa oštećenim sluhom**
- **Subtitlovi**
- **Tekst visokog kontrasta**
- **Fokus visokog kontrasta**
- **Siva slika**
- **Inverzija boja**

Audio vodič (Audio Guidance)

Ova funkcija daje nazive menija ili status uređaja putem zvuka. Uključite ovu funkciju da biste se kretali samo uz pomoć tastera za navigaciju na daljinskom.

Pritisni **[▼]/[▲]** taster da izaberete Audio vodič (Audio Guidance), pa pritisnite **[OK]** taster da uđete na izabrano.

Opisuje stavke menija glasom. Možeš uključiti/isključiti, podesiti brzinu, jačinu, ton i kvalitet.

Pritisni **[▼]/[▲]** taster da izaberete Uključi funkciju (Enable the function), pa pritisnite **[OK]** taster da uključiš ili isključiš funkciju.



PROGRAMI

Podešavanje TV kanala i prenosa
Pritisnite [OK] taster da izaberete:

- **Podešavanje i pretraga programa**
- **Menadžer programa**
- **Mono podešavanje**
- **CI informacije (Common Interface)**
- **Kopiranje programa**
- **HbbTV**



Podešavanje programa (Program Tuning)

Podesite i sačuvajte dostupne programe. Možete postaviti opcije satelitskog programa.

Pritisnite [OK] taster da izaberete

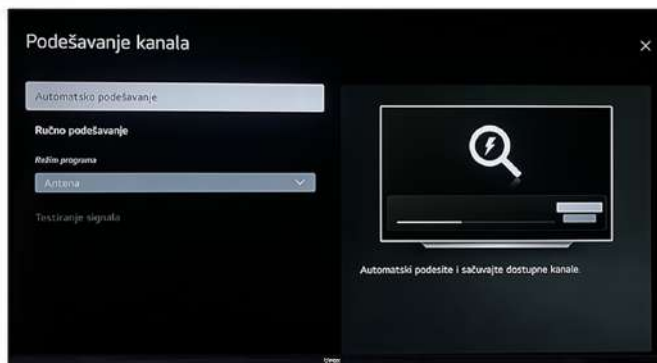

Režim programa

Izaberite režim programa sa antene, kabla, satelita i drugih izvora

Pritisnite [OK] taster da izaberete

Opcije: antena / kabl / satelit

- Automatsko podešavanje programa

Automatski podesite i sačuvajte dostupne programe.

Pritisnite taster **[OK]** da uđete u režim podešavanja programa.

Pritiskom na tastere **[▼]/[▲]** izaberite 'Antena', zatim pritiskom na **[◀]/[▶]** izaberite 'Dalje' i ponovo pritisnite **[OK]** da pređete na sledeći korak.

Pritiskom na tastere **[▼]/[▲]** izaberite opcije podešavanja, zatim pritiskom na **[◀]/[▶]** izaberite 'Dalje', i pritisnite **[OK]** da započnete pretragu.

(Opcije: Pretraga samo digitalnih kanala / Pametno ponovno podešavanje).



- DTV antena

Pritiskom na tastere **[▼]/[▲]** izaberite opcije podešavanja, zatim ponovo koristite **[▼]/[▲]** da izaberete „Ažuriraj“, i pritisnite **[OK]** da započnete pretragu.

(Opcije: UHF kanal / Frekvencija (kHz) / Širina pojasa (MHz))

TV antena

Pritiskom na tastere **[▼]/[▲]** izaberite opcije podešavanja, zatim koristite

[▼]/[▲] da izaberete „Pretraga nagore“ / „Pretraga nadole“, i pritisnite **[OK]** da započnete pretragu.

(Opcije: Memorija / Sistem / Opseg / Program / Naziv)

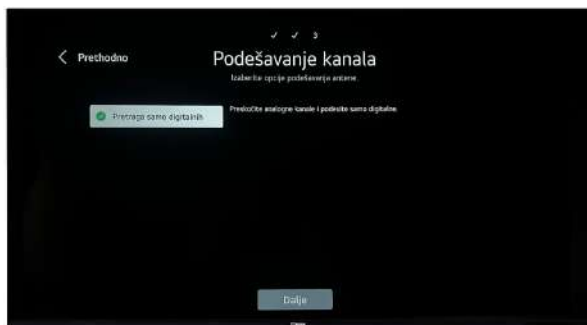

- Auto podešavanje kablovske:

Automatski podesite i sačuvajte dostupne programe.

Pritisnite taster **[OK]** da uđete u režim podešavanja programa.

Pritiskom na tastere **[▼]/[▲]** izaberite 'Kablovska', zatim pritiskom na **[◀]/[▶]** izaberite 'Dalje' i pritisnite **[OK]** da pređete na sledeći korak.

Pritiskom na tastere **[◀]/[▶]** izaberite podešavanja za kablovsku, zatim koristite **[▼]/[▲]** da izaberete 'Dalje' i pritisnite **[OK]** da pređete na sledeći korak.

(Opcije: Brza pretraga / Mrežna pretraga / Potpuna pretraga)

Pritiskom na tastere **[▼]/[▲]** izaberite opcije podešavanja, zatim koristite **[◀]/[▶]** da izaberete 'Dalje' i pritisnite **[OK]** da započnete pretragu.

(Opcije: Pretraga samo digitalnih kanala / Preskoči kodirane programe.)

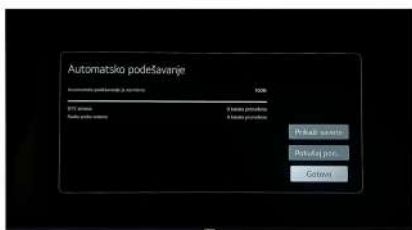

- Ručna pretraga kablovske

Ručno podesite i sačuvajte programe.

Pritisnite taster **[OK]** da uđete u izbor tipa podešavanja programa.

Pritiskom na tastere **[▼]/[▲]** izaberite tip podešavanja, zatim pritisnite **[OK]** da pređete na sledeći korak.

(Opcije: Kablovska DTB / Kablovska TV).



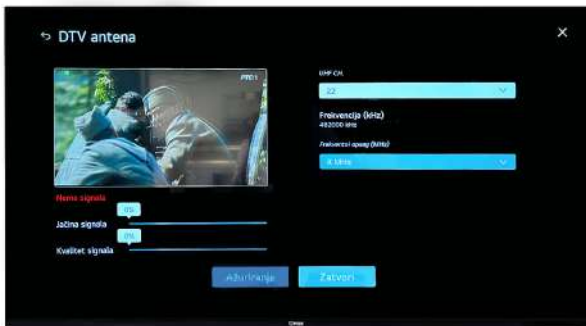

- Kablovska DTV

Pritisnite taster **【▼】/【▲】** da izaberete opcije podešavanja, zatim pritisnite taster **【▼】/【▲】** da izaberete ažuriranje, i pritisnite taster **【OK】** za podešavanje. (Opcije: Frekvencija (kHz) / Brzina simbola (kS/s) / Modulacija)

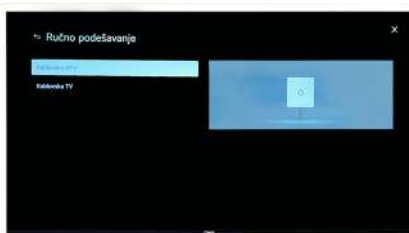

Kablovska TV

Pritisnite tastere [▼]/[▲] da izaberete opcije podešavanja, zatim pritisnite tastere [▼]/[▲] da izaberete pretragu gore/pretragu dole, i pritisnite taster [OK] za podešavanje.

(Opcije: Memorija / Sistem / Opseg / Program / Ime)

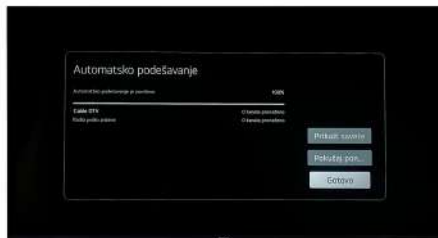

- Automatsko podešavanje satelita

Automatski pronađi i sačuvaj dostupne programe

Pritisnite taster [OK] da uđete u režim podešavanja programa, pritisnite tastere [▼]/[▲] da izaberete Satelit, zatim pritisnite tastere [◀]/[▶] da izaberete Sledeće i pritisnite taster [OK] da pređete na sledeći korak.

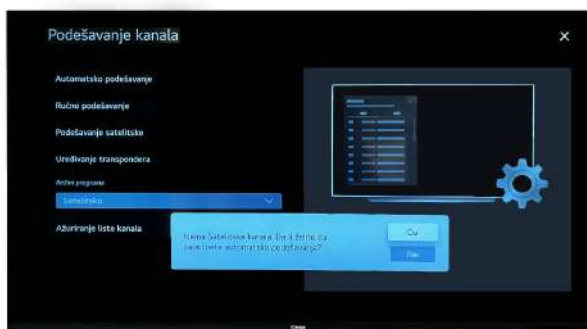

Pritisnite tastere [▼]/[▲] da izaberete operatera satelitske usluge, zatim pritisnite tastere [◀]/[▶] da izaberete Sledeće i pritisnite taster [OK] za podešavanje.

(Opcije: Freesat / Ostali operateri)

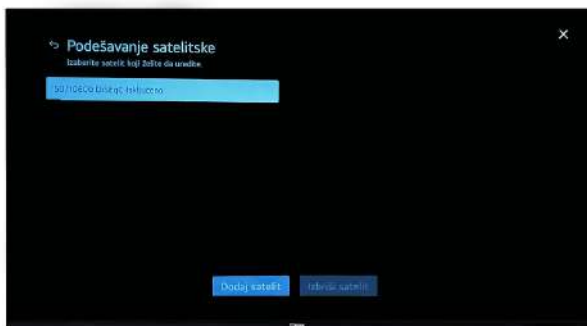

- Podešavanje satelita

Podesite podešavanja satelita.

Pritisnite taster **[OK]** da uđete u podešavanja satelita, pritisnite taster **[OK]** da izmenite podešavanja satelita.

(Opcije: Satelit / LNB frekvencija / Transponder / 22 kHz ton / LNB napajanje / DiSEqC / Unicable / Unicable podešavanja / Tip motora / Podešavanja motora)

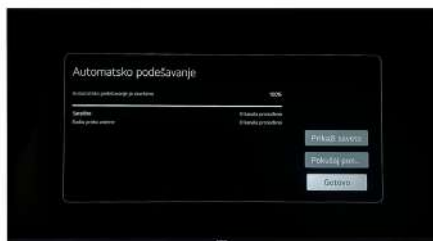

- Menadžer programa

Upravljanje programima sačuvanim na TV-u

Pritisnite tastere **[▼]** / **[▲]** da izaberete Menadžer programa, atim pritisnite taster **[OK]** za ulazak.

(Opcije: Izmeni sve programe / Izmeni omiljene / Zaključaj / Otključaj / Preskoči / Vrati)

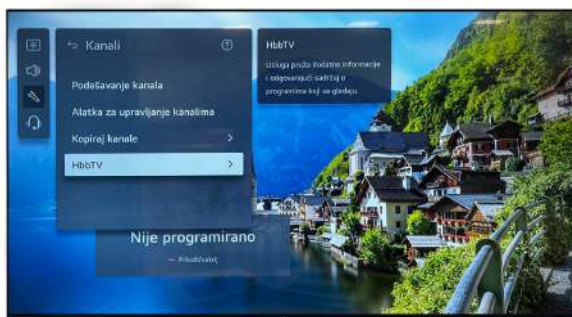

- Mono podešavanje

Možete izabrati podešavanja levog i desnog audio kanala za emitovani signal. Pritisnite tastere [▼]/[▲] da izaberete Dual Mono, zatim pritisnite taster [OK] za ulazak.

(Opcije: L+L / R+R / L+R)



- CI informacije (Common Interface)

Prikaži trenutne informacije Common Interface (CI).

Pritisnite tastere [▼]/[▲] da izaberete CI informacije, zatim pritisnite taster [OK] za ulazak.



- Kopiranje programa

Uvezi/izvezi listu programa sa TV-a na povezani USB uređaj ili sa njega. Pritisnite tastere **【▼】/【▲】** da izaberete Kopiraj programe, zatim pritisnite taster **【OK】** za ulazak.

(Opcije: USB skladište za kopiranje programa / TV na USB / USB na TV)

- HbbTV

Usluga pruža dodatne informacije i relevantan sadržaj o programima koji se gledaju.

Pritisnite tastere **【▼】/【▲】** da izaberete HbbTV, zatim pritisnite taster **【OK】** za ulazak.

(Opcije: Automatski start / Ne pratiti / Pružanje jedinstvenog HbbTV ID / Resetuj jedinstveni HbbTV ID / Obrisij istoriju konekcija / Audio za više programa / Kolačići trećih strana)

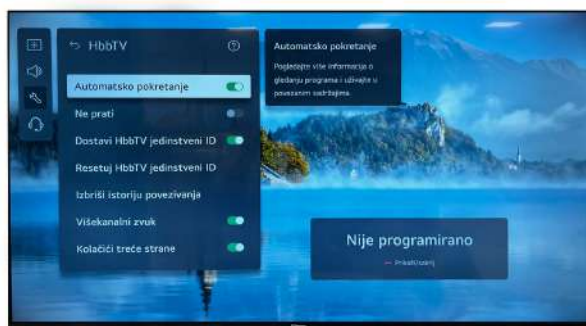

- Mreža (Network)

Podesite podešavanja vezana za Vašu žičnu/bežičnu mrežu.

Pritisnite taster **【OK】** za ulazak na izabranu opciju.

MULTIMEDIJA (Media)

Povežite USB uređaj za skladištenje na USB port na TV-u kako biste uživali u sadržaju sačuvanom na USB uređaju.

Pritisnite tastere **[▼]/[▲]** da izaberete tip.

(Opcije: Sve / Fotografije i video / Fotografije / Video / Muzika)



- Foto

Pritisnite tastere **[▼]/[▲]/[◀]/[▶]** da izaberete fotografiju, pritisnite taster **[OK]** da pokrenete prikaz.

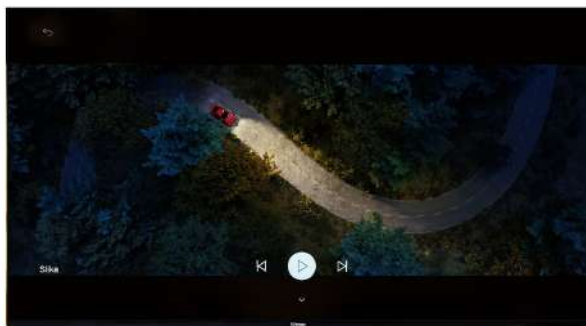

Pritisnite taster **[▼]** da izaberete opciju, pritisnite taster **[OK]** da uđete.
(Opcije: Rotiraj / Uvećaj / 360° VR prikaz / Pozadinska muzika / Opcije)

- Video

Pritisnite tastere **【▼】/【▲】/【◀】/【▶】** da izaberete video, pritisnite taster **【OK】** da pokrenete reprodukciju.



Pritisnite taster **【▼】** da izaberete opciju, pritisnite taster **【OK】** da uđete.
(Opcije: Titl / Rotiraj / Premotaj unazad / Ponavlaj sve / Brzo premotavanje / 360° VR prikaz / Opcije)

- Muzika

Pritisnite tastere **【▼】/【▲】/【◀】/【▶】** da izaberete muziku, pritisnite taster **【OK】** da pokrenete reprodukciju.

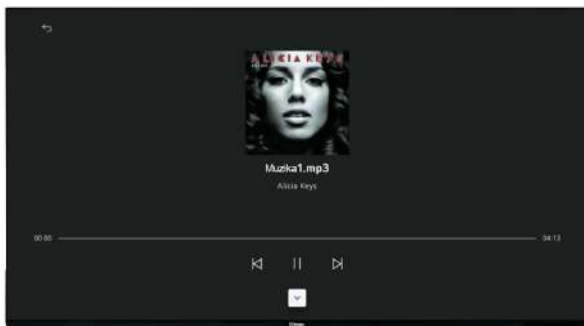

Pritisnite taster **【▼】** da izaberete opciju, pritisnite taster **【OK】** da uđete.
(Opcije: Mešanje / Bez ponavljanja / Tekst pesme / Isključi ekran)

Često postavljana pitanja neispravnog rada televizora

Simptomi	Provera i rešenje
„duh“ ili dvostruka slika	Ovo može biti uzrokovano opstrukcijom antene zbog visokih zgrada ili brda. Korišćenje visoko usmerene antene može poboljšati sliku.
Nema struje	<ul style="list-style-type: none">• Proverite da li je kabl za napajanje TV-a uključen u utičnicu.• Isključite TV, sačekajte 60 sekundi. Zatim ponovo uključite utikač u utičnicu i ponovo uključite TV.
Nema slike	<ul style="list-style-type: none">• Proverite priključke antene na zadnjoj strani televizora da vidite da li je pravilno priključen na TV.• Mogući problemi sa kanalom koji gledate<ul style="list-style-type: none">• Pokušajte sa drugim kanalom.• Podesite kontrast i osvetljenost.• Proverite kontrolu zatvorenih titlova. Neki TEKST režimi bi mogli blokirati ekran.
Dobra slika, ali bez zvuka	<ul style="list-style-type: none">• Povećajte jačinu zvuka pritiskom na taster VOL+ na daljinskom upravljaču ili na tastaturi sa strane televizora.• Pritisnite taster MUTE na daljinskom upravljaču da biste se uverili da je isključen zvuk.
Dobar zvuk, ali loša boja	Podesite kontrast, boju i osvetljenost.
Snežna slika i šum	Proverite konekciju antene.
Horizontalna isprekidana linija	Ovo može biti uzrokovano električnim smetnjama (npr. fen za kosu, obližnja neonska svetla, itd.). Isključite opremu.
Televizor ne reaguje na daljinski upravljač	<ul style="list-style-type: none">• Proverite da li baterije rade. Zamenite ako je potrebno.• Očistite sočivo senzora daljinskog upravljača na TV-u.• I dalje možete da koristite tastaturu na bočnoj strani televizora.
Pikseli (tačke) koji su uvek tamni ili uvek osvetljeni	Vaš TV je precizno proizveden korišćenjem izuzetno visokog nivoa tehnologije. Međutim, ponekad se pikseli možda neće pravilno prikazati. Ove vrste pojava su svojstvene ovoj vrsti proizvoda i ne predstavljaju neispravan proizvod.



FOX[®]

be smart

USER MANUAL

**LED TELEVISION
MODEL:
55WOS626D**

ENG

Thank you for purchasing this device.

FOX LED TVs are known for their excellent technical features, as well as their modern, functional, and elegant design. In addition, we have an efficient and widespread service network that gives our proud users a sense of security. You have made the right choice. Below you will find the user manual. It's not complicated, but you must follow it carefully.

CONTENT

Safety Information

Language

Region

Accessibility Settings

How to Set Up the TV

Internet Connection

Password

Terms and Conditions

User Environment Analysis

Device Installation Type

Channel Setup

Automatic Tuning

Initial Setup

Home Screen

Guide

Search

Settings

Notifications

Account

Settings

All Settings

Accessibility

Connection

Internet

Edit Mode

Operating Mode

All Settings

Picture

Sound

General

Support

Multimedia

Photo

Video

Music

GENERAL SAFETY

Read this manual thoroughly before you start using the TV.

Store this manual, the completed warranty card, your receipt and the product packaging. The safety precautions instructions reduces the risk of fire, electric shock and injury when correctly complied to. Please follow all instructions and take notice of all warnings.



The cover (or back) of the unit should not be removed to prevent risk of electric shock.

This unit must be serviced by a qualified service personnel only.



The lightning flash with symbol within the triangle is intended to warn you of a non-insulated dangerous voltage in the product's enclosure that could be of sufficient magnitude to generate a risk of electric shock to persons.



The exclamation point within the triangle is intended to warn you to the presence of important operating and maintenance instructions in the documents included with the product.

IMPORTANT INFORMATION

- Using Cabinets or stands recommended by the manufacturer of the television.
- Only using furniture that can safely support the Products.
- Ensure the Product is not overhanging the edge of the supporting furniture.
- Do not place the product on a high furniture without securing both the furniture and the product to a stable support.
- Do not place the product on cloth or other conductive materials.
- Warn children of the dangers of climbing on furniture to reach the television or its controls and to call for an adult to assist.

GENERAL SAFETY INSTRUCTIONS

IMPORTANT INFORMATION

- Do not expose this appliance to rain or moisture as it may result in fire or an electric shock hazard
- Do not temper or change or modify the product in any way.
- Only use Accessories outlined and recommended by the manufacturer.
- Please do not expose the product to splashing or water contact
- Please do not place any object on top of the product including objects filled with liquids such as vases.
- Danger of explosion if battery is incorrectly placed. Replace with same or equivalent type.

Installation - Please follow instruction when installing this product in accordance with the instruction manual. This product must be positioned in a sufficiently stable location, it can be potentially hazardous due to falling and can cause injury, particularly to children if it positioned incorrectly.

- Before installing this TV set, make sure your outlet voltage corresponds to the voltage stated on the product rating label
- Do not use a damaged power cord, plug or loose outlet. Doing so may cause an electric shock.
- Do not plug several devices into the same outlet. Doing so may cause the outlet to overheat and start a fire. Make sure the outlet is readily accessible during operation of the equipment.
- Do not bend, twist or kink the power cord excessively.
- Do not allow anything to rest on or roll over the power cord and antenna cable. Doing so may cause a fire or an electric shock.
- Do not run the power cord near heat-producing appliances such as radiators, stoves or irons. The excessive heat could melt the insulation and expose live wires, resulting in fire or electric shock.
- Unplug this TV during lightning storms or when unused for long periods of time. Not doing so may result in fire or electric shock.
- Do not cover the ventilation openings of the product with items such as newspapers, tablecloths, curtains etc or insert objects into the slots available on the products. As this could result in the product temperature rising and could cause a fire.
- If you notice any unusual odors or smoke around the unit, immediately disconnect the unit from the outlet and contact the service center. Failure to do so may result in fire or electric shock.
- When not using the unit for long periods of time or when you are moving the unit please ensure to disconnect the power cord from the wall socket.

GENERAL SAFETY INSTRUCTIONS

- Please beware that Dust could accumulate over time on the unit and cause it to generate heat and or deteriorate insulation, which in turn may result in an electrical fire.
- The product is not intended for use by persons (including children) with reduced physical, sensory or mental capabilities, or young children of any age, They must be supervised product by a person responsible for their safety.
- Batteries from the remote control must be only removed by an adult, the adult must ensure to keep them out of reach of infants and children. Seek medical attention immediately if a child has swallowed a battery.
- Batteries (battery pack or batteries installed) shall not be exposed to excessive heat such as sunshine, fire or the like.
- To maintain the product do not use any chemical or cleaning agent or wet cloth, please only ensure to utilize a dry cloth to wipe it down from marks or dust and only after unplugging the product from the power socket.
- Please ensure to contact our call center for any repair or service required for the products.

WARNING!

It is STRONGLY RECOMMENDED that you ANCHOR this product.

Toppling furniture and TV's can cause serious injury or death.

TO HELP AVOID ANY SERIOUS OR FATAL INJURY, WE STRONGLY RECOMMEND THAT THIS PRODUCT BE PERMANENTLY FIXED TO THE WALL OR OTHER SUITABLE SURFACE. FIXING DEVICES ARE NOT INCLUDED SINCE DIFFERENT SURFACE MATERIALS REQUIRE DIFFERENT ATTACHMENTS. PLEASE SEEK PROFESSIONAL ADVICE IF YOU ARE IN DOUBT WHAT FIXING DEVICE TO USE.

If a television is not positioned in a sufficiently stable location, it can be potentially hazardous due to falling. Many injuries, particularly to children, can be avoided by taking simple precautions such as:

- Using cabinets or stands recommended by the manufacturer of the television.
- Only using furniture that can safely support the television.
- Ensuring the television is not overhanging the edge of the supporting furniture.
- Educating children about the dangers of climbing on furniture to reach the television or its controls.

GENERAL SAFETY INSTRUCTIONS

Please make sure upon positioning this product, the place is:

- Not wet or damp and Well ventilated
- Away from direct sunlight or heaters.
- Away from splashes or food.
- Protected from excessive dust or grease.
- Do not install this equipment in a confined space such as a bookcase or similar unit.
- Do not install the TV set near heat sources such as radiators, stoves or other audio visual equipment that produce heat.
- Do not place containers with liquids, if liquid falls inside the products it may result in short-circuit, fire or electric shock.
- Do not place small metallic objects on top of the unit. Metal object falls inside the product it may result in short-circuit, fire or electric shock.
- The antenna must be installed away from high-voltage power line,
- Do not use or store flammable or combustible materials near the unit. Doing so may result in fire or explosion. Do not place any naked flame sources, such as lit candles, cigarettes or incense sticks on top of the TV set.
- Please contact an antenna professional installer to install the antenna to avoid incorrect installation which could result in fire, electric shock or serious injury.
- Install the unit at a reasonable distance from the wall to ensure sufficient ventilation.
- If mains plug or an appliance coupler is used as the disconnect device, the disconnect device shall remain readily operable.



® The terms HDMI, HDMI High-Definition Multimedia Interface, HDMI Trade dress and the HDMI Logos are trademarks or registered trademarks of HDMI Licensing Administrator, Inc.

INSTALLATION

Install the stand as described below, or if you want to mount it to a wall, please contact a professional installer.

Please ensure the TV is not plugged into the wall socket and furthermore we recommend to get another person to assist in the following task.

Attaching the stand

Step 1

Place a soft cushioned material on top of a flat surface to prevent damaging the screen panel. Then place the TV screen flat on top, with the screen side facing down, as illustrated on the right.

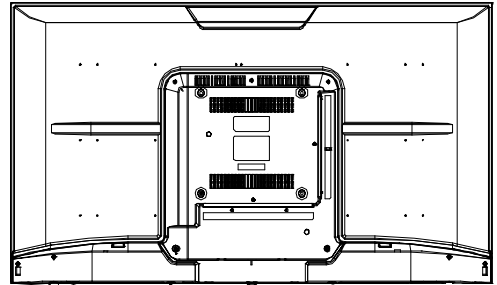

Step 2

Align the stand leg to the installation point, as illustrated below

Step 3

Tighten the screws (supplied) with a screwdriver to affix the stand to the panel, as illustrated on the right.

CAUTION!

Do not apply excessive force as this may damage the screw holes.

INSTALLATION

Wall-Mounting Instructions

Please ensure the TV is not plugged into the wall socket and furthermore we recommend to get another person to assist in the following task.

We recommend you use a professional installer as we assume no liability for any eventual damage to the product or injury to yourself if you mount the TV on your own.

BACK OF TV 55inch
VESA PATTERN: 200 x 200mm

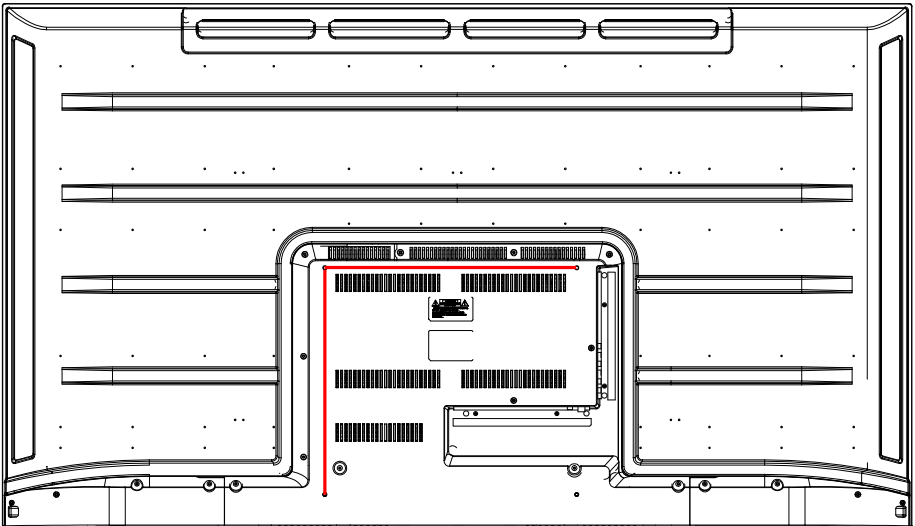

NOTE: If you are wall-mounting the TV, this should be done by a qualified installer.

CONTROLS AND CONNECTIONS

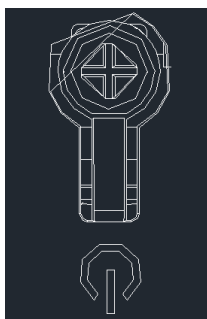
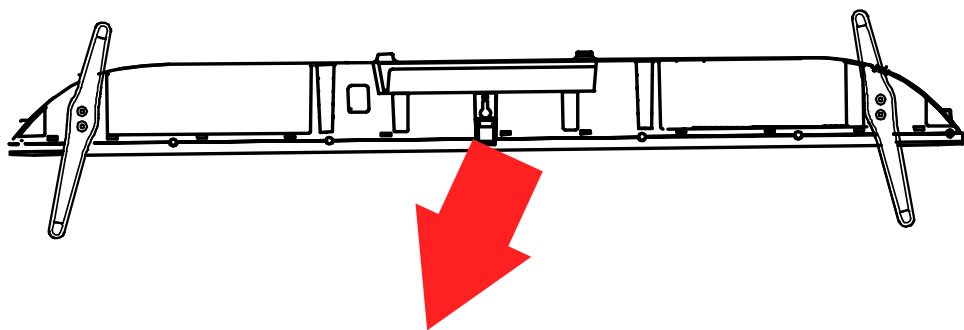

CONTROLS AND CONNECTIONS

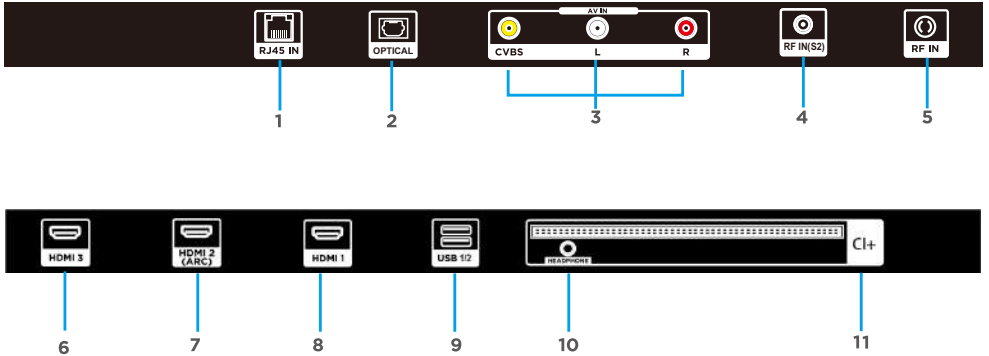

1. RJ45 (ETHERNET) OPTICAL
2. OUT
3. CVBS/ AUDIO LEFT & RIGHT RF
4. IN (SATELLITE)
5. RF IN (ANTENNA)
6. HDMI 3
7. HDMI 2 (ARC)
8. HDMI 1
9. USB INPUT*2
10. HEADPHONE OUT
11. CI+

USB connection

Insert a USB storage device into the USB port to record, playback of video/ photo/music

MAGIC REMOTE CONTROL



Next few pages of MAGIC REMOTE CONTROL explains the following:

- First Time Pairing
- Re-Registering The Magic Remote Control

MAGIC REMOTE CONTROL

Please follow instruction when pairing magic mouse remote control for your webOS TV.

Your Smart TV works with a Magic Remote Control that acts as both a cursor and a remote control and a Screen Remote that allows you to operate your Smart TV and the external devices connected to your Smart TV.

You can use the Magic Remote Control like a mouse to select and run content on your Smart TV. The Magic Remote Control also supports voice commands (ThinQ AI) and gestures to allow you convenient access to various Smart TV functions.

FIRST TIME PAIRING



Registering the Magic Mouse Remote Control



You must register the Magic Remote Control on your Smart TV when you use it for the first time. To register your Magic Remote Control using the **Wheel (OK)** button, perform the following steps:

1. Turn on your Smart TV.
2. Wait for 10 seconds while your Smart TV turns on.
3. Aim the Magic Remote Control at the Smart TV, and then press the **Wheel (OK)** button. A message appears after the Magic Remote Control is registered.
 - If the Magic Remote Control does not register, turn your Smart TV off and on again and repeat the registration process.

MAGIC REMOTE CONTROL (cont.)

RE-REGISTERING THE MAGIC REMOTE CONTROL

If the Magic Remote Control is not functioning properly, initialize it and then re-register it. To use the **Smart Home** () button and **BACK** () button on the Magic Remote Control to re-register the Magic Remote Control, perform the following steps:

1. Hold down the **Smart Home** () button and **BACK** () button on the Magic Remote Control for 5 seconds to initialize the Magic Remote Control.
2. Aim the Magic Remote Control at your Smart TV, and then press the **Wheel (OK)** button. A message appears after the Magic Remote Control is registered.

Note: Aim the Magic Remote Control at your Smart TV, and then hold down the **BACK** () button for 5 seconds to re-register the Magic Remote Control.

MAGIC REMOTE CONTROL

Using the Remote Control

- Battery should normally last for about one year.
- Do not mix old and new batteries in the remote
- Do not use different types of battery
- If you do not intend to use the unit for a long time, please remove batteries from the remote to avoid accident.
- Keep batteries away from children and pets.
- Never throw batteries into a fire.
- Do not drop, or impact the remote control as it void warranty immediately.
- The remote control operate at a range of 5 to 6M effectively
- Do not expose the remote control sensor to a bright light.

OPENING REMOTE BATTERY COMPARTMENT TO REPLACE BATTERIES

1. Turn the remote control over to its back.
2. Press and slide the battery compartment to open the cover.
3. Place 2x AA batteries (provided) into the battery compartment and be sure to match the polarities (+/-) marked on battery compartment.
4. Close and shut the battery compartment. Make sure it clicks when completely closing it.

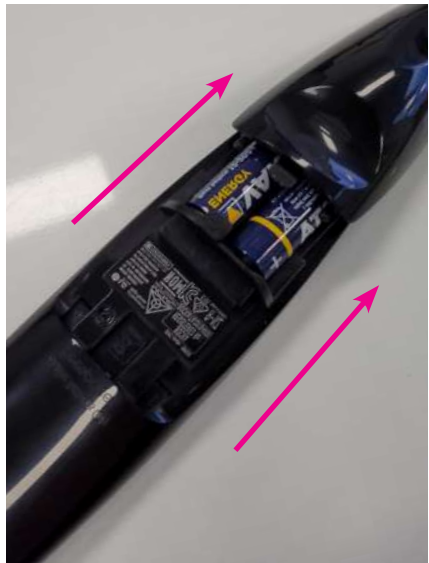

HOME PAGE



Language

Select the language you prefer.

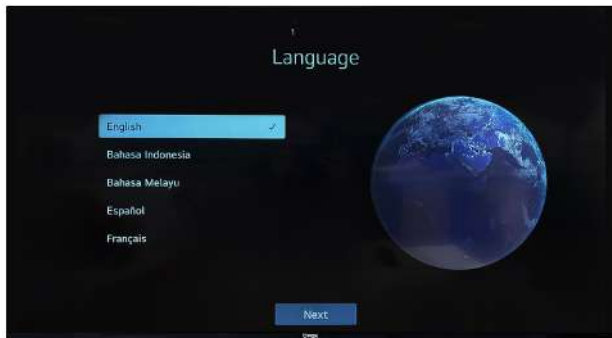

Region

Select the region (country) you are located in.

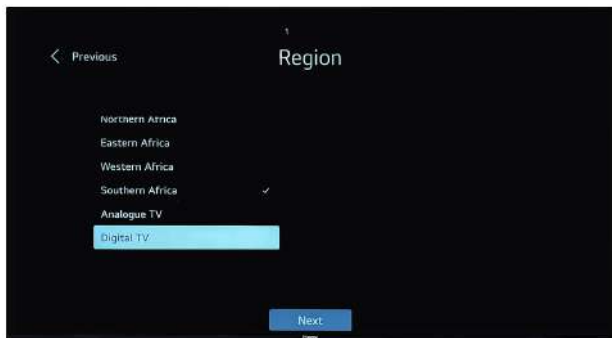

Accessibility Settings

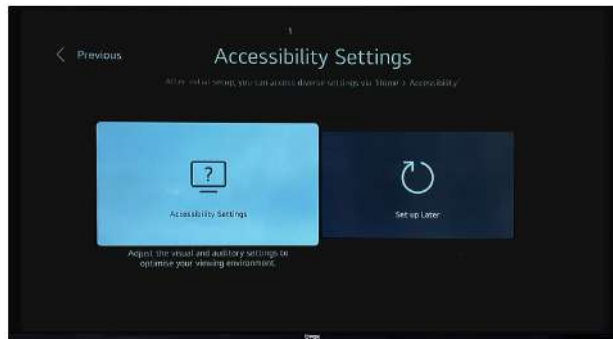

How to Set Up the TV

Select the field using the remote control.



Internet Connection

Connect your device to a Wi-Fi network or via cable.



Password

Enter the correct Wi-Fi password.

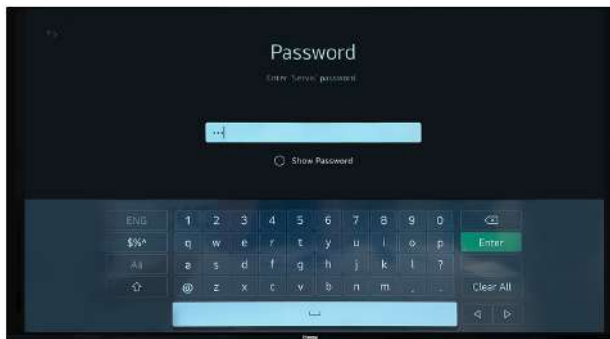

Terms and Conditions

To use Smart TV services and features, you must accept the Terms and Conditions.



User Environment Analysis

Automatic check.



User Environment Analysis

Select your viewing method.

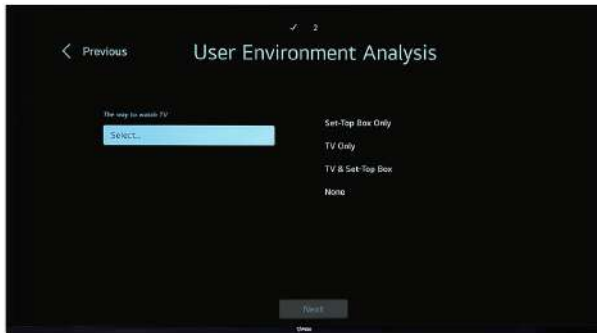

Device Installation Type

Select the setup method for your device.



Always ready

Set the Always Ready mode and enjoy a special experience even when you turn off the TV.

You can control the TV using voice commands in Always Ready mode.



Sign In



HOME

When finish First Time setup,you can enter HOME screen.

(Option:Guide/Search/Settings/Notifications/Account)

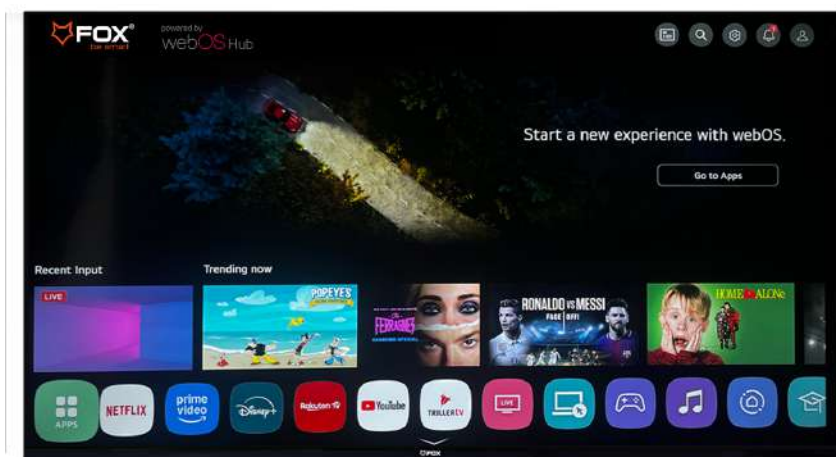

Guide

Press **[▼]** / **[▲]** / **[◀]** / **[▶]** button to  ,Press **[OK]** button to enter.
select (Option:Guide/Programmes/TV)

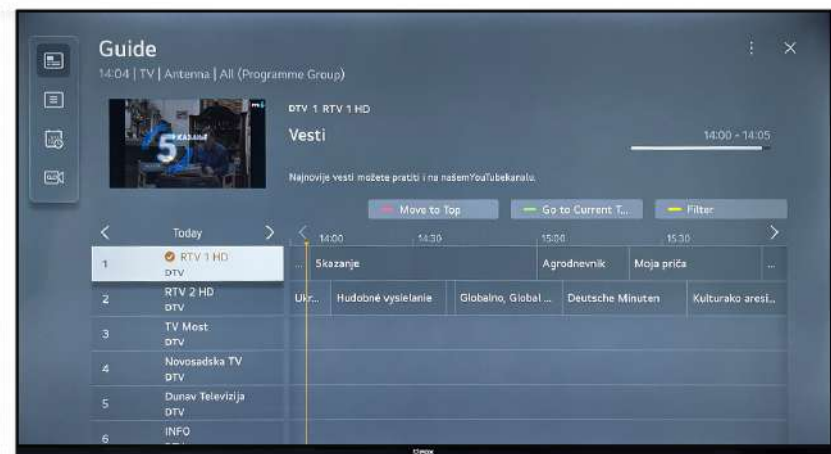

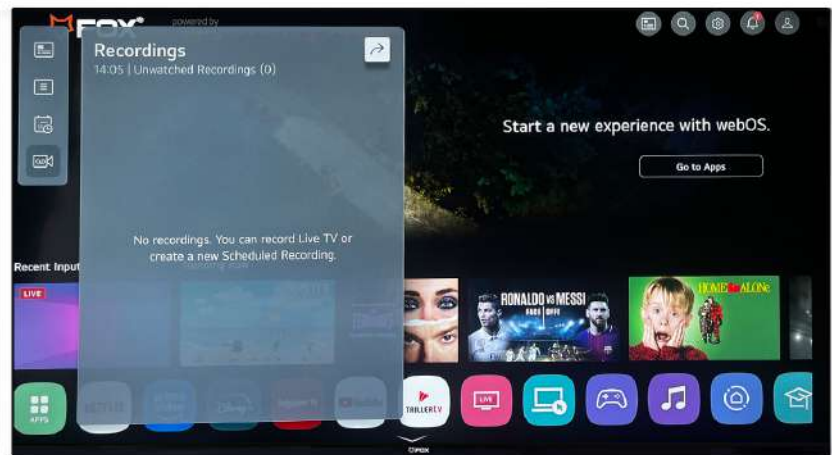
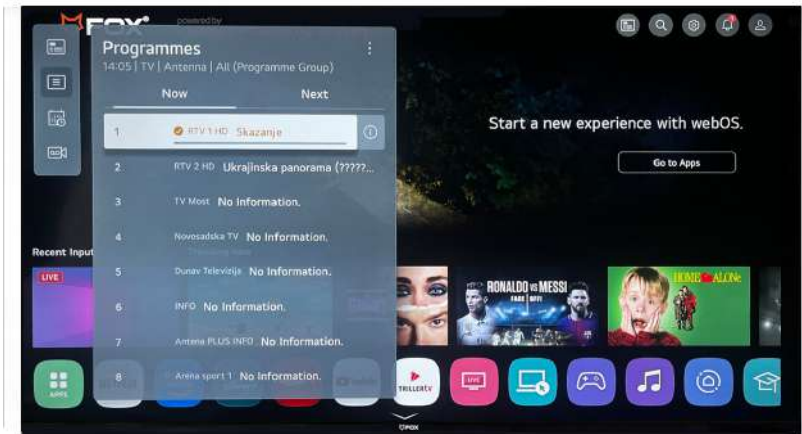

Settings

Press [▼] / [▲] / [◀] / [▶] button to select , Press [OK] button to enter.

(Option: All Setting/Accessibility/Internet/Edit Mode/Recent History/

Picture Mode/

Panel Brightness/Sound Mode/Sound Out/Sleep Timer/Eye Care Mode/Screen Off/

Game Optimiser)



All Setting

Press [▼] / [▲] / [◀] / [▶] button to select , Press [OK] button to enter.

(Option: Picture/Sound/General/Support)

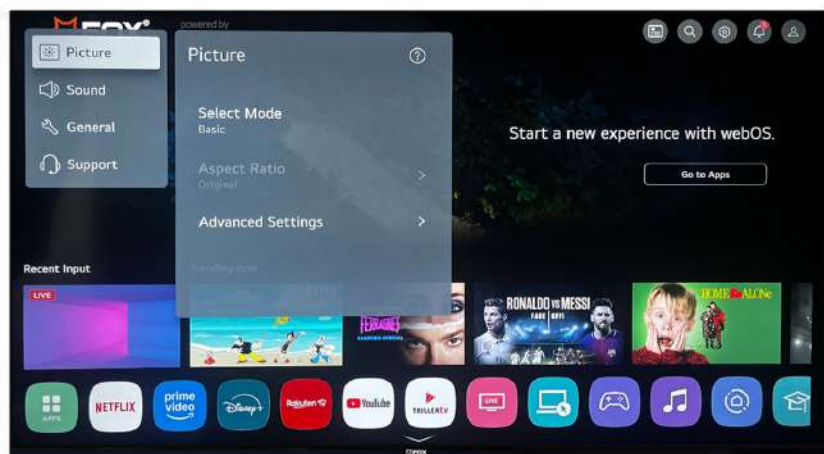

Picture

Press **【▼】 / 【▲】** button to select Picture, and press **【OK】** bottom or **【▶】** bottom to enter.

(Option: Select Mode/Aspect Ratio/Advanced Settings)

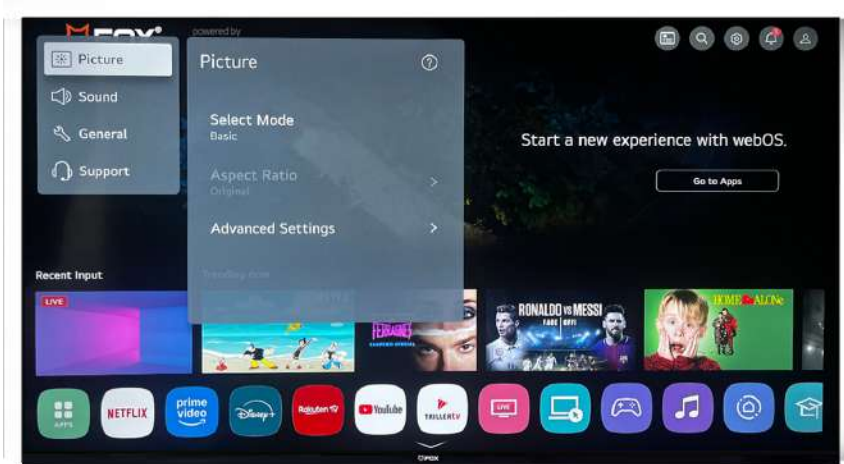

Select Mode

Select the appropriate picture mode according to the viewing environment or content type.

Press **【▼】 / 【▲】** button to select Select Mode, and press **【OK】** bottom to enter.

(Option: Vivid/Standard/Basic/Cinema/Sports/FILMMAKER MODE)

- Vivid Sharpens the image by increasing the contrast, brightness and sharpness.
- Standard This mode to make users experience high-quality images under normal light.
- Basic Provide the most basic and universal display effect.
- Cinema This mode is more suitable for watching movies.
- Sports This mode is more suitable for watching sport video.
- FILMMAKER Keeping with the filmmakers' intentions in TV, it respects frame rate, aspect ratio, color, and contrast, while also turning off noise reduction and sharpening
- MODE

Sound

Press **【▼】** / **【▲】** button to select Sound, and press **【OK】** or **【▶】** to enter.
(Option: Select Mode/Sound Out/Advanced Settings)

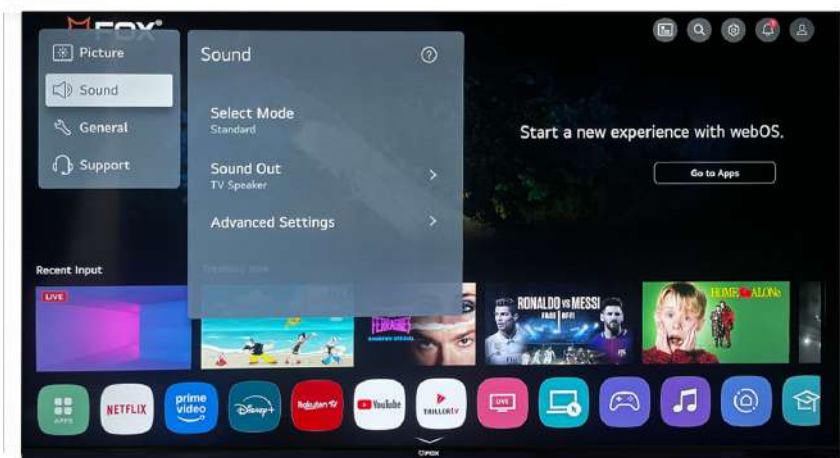

Select Mode

You can select the best sound mode for any type of content you are trying to watch.

Press **【▼】** / **【▲】** button to select Select Mode, and press **【OK】** button to enter.
(Option: Standard/Cinema/Clear Voice/Sports/Music)

- | | |
|-------------|---|
| Standard | A balanced sound in any environment |
| Cinema | Adds in more bass and treble to give a much bolder sound. |
| Clear Voice | Increase the volume of the human voice, and reduce the background music, environmental sounds |
| Sports | Increase the volume of the human voice, enhance the volume of cheers and ambient sounds. |
| Music | balance of levels, adding bass and treble as it is optimized for music. |

General

Press [▼] / [▲] button to select General, and press [OK] or [▶] to enter.
(Option: Accessibility/Always Ready/AI Service/Game Optimiser/Usage Care/Programmes/Network/External Devices/System/Energy Saving)



Accessibility

Press [▼] / [▲] button to select Accessibility, and press [OK] bottom to enter.
(Option: Audio Guidance/Audio Description/Audio Description Volume/Learn Remote Control/Extend Pressing Time on Remote/Device Power Sound/Screen Zoom/Listen simultaneously with a hearing aid/Hard of Hearing/Subtitles/Text with High Contrast/Focus with High Contrast/Greyscale/Invert Colours)

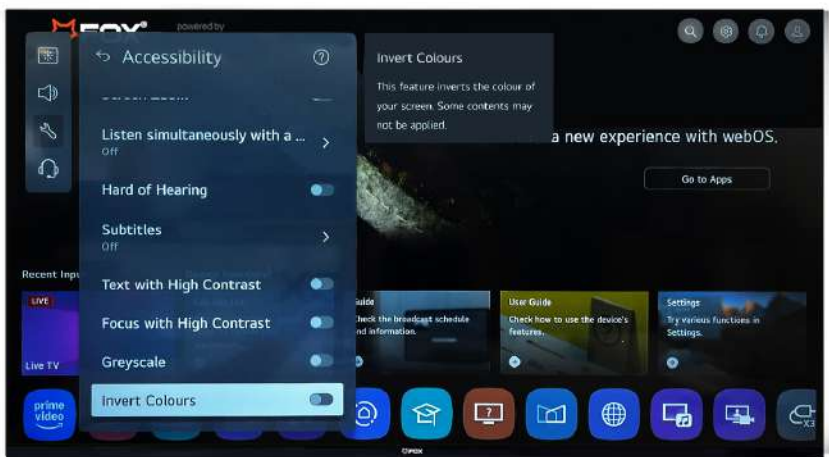

Audio Guidance

This feature describes menu names or device statuses via audio. Turn on this feature to navigate with only the directional buttons on remote.

Press [▼] / [▲] button to select Audio Guidance, and press [OK] bottom to enter.

(Option: Enable the function/Speed/Volume/Pitch/High-quality language pack) Enable the function

Press [▼] / [▲] button to select Enable the function, and press [OK] bottom to adjust off or on.

Programmes

Set up and manage settings related broadcast programmes.

Press [OK] bottom to enter.

(Option: Programme Tuning & Settings/Programme Manager/
Dual Mono/CI Information/Copy Programmes/HbbTV)

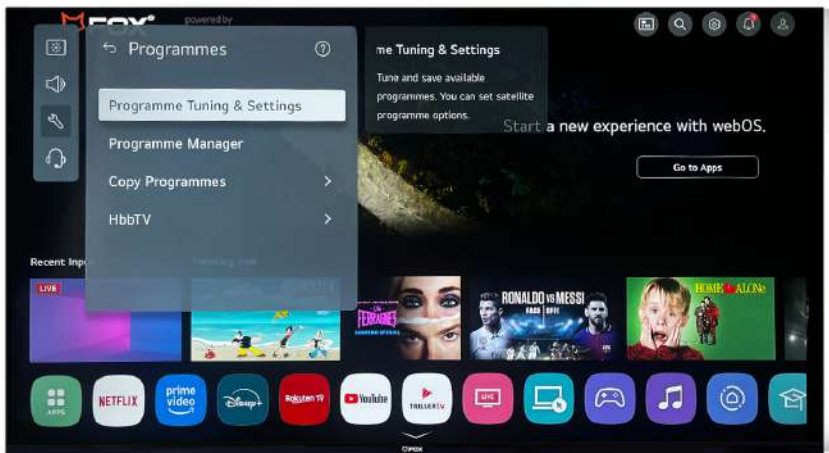

Programme Tuning & Settings

Tune and save available programmes. You can set satellite programme options. Press [OK] bottom to enter.

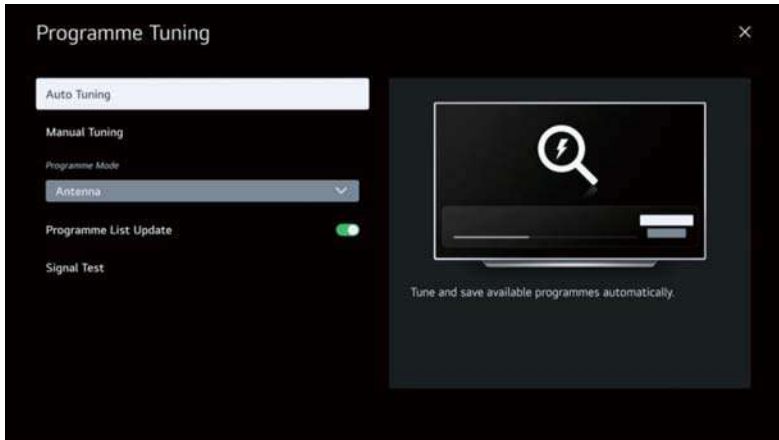

Programme Mode

Select programme mode from antenna, cable, satellite and others.

Press **【OK】** bottom to select.

(Option:Antenna/Cable/Satellite)

Antenna Auto Tuning

Tune and save available programmes
automatically

Press **【OK】** bottom to enter programme tuning mode, Press **【▼】** / **【▲】** button to select antenna, and Press **【◀】** / **【▶】** button to choose Next and Press **【OK】** bottom to enter the next step.

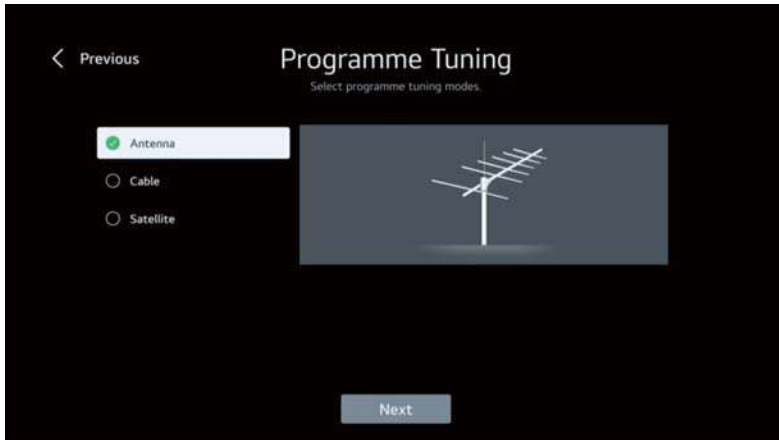

Press **【▼】 / 【▲】** button to select tuning options, and
Press **【◀】 / 【▶】** button to choose Next and Press **【OK】** button to tuning.
(Option: Digital Only Search/Smart Retuning)

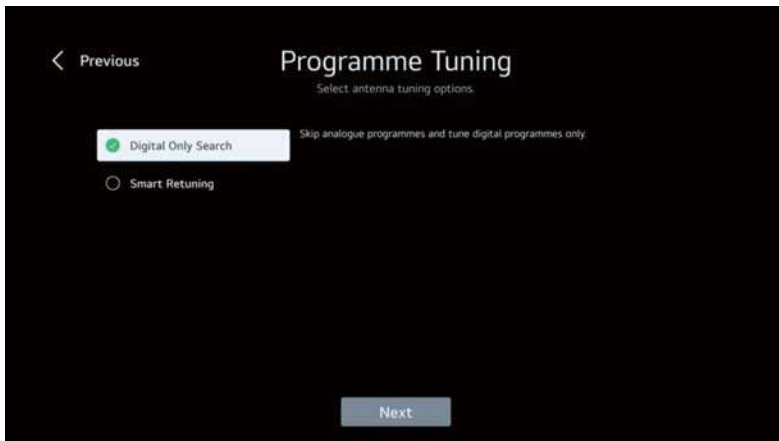



Antenna Manual Tuning

Tune and save programmes manually.

Press **【OK】** bottom to enter programme tuning type, Press **【▼】** / **【▲】** button to select tuning type, Press **【OK】** bottom to enter the next step.

(Option: Antenna DTV/Antenna TV)

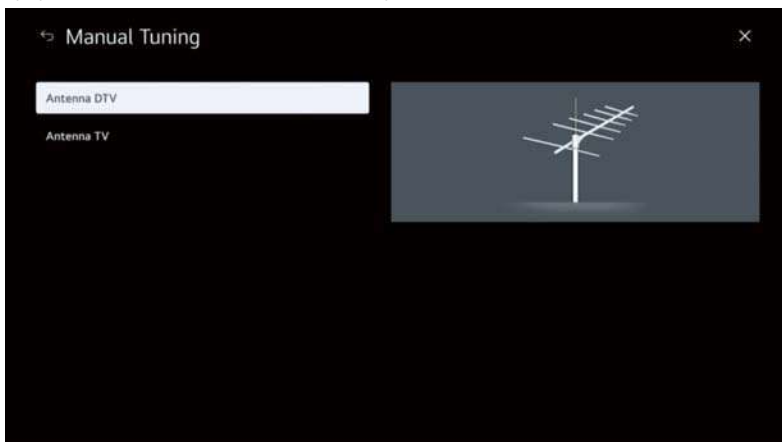

Antenna DTV

Press **【▼】** / **【▲】** button to select tuning options, and Press **【▼】** / **【▲】** button to choose update and Press **【OK】** bottom to tuning.

(Option: UHF CH/Frequency(kHz)/Bandwidth(MHz))

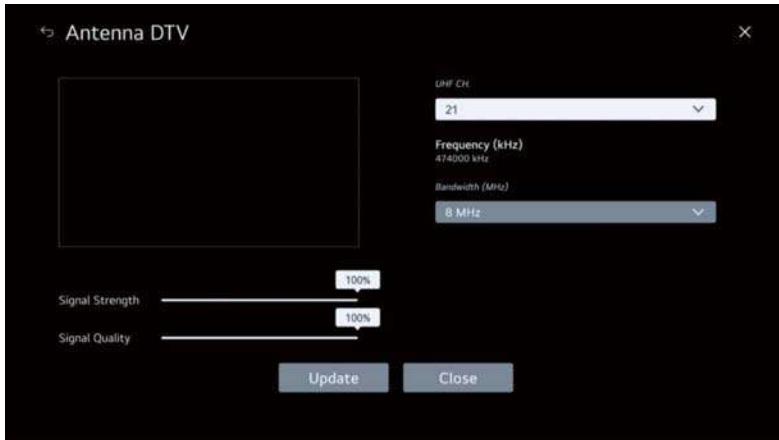

Antenna TV

Press **▼** / **▲** button to select tuning options, and Press **▼** / **▲** button to choose search up/search down and Press **OK** button to tuning.

(Option: Storage/System/Band/Programme/Name)



Cable Auto Tuning

Tune and save available programmes automatically

Press **OK** button to enter programme tuning mode, Press **▼** / **▲** button to select Cable, and Press **◀** / **▶** button to choose Next and Press **OK** button to enter the next step.



Press **【◀】 / 【▶】** button to select cable settings, and Press **【▼】 / 【▲】** button to choose Next and Press **【OK】** button to enter the next step.
(Option: Quick Search/Network Search/Full Search)

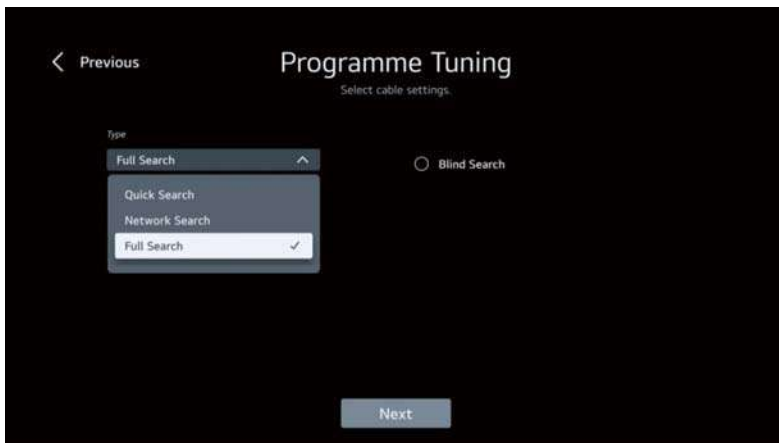

Press **【▼】 / 【▲】** button to select tuning options, and Press **【◀】 / 【▶】** button to choose Next and Press **【OK】** button to tuning.
(Option: Digital Only Search/Skip Scramble Programmes)



Cable Manual Tuning

Tune and save programmes manually.

Press **[OK]** bottom to enter programme tuning type, Press **[▼]** / **[▲]** button to select tuning type, Press **[OK]** bottom to enter the next step.

(Option: Cable DTV/Cable TV)



Cable DTV

Press **【▼】** / **【▲】** button to select tuning options, and Press **【▼】** / **【▲】** button to choose update and Press **【OK】** button to tuning.

(Option: Frequency (kHz)/Symbol Rate (kS/s)/Modulation)

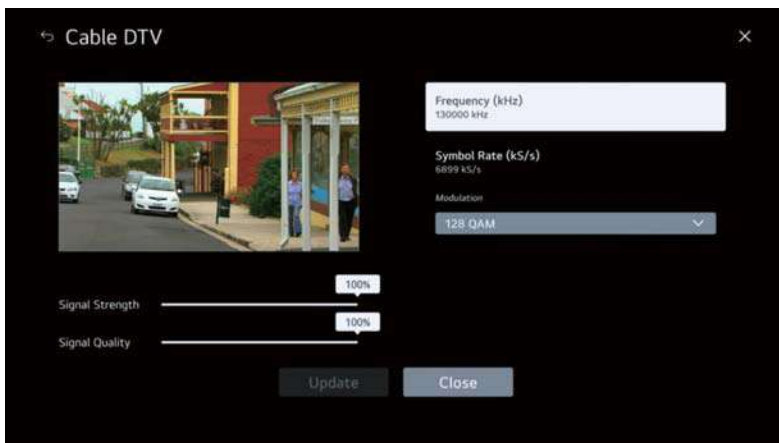

Cable TV

Press **【▼】** / **【▲】** button to select tuning options, and Press **【▼】** / **【▲】** button to choose search up/search down and Press **【OK】** button to tuning.

(Option: Storage/System/Band/Programme/Name)



Satellite Auto Tuning

Tune and save available programmes
automatically

Press [OK] bottom to enter programme tuning mode, Press [v] / [^] button to select Satellite, and Press [◀] / [▶] button to choose Next and Press [OK] bottom to enter the next step.

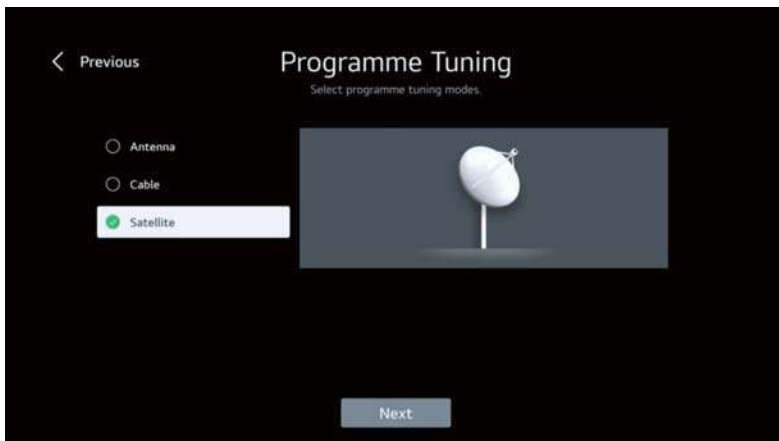

Press [v] / [^] button to select satellite service operator, and Press [◀] / [▶] button to choose Next and Press [OK] bottom to tuning.

(Option: Freesat/Other Operators)

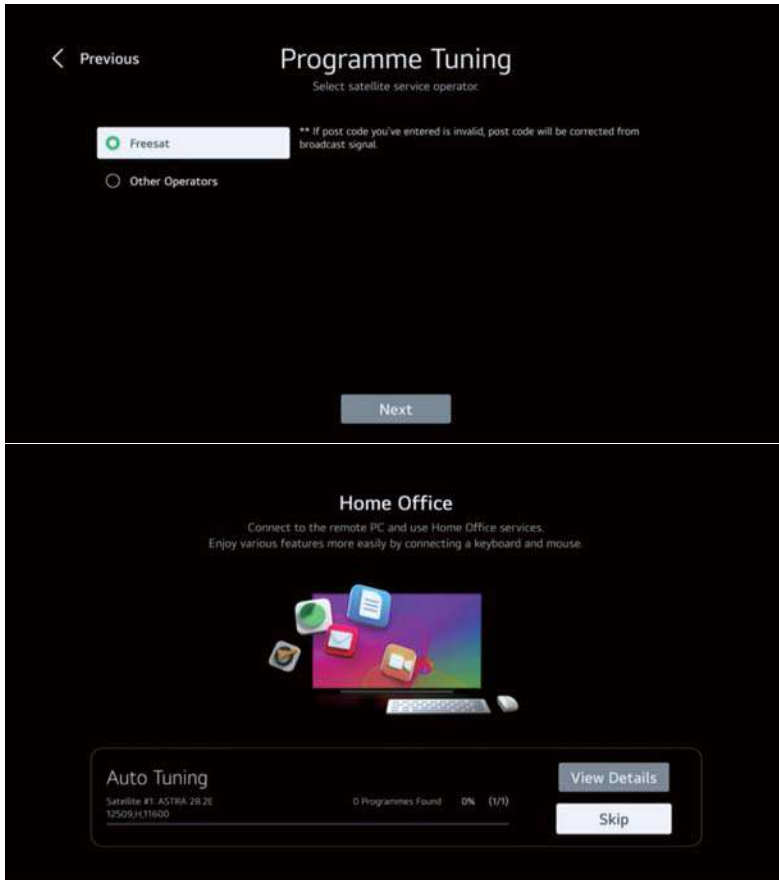

Satellite Settings

Adjust Satellite Settings.

Press **[OK]** bottom to enter Satellite Settings, Press **[OK]** button to edit Satellite.

(Option: Satellite/LNB Frequency/Transponder/22kHz Tone/LNB Power/DiSEqC/Unicable/Unicable Settings/Motor Type/Motor Settings)

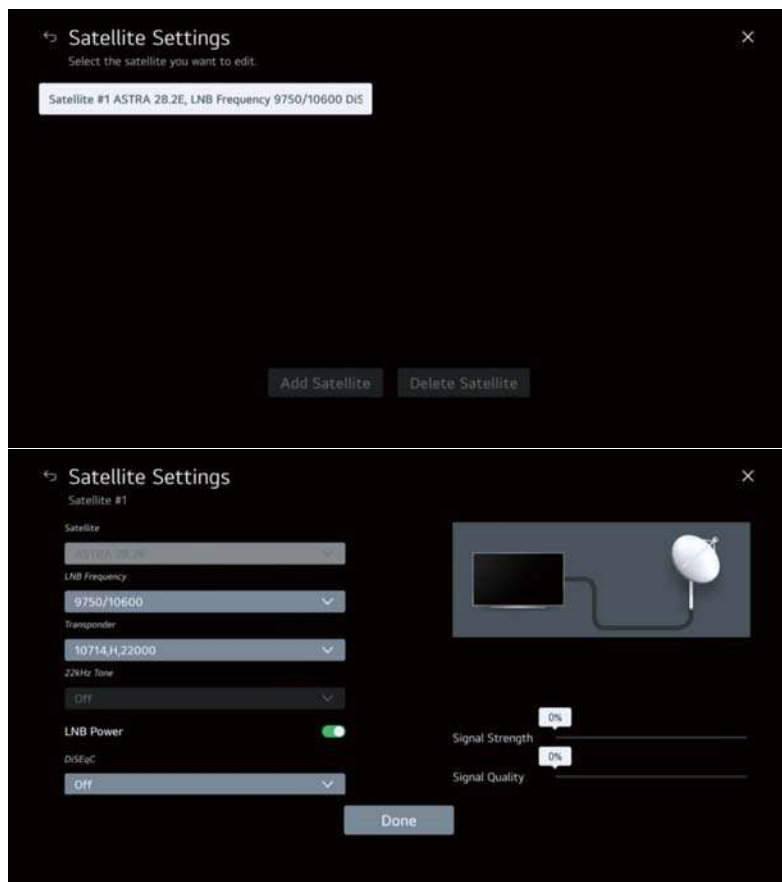

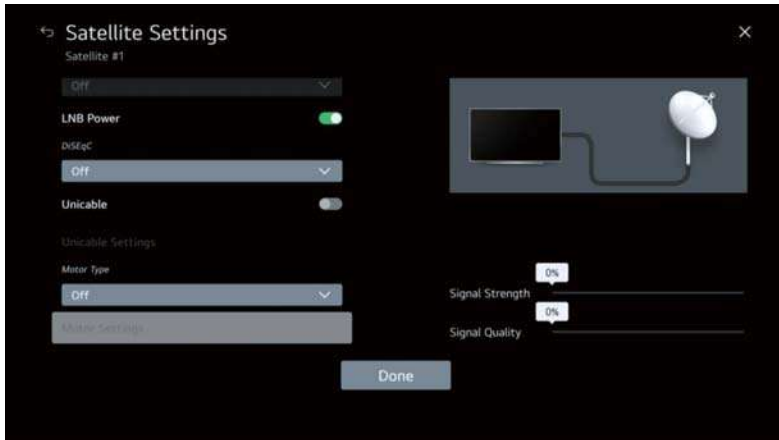

Programme Manager

Manage programmes stored on the TV

Press **【▼】 / 【▲】** button to select Programme Manager, and Press **【OK】** button to enter.

(Option: Edit All Programmes / Edit Favourites / Lock / Unlock / Skip / Restore)

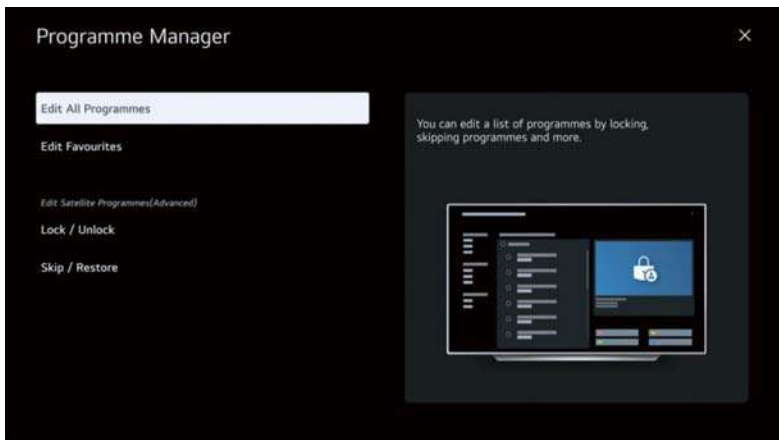

Dual Mono

You can select left and right audio settings for broadcast signal.

Press **【▼】 / 【▲】** button to select Dual Mono, and Press **【OK】** button to enter. (Option: L+L/R+R/L+R)

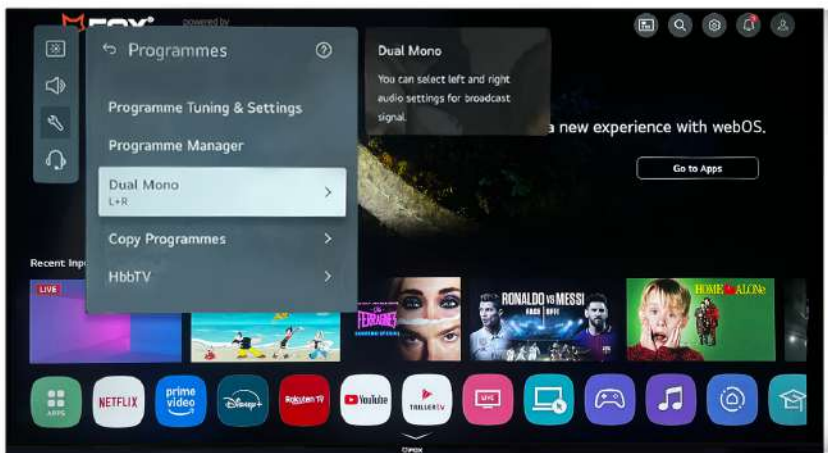

CI Information

View current Common Interface (CI) information.

Press **▼** / **▲** button to select CI Information, and Press **OK** button to enter.

Copy Programmes

Import/export your TV's programme list information from/to a connected USB device.

Press **▼** / **▲** button to select Copy Programmes, Press **OK** button to enter. (Option: USB storage for Copy Program/TV to USB/USB to TV)

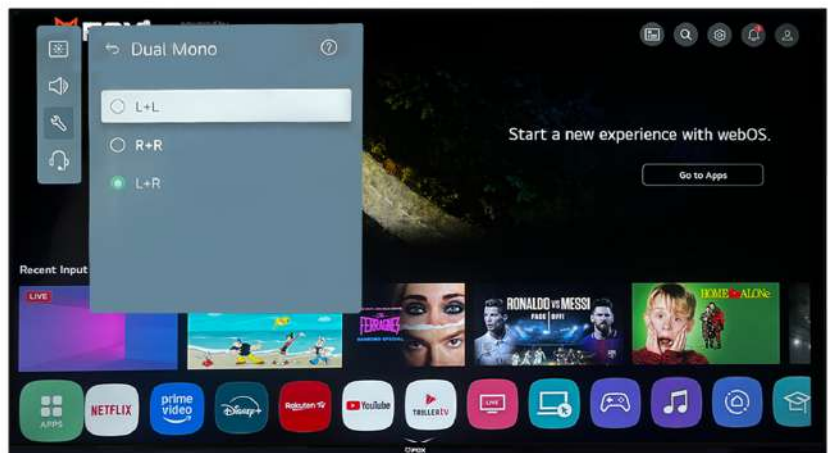



HbbTV

The service provides additional information and relevant content on the programmes being watched.

Press **【▼】** / **【▲】** button to select HbbTV, Press **【OK】** button to enter.

(Option: Auto Start/Do Not Track/Provide HbbTV Distinctive ID/Reset HbbTV Distinctive ID/Delete Connection History/Multi Programme **Audio/Third-Party Cookies**)

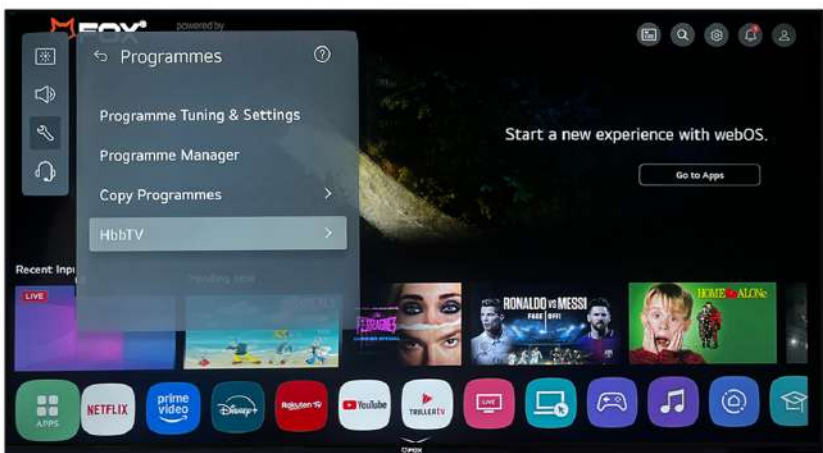

set settings related to your wire /wireless network. Press **【OK】** button to enter.

Media

Connect a USB storage device to the USB port on the TV to enjoy the content files stored on the USB storage device on your TV.

Press **【▼】 / 【▲】** button on to select

type.(Option:All/Photo & Video/Photo/
Video/Music)



Photo

Press **【▼】 / 【▲】 / 【◀】 / 【▶】** bottom to select photo, Press **【OK】** button to play.

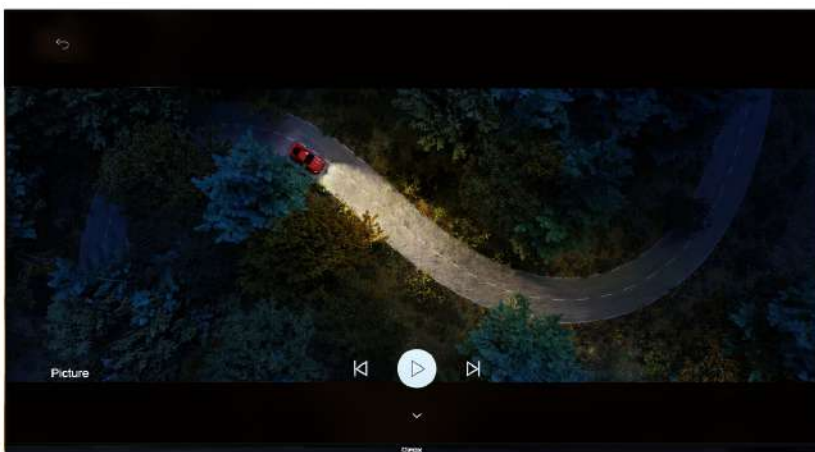

Press **【▼】** bottom to select , Press **【OK】** button to enter.

(Option: Rotate/Zoom in/360°VR play/Background music/
Options)



Video

Press **【▼】** / **【▲】** / **【◀】** / **【▶】** bottom to select Video, Press **【OK】** button to play.

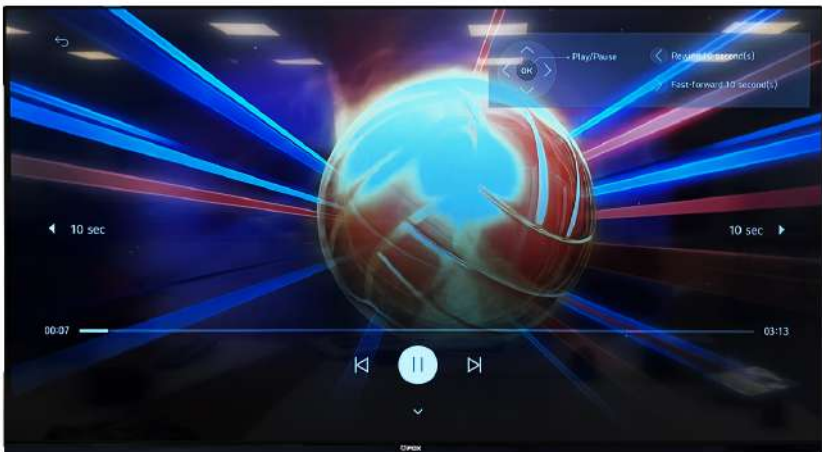

Press **【▼】** bottom to select , Press **【OK】** button to enter.
 (Option: Subtitle/Rotate/Rewind/Repeat All/Fast Forward/360°VR play/Options)

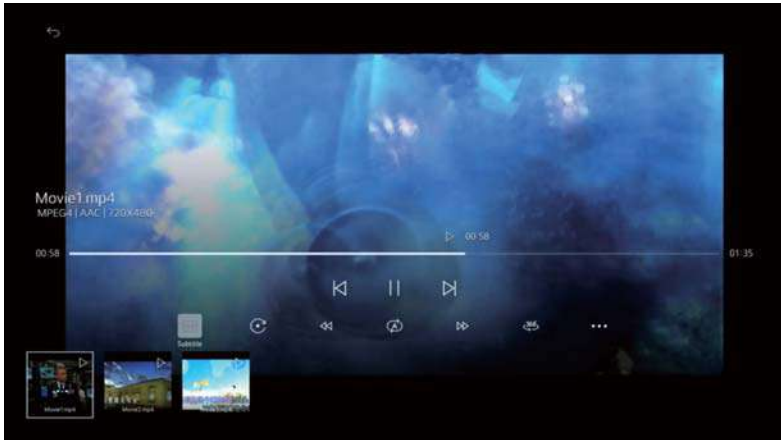

Music

Press **▼** / **▲** / **◀** / **▶** bottom to select Music, Press **OK** button to play.

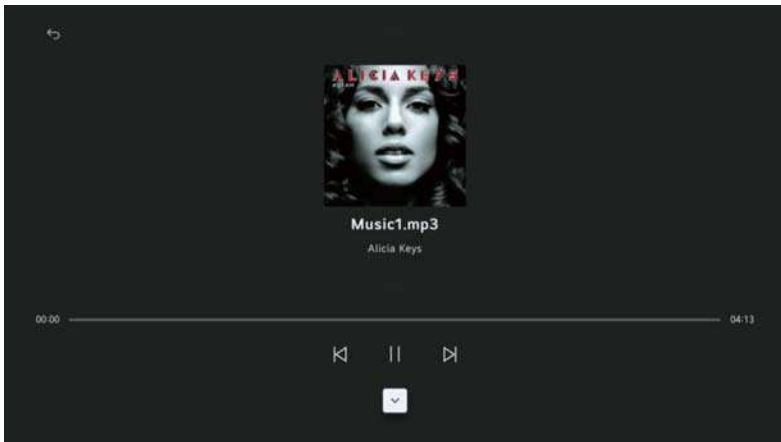

Press **▼** bottom to select , Press **OK** button to enter. (Option: Shuffle/No Repeat/Lyrics/Screen Off)

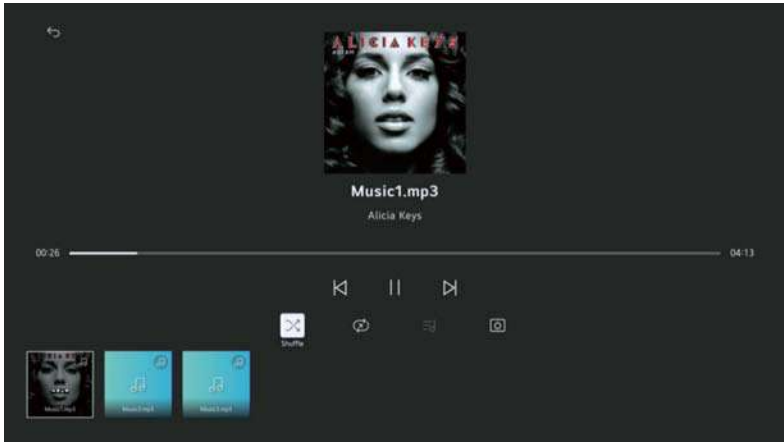

FAQs

PROBLEMS ABOUT TV SET

Symptoms	Items to check and actions to follow
"ghost" or double image	This may be caused by obstruction to antenna due to high rise buildings or hills. Using a highly directional antenna may improve the picture.
No power	<ul style="list-style-type: none">• Check if the TV's AC power cord is plugged into the outlet.• Unplug the TV, wait for 60 seconds. Then reinsert plug into the outlet and turn on the TV again.
No picture	<ul style="list-style-type: none">• Check antenna connections at the rear of the TV to see if it is properly connected to the TV.• Possible broadcast station trouble. Try another channel.• Adjust the contrast and brightness setting.• Check the Closed Captions control. Some TEXT modes could block the screen.
Good picture but no sound	<ul style="list-style-type: none">• Increase the volume level by pressing the VOL+ button on the remote control or on the TV side control panel.• Press the MUTE button on the remote control to ensure mute is off.
Good sound but poor color	Adjust the contrast, color and brightness settings
Snowy picture and noise	Check the antenna connection
Horizontal dotted line	This may be caused by electrical interference (e.g. hair dryer, near-by neon lights, etc.) Turn off the equipment.
Television not responding to remote control	<ul style="list-style-type: none">• Check whether the batteries are working. Replace if necessary.• Clean the remote control sensor lens on the TV.• You can still use the buttons on the side of your TV.
Pixels (dots) that are always dark or always lit	Your TV is precision-manufactured using an extremely high level of technology. However, sometimes pixels may not display correctly. These types of occurrences are inherent to this type of product and do not constitute a defective product.

PROIZVOĐAČ: VIEW ELECTRONIC CO., LTD
East Industrial Zone, Jiuhua, Nantong, China
UVOZNIK ZA SRBIJU:VIMPORT DOO BEOGRAD,
BATAJNIČKI DRUM 9 DEO 10A,
11080 BEOGRAD- ZEMUN, SRBIJA
UVOZNIK ZA KOSOVO*: P.C. COMP SH.P.K.
ALI VITIA NR.225, 10000 PRIŠTINA

UVOZNIK ZA BIH: FIS DOO,
POSLOVNI CENTAR 96, 72250, VITEZ, BIH
UVOZNIK ZA CRNU GORU: FOX MI DOO,
BRANKA DELETIĆA BB UL-E ST. 26,
81000 PODGORICA, CRNA GORA

UVOZNIK ZA SEVERNУ MAKEDONIЈU: РИМЕКО ДОО
ПЕРО НАКОВ 116, 1000 СКОПЈЕ, СЕВЕРНА МАКЕДОНИЈА

UVOZNIK ZA ALBANIЈU:
GLOBE SHOPS SHPK, RRUGA E KAVAJES,
PALLATI GLOBE, NDERTESA 124, HYRJA 10, 1023,
TIRANA, ALBANIЈA

	LED TV UREDAJ MODEL:55WOS626D
NAPAJANJE: 100-240V~ 50/60 Hz SNAGA POTROŠNJE: 108W	  
UPOZORENJE: KAKO BISTE SPREČILI POŽAR ILI ELEKTRIČNI UDAR NE IZLAŽITE OVAJ UREDAJ KIŠI ILI VLAZI. NE POSTAVLJATE PREDMETE ISPUJENE TEČNOŠĆU NA I OKO UREDAJA. KABL ZA NAPAJANJE ISKLJUČITE IZ UTIČNICE AKO UREDAJ NE KORISTITE DUŽI VREMENSKI PERIOD. OVAJ UREDAJ PRI RADU KORISTI VISOKI NAPON. NE UKLANJAJTE ZADNJI POKLOPAC. OBRATITE SE KVALIFIKOVANOJ SERVISNOJ SLUŽBI ZA OBAVLJANJE SERVISA.	
PROIZVOĐAČ: VIEW ELECTRONIC CO., LTD East Industrial Zone, Jiuhua, Nantong, China.	UVOZNIK ZA SRBIJU: VIMPORT DOO, BATAJNIČKI DRUM 9deo 10a, 11080 BEOGRAD- ZEMUN, SRBIJA
	SERVISKI BROJ: 
	   # 002 20

Nadamo se da ste pažljivo pročitali uputstva i da ćete ih se pridržavati. Za više informacija o FOX uređajima posetite našu internet stranicu:

www.foxelectronics.rs