



UPUTSTVO ZA UPOTREBU

LED TELEVIZORI

Model: 32DTV231E

Hvala Vam što ste kupili ovaj uređaj.

FOX LED televizori prepoznaju se po odličnim tehničkim karakteristikama, kao i modernom, funkcionalnom i elegantnom dizajnu. Osim toga konstantna unapređenja u vidu postprodajne

podrške, izuzetno efikasna i rasprostranjena servisna mreža čine da se ponosni vlasnici **FOX televizora** mogu osećati sigurno.

Napravili ste pravi izbor.

U nastavku slede uputstva za upotrebu. Nisu komplikovana, ali ih se morate pridržavati.

SR

Informacije o proizvodu (lista sa podacima)



Informacije	Vrednost	Jedinica
1. Ime ili zaštitni znak isporučioća	VIMPORT DOO BEOGRAD	
Adresa isporučioća	Batajnički drum 9 deo 10a, Beograd(Zemun)	
2. Identifikaciona oznaka modela	32DTV231E	
3. Klasa energetske efikasnosti za SDR mod	F	
4. Snaga u uključenom stanju za standardni dinamički raspon (SDR)	27.0	W
5. Klasa energetske efikasnosti (HDR)		
6. Snaga u uključenom stanju za mod velikog dinamičkog raspona (HDR), ako je primenljivo		W
7. Snaga u isključenom stanju, ako je primenljivo	0.0	W
8. Snaga u stanju pripravnosti, ako je primenljivo	0.5	W
9. Snaga u umrežanom stanju pripravnosti, ako je primenljivo		W
10. Kategorija elektronskog ekrana	Televizor	
11. Odnos veličina	16 : 9	
12. Rezolucija ekrana (u pikselima)	1366 x 768	piksela
13. Dijagonala ekrana	31.5	inča
14. Dijagonala ekrana	80.0	cm
15. Vidljivo područje ekrana	27.4	dm ²
16. Tehnologija panela koja se koristi	LCD sa LED	
17. Automatska regulacija sjajnosti (ABC) koja je dostupna	Ne	
18. Senzor za prepoznavanje glasa koji je dostupan	Ne	
19. Senzor prisutnosti u prostoriji koji je dostupan	Ne	
20. Učestalost osvežavanja slike (zadata postavka)	60	Hz
21. Minimalna garantovana raspoloživost ažuriranja softvera i integrisanog softvera uređaja, ako je propisana, od datuma završetka stavljanja na tržište do	3	godina
22. Minimalna garantovana raspoloživost rezervnih delova, ako je propisana, od datuma završetka stavljanja na tržište do	3	godina
23. Minimalno trajanje opšte garancije koju daje isporučilac	3	godina
24. Vrsta napajanja:	Unutrašnje	
25. Spoljašnje napajanje (priloženo uz proizvod, nije standardizovano)		
i.		
ii.	Ulazni napon	V
iii.	Izlazni napon	V
26. Spoljašnje standardizovano napajanje (ako nije priloženo uz proizvod, drugo odgovarajuće napajanje)		
i.	Podržani standardni naziv ili popis	
ii.	Potreban izlazni napon	V
iii.	Potrebna jačina struje (minimalna)	A
iv.	Potrebna frekvencija struje	Hz

Tehničke karakteristike : napajanje 100-240 Vac 50/60Hz
snaga potrošnje : 60 W

VAŽNA BEZBEDONOSNA UPUTSTVA

UPOZORENJE

KAKO BISTE SPREČILI POŽAR ILI ELEKTRIČNI UDAR NEMOJTE KORISTITI PRODUŽNI KABL, DUPLI UTIKAČ ILI DRUGE DODATKE NA UTIČNICI OSIM ONIH KOJI BI MOGLI DA SPREČE IZAZIVANJE STRUJNOG UDARA. KAKO BISTE SPREČILI POŽAR ILI ELEKTRIČNI UDAR NE IZLAŽITE OVAJ UREĐAJ VLAZI ILI KIŠI.

 <p>Ovaj simbol munje u jednakostraničnom trouglu upozorava korisnike na prisustvo opasnog i ne izolovanog napona unutar kućišta proizvoda koji može biti dovoljan da stvori rizik STRUJNOG UDARA</p>	<p>CAUTION</p> <p>RISK OF ELECTRIC SHOCK DO NOT OPEN</p> <p>Upozorenje: Da biste smanjili rizik od strujnog udara nemojte skidati poklopac (ili zadnju stranu). Unutra nema delova koje korisnik može sam da zameni. Za obavljanje servisa zatražite pomoć kvalifikovanog osoblja.</p>	 <p>Znak uzvika unutar jednakostraničnog trougla u ovom uputstvu upozorava korisnika na prisustvo važnih instrukcija za rad i održavanje (servisiranje) uređaja.</p>
--	---	---

Ovaj aparat ne treba izlagati vodi, a predmete ispunjene tečnošću poput vaza ne treba da budu postavljeni na i oko uređaja.

OPREZ

Postoji opasnost od eksplozije ako se baterija nepropisno zameni.

Zamenite postojeću sa samo odgovarajućom vrstom baterije.

Nemojte izlagati bateriju direktnoj sunčevoj svetlosti ili bilo kojem drugom izvoru toplote.

Obezbedite pravilno odlaganje istrošenih baterija.

Ostavite lako dostupnim mesto gde je utikač ili nastavak za prekid napajanja.

Da biste smanjili rizik od strujnog udara, ne obavljajte bilo kakvo servisiranje osim onih koje se pominju u ovom uputstvu.

VAŽNE INFORMACIJE

Ako televizor nije postavljen na dovoljno stabilnom mestu, može postojati potencijalna opasnost od pada.

Mnoge povrede, posebno dečije, mogu se izbeći primenom jednostavnih mera opreza kao što su:

Korišćenje elemenata ili stalaka koje je preporučio proizvođač televizora.

Korišćenje samo onog nameštaja koji može sigurno izdržati uređaj.

Obezbeđivanje uređaja tako da ne prelazi ivicu nameštaja.

Nemojte postavljati TV na visok nameštaj (na primer, ormare ili police) bez prethodnog pričvršćivanja kako nameštaja tako i uređaja na odgovarajuću površinu.

Ne pokrivajte televizor krpom i ne stavljajte drugi materijal između televizora i nameštaja na kom on stoji.



Sigurna instalacija

Koristite pojas za fiksiranje televizora kako bi sprečili uređaj od pada unapred.



1. **Pročitajte uputstva**- Sve napomene o sigurnosti i načinu rada treba pročitati pre uključivanja aparata.
2. **Sačuvajte uputstva** – Uputstva za sigurnost i uputstvo za upotrebu treba da se sačuvaju za buduće potrebe.
3. **Imajte u vidu Upozorenja** – Treba se pridržavati svih upozorenja na aparatu i svih uputstava za upotrebu.
4. **Pratite uputstva**- Treba pratiti sva uputstva.



5. **Voda i vlažnost** – Aparat ne treba koristiti u blizini vode.
6. **Nosač i postolje** – Aparat treba koristiti samo sa nosačem ili postoljem koje preporučuje proizvođač
7. **Montaža na zid ili plafon** – Aparat treba da se montira na zid ili plafon samo po preporuci proizvođača.
8. **Ventilacija** – Aparat treba da bude dobro postavljen, tako da lokacija ili pozicija aparata ne ometaju njegovo provetranje.
9. **Toplota** – Ovaj aparat treba postaviti dalje od izvora toplote kao što su radijatori i peći.
10. **Napajanje** - Aparat treba povezati samo na napajanje kao što je opisano u uputstvima za upotrebu ili onako kako je naznačeno na uređaju.
11. **Uzemljenje ili polarizacija** – Treba preduzeti mere predostrožnosti.
12. **Zaštita kabla za napajanje** – Naponski kabl treba da bude usmeren tako da je malo verovatno da se može gaziti, priklještitu stvarima na njemu i njegovom kraju.
13. **Čišćenje** – Aparat bi trebalo čistiti samo po preporuci proizvođača.
14. Napajanje spoljne antene treba da se nalazi daleko od dalekovoda.
15. **Uzemljenje spoljne antene** – Ako je spoljna antena povezana na prijemnik, antenski sistem mora biti uzemljen kako bi se obezbedila zaštita od naponskog i izvornog statičkog elektriciteta.
16. **Kada ga dugo ne koristite** – napajanje uređaja trebalo bi da bude isključeno iz utičnice kada se ne koristi duži vremenski period.
17. **Upad predmeta i tečnosti** – Treba paziti da predmeti ne upadnu, a tečnost ne prospe u kućište kroz otvore.
18. **Kada je potreban servis** – Aparat treba da servisira kvalifikovano servisno osoblje kada su:
 - Kabal za struju ili utikač oštećeni.
 - Kada predmeti upadnu ili kada se tečnost prolje po uređaju
 - Kada je aparat izložen kiši
 - Kada aparat ne radi normalno ili pokazuje značajnu promenu u radu.
19. Ventilacioni otvori ne bi trebalo da budu pokriveni predmetima, kao sto su novine, tkanine, zavese itd.
20. Izvore otvorenog plamena, kao sto su upaljene sveće, ne bi trebalo da stoje na aparatu
21. Aparat će biti povezan sa mrežnom utičnicom sa zaštitnim uzemljenjem. Utičnica ili nastavak za prekid napajanja trebaju da budu lako dostupni.



UPOZORENJE

Visok napon se koristi u napajanju ovog uređaja. Ne uklanjajte zadnji poklopac. Obratite se kvalifikovanoj osobi za obavljanje servisa.

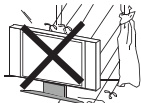

UPOZORENJE

Da biste sprečili požar ili strujni udar, nemojte izlagati uređaj kiši ili vlazi.



UPOZORENJE

Nemojte ispuštati i gurati predmete u kućište TV-a ili u otvore. Nikada nemojte prosipati tečnost na TV prijemnik.

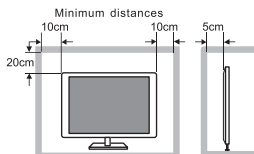

OPREZ

Ako televizor treba da se ugradi u zatvoreni odeljak ili na sličan način, morate se pridržavati dela uputstva o minimalnim udaljenostima. Toplota može smanjiti životni vek televizora, a takođe može biti povećan rizik od požara.



OPREZ

Nikada nemojte da stanete ili se oslonite ili gurnete uređaj ili stalak na kom se uređaj nalazi. Treba obratiti posebnu pažnju na decu.

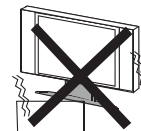

OPREZ

Ne stavljajte glavnu jedinicu na nestabilno postolje, policu ili sto. Usled pada može doći do ozbiljne povrede lica ili štete na televizoru.



OPREZ

Kada se proizvod ne koristi duži vremenski period, preporučljivo je da isključite mrežni kabl iz utičnice .

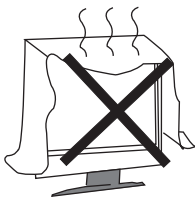

OPREZ

Izbegavajte izlaganje glavne jedinice direktnom suncu i drugim izvorima toplote. Ne postavljajte televizor na druge proizvode koji emituju toplotu. Na primer: Video uređaj, audio pojačala. Ne blokiraj otvore za ventilaciju u zadnjem poklopcu. Ventilacija je od suštinskog značaja za sprečavanje električnih kvarova. Ne stavljajte kabl za napajanje ispod glavne jedinice.



OPREZ

Panel (ekran) koji se koristi u ovom proizvodu napravljen je od stakla. Može se slomiti padom uređaja ili nasilnim udarcem. Pojedinci treba oprezno da rade sa razbijenim staklom ekrana.



- Postavite TV na stabilnu, ravnu površinu, ostavljajući najmanje 10 cm oko njega i 30 cm između vrha seta i zida ili ormarića. Da biste sprečili da se televizor prevrne kada ga gurnete, postavite ga blizu zida. Umesto da držite gornju stranu televizora kada ga okrećete, trebalo bi da držite donju stranu.

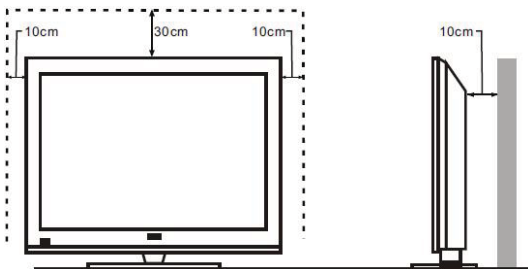

- Izbegavajte rukovanje televizorom samo jednom rukom kada ga podižete; umesto toga, koristite dve ruke.

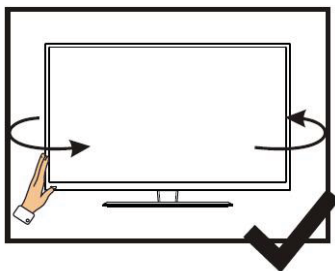
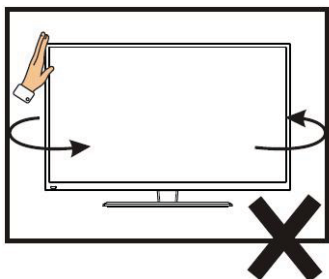

- Izbegavajte rukovanje televizorom samo jednom rukom kada ga podižete; umesto toga, koristite dve ruke.

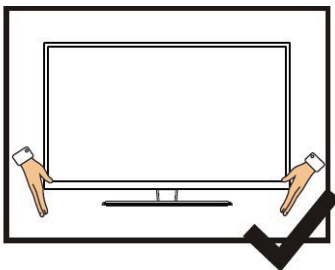
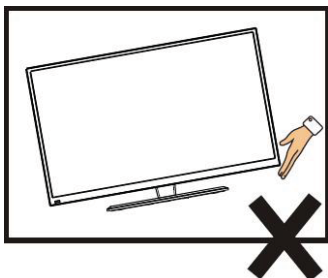

SADRŽAJ

1. Povezivanje i priprema TV-a	2
1.1 Pribor	2
1.2 Postavljanje postolja	2
1.3 Tasteri i interfejs	3
1.4 Daljinski upravljač	4
1.5 Postavljanje baterija	5
2. Osnovni rad	5
2.1 PALJENJE/ GAŠENJE (opcionarno)	5
2.2 Postavljanje načina pripravnosti	5
3. ULAZNI IZVOR	6
4. Opis funkcije menija	6
4.1 MENI KANALA	6
4.1.1 AUTOMATSKO PODEŠAVANJE	7
4.1.2 ATV RUČNO PODEŠAVANJE	7
4.1.3 UREĐIVANJE PROGRAMA	7
4.2 MENI SLIKA	8
4.3 MENI ZVUK	8
4.4 MENI VRIJEME	9
4.5 MENI ZAKLJUČAVANJA	9
4.6 MENI POSTAVLJANJA	10
5. MEDIJI	10
5.1 FOTOGRAFIJA	11
5.2 MUZIKA	12
5.3 FILM	13
5.4 TEKST	14
6. Tehničke specifikacije	15
7. Podržani signalni načini	16
8. Jednostavno rešavanje problema	17

FOX LED TV

1 Priključivanje i priprema TV-a

1.1 Dodatna oprema

- ✧ Uputstvo za korišćenje
- ✧ Daljinsko upravljanje
- ✧ Baterija (UM-4/R03P/AAA)
- ✧ Komplet za montiranje na zid (unapred montiran) (opciono)

1.2 Instalacija postolja

(Molimo pogledajte stvarni objekat za detalje o fizičkoj strukturi.)

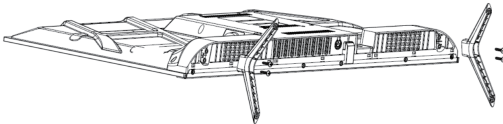

- 1) Postavite TV na mekanu tkaninu ili meke jastuke na sto tako da prednja ploča bude okrenuta nadole.
- 2) Stavite postolje u donju utičnicu televizora.
- 3) Zašrafite utičnice sa zavrtanjima na mestu, a zatim ih zategnite.

FOX LED TV

1.3 TASTERI i interfejsi

Standard dizajna i specifikacije su stvarni proizvodi.

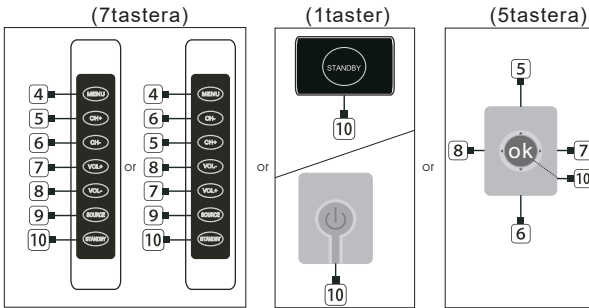
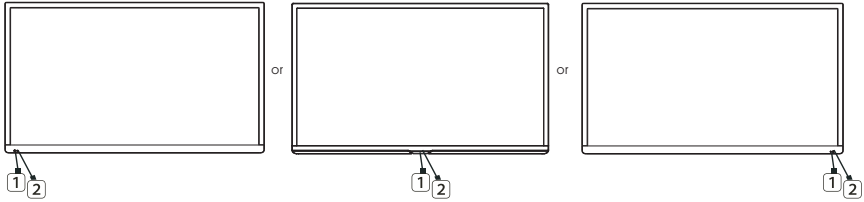

1. PROZOR DALJINSKOG SENZORA
2. INDIKATOR SNAGE
3. GOVORNIK
4. MENU TASTER
5. PROGRAM + TASTER
6. PROGRAM + TASTER
7. VOLUME + TASTER
8. VOLUME + TASTER
9. SOURCE TASTER
10. TASTER PRIPRAVNOSTI
11. ULAZ ZA NAPAJANJE

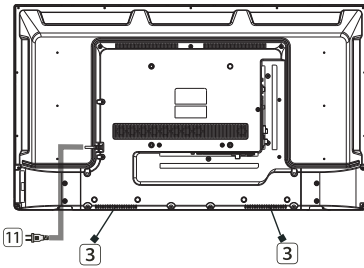

RF IN (S2) 13V/18V==500mA	RF IN (T2)	MINI AV IN	COAXIAL	USB2 USB1 5V==500mA	HDMI1 (ARC)	HDMI2	CI HDMI3	EARPHONE
---------------------------------	---------------	---------------	---------	---------------------------	----------------	-------	-------------	----------

FOX LED TV

1.4 Daljinski upravljač

(Ovde je samo skica, molimo Vas pregledajte)

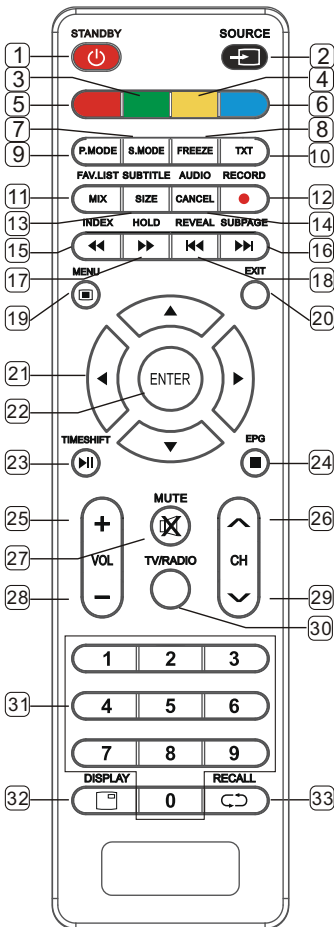

1. STANDBY (): Uključivanje i isključivanje stanja pripravnosti.
2. SOURCE: Izaberite izvor signala.
3. GREEN: Pristupite zelenoj stavci ili stranici.
4. YELLOW: Pristupite žutoj stavci ili stranici.
5. RED: Pristupite crvenoj stavci ili stranici.
6. BLUE: Pristupite plavoj stavci ili stranici.
7. S.MODE: Izaberite režim zvuka.
8. FREEZE: Zamrzni sliku.
9. P.MODE: Izbor režima slike.
10. TXT: Unesite ili izađite iz teleteksta.
11. FAV.LIST: Lista omiljenih kanala.
Or MIX (under TXT): postavljanje prozirnosti.
12. RECORD: DTV režim zapisuj USB disk sa podacima.
13. SUBTITLE: DTV režim bira režim titla.
Or SIZE (under TXT): podešavanje veličine karaktera.
14. AUDIO: Izaberite TV audio režim.
Or SIZE (under TXT): otkazite TXT na ekranu.
15. INDEX: Prikažite indeks stranicu.
MEDIA mode: Brzo unazad.
16. SUBPAGE: Uđite u režim podstranice.
MEDIA mode: Sledeći
17. HOLD: Držite trenutnu stranicu.
MEDIA mode: Brzo unapred.
18. REVEAL: Otkrijte skrivene informacije.
MEDIA Mode: Prethodna.
19. MENU: Unošenje ili izlazak iz menija.
20. EXIT: Izađite iz menija ili operacije.
21. , , , key: Izbor stavke menija.
22. ENTER: Potvrdite ili unesite.
23. TIMESHIFT: Pomeranje vremena u DTV režimu.
MEDIA mode: Pritisnite jednom da biste pauzirali, pritisnite ponovo da biste se repromatisali.
24. EPG: Ulazak ili izlaz iz EPG-a (vodič za elektronski program)
MEDIA mode: Zaustavite reprodukciju i vratite se na listu datoteka.
25. VOL+: Povećajte jačinu zvuka.
26. CH^: Izaberite kanal unapred.
27. MUTE: Utišajte zvuk.
28. VOL-: Smanjite jačinu zvuka.
29. CHv: Izaberite kanal unazad.
30. TV/RADIO: Izaberite TV ili radio režim.
31. 0-9: Ponovo pritisnite dugmad da biste izabrali kanal.
32. DISPLAY: Prikažite informacije o trenutnom videu i zvuku.
33. RECALL: Vratite se na prethodni kanal.

FOX LED TV

1.5 Instalacija baterija

(Molim vas da prevladate, ovo je samo skica.)



- 1 Zadnji poklopac daljinskog upravljača treba da bude otvoren.
- 2 Stavite dve 7# (AAA) 1.5V baterije u sistem.

Uverite se da su baterije pravilno polarizovane.

- 3 Zatvorite zadnji poklopac.

Izvadite baterije iz daljinskog upravljača ako ga neko vreme ne koristite.

Izvršite sledeće provere ako daljinski upravljač ne funkcioniše ispravno.

- Proverite da li je TV u programu.
- Proverite da li je polaritet baterija odgovarajući.
- Proverite da li baterije nisu istršene.
- Uverite se da je napajanje u ispravnom stanju ili da je kabl za napajanje pravilno povezan.
- Uverite se da u blizini nema neobičnih neonskih ili fluorescentnih svetla.



2 Osnovna operacija

2.1 Uključivanje/isključivanje (opciono)

- Povežite kabl za napajanje sa **AC ulazom** . Priključite kabl za napajanje u odgovarajuću utičnicu.
- Pritisnite **Taster d** a uključite TV, zatim pritisnite **Napajanje** taster za uključivanje uređaja.
- Pritisnite **Taster p** onovo da isključite TV.

Beleška: Nemojte odmah ponovo da pritisnete prekidač za napajanje nakon što isključite TV; umesto toga, sačekajte jedan minut pre nego što ponovo pritisnete prekidač za napajanje.

2.2 Podešavanje režima pripravnosti

- Pritisnite () taster da biste uključili jedinicu.
- Pritisnite () taster ponovo da vratite ekran u režim pripravnosti. Indikator napajanja svetli crveno.
- Uverite se da vaš TV nije ostavljen u režimu pripravnosti duži vremenski period.

2.3 Izbor režima unosa

Ovaj TV sadrži više modova izvora signala; pritisnite dugme **Source** više puta da biste izabrali izvor signala.

3. ULAZNI IZVOR

- ✧ Pritisnite IZVOR za prikaz liste izvora unosa;
- ✧ Pritisnite taster ▲/▼ za odabir i ENTER za potvrdu;
- ✧ Ovaj meni će se automatski sakriti za nekoliko sekundi ili pritisnite EXIT za brisanje menija na ekranu.

4. Opis funkcije menija

4.1 MENI KANALA

- ✧ Meni kanala dostupan je samo u DTV načinu rada

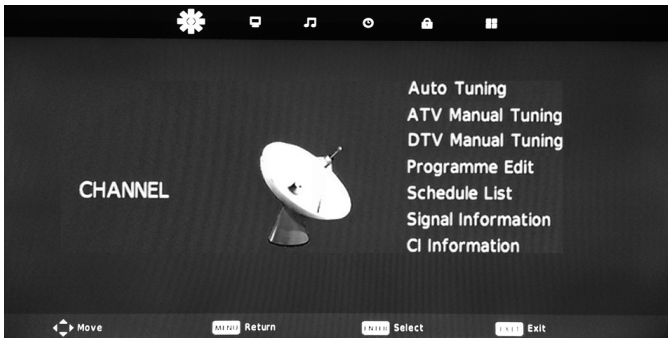

FOX LED TV

4.1.1 AUTOMATSKO PODEŠAVANJE

- ✧ Automatsko podešavanje može automatski pronaći sve efektivne kanale.
- ✧ Pritisnite ▲/▼ za odabir automatskog podešavanja, zatim pritisnite ENTER za početak automatskog pretraživanja.
- ✧ Ako želite da zaustavite traženje, pritisnite EXIT i pritisnite ◀ za potvrdu ili ▶ za otkazivanje.



4.1.2 ATV RUČNO PODEŠAVANJE

- ✧ Ručno podešavanje može pretraživati prema gore ili dole, i zaustaviće se kada pronađe kanal.
- ✧ Pritisnite ◀ za pretraživanje prema dole od trenutne frekvencije i pritisnite ▶ za pretragu na gore.



4.1.3 UREĐIVANJE PROGRAMA



Postoje četiri tastera za prečice za programiranje kanala. Najpre pritisnite ▼/▲ za isticanje kanala , zatim:

- ✧ **Obrisati:** Obrisite kanal.
- ✧ **Promeniti naziv:** Unesite status promene naziva a zatim pritisnite ◀/▶ za odabir reči koju želite promeniti i pritisnite ▼/▲ za odabir znaka.
- ✧ **Premestiti:** Postavite kanal na stanje pomeranja a zatim pritisnite ▼/▲ za njegovo pomeranje u položaj koji želite.
- ✧ **Preskočiti:** Preskočite odabrani kanal. (Vaš TV prijemnik će automatski preskočiti kanal kada koristite CH+/- .)
- ✧ **ENTER:** Pritisnite za potvrdu.
- ✧ **Meni:** Pritisnite za povratak na prethodni meni.

FOX LED TV

4.2 MENI SLIKA

- ✧ Pritisnite meni za prikaz glavnog menija i pritisnite ◀/▶ za izbor menija slika. Istaknite podešavanje i pritisnite ▼/▲ za izbor odgovarajućeg menija.
- ✧ **Način rada Slika** : Dinamično/Standardno/Blago/Lično
- ✧ **Temp boje**: Izaberite temperaturu boje da se osećate ugodno dok gledate TV.
- ✧ **Smanjenje smetnje**: Možete ulazni signal očistiti od smetnji.

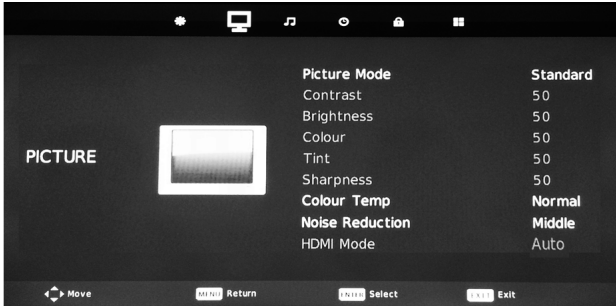

4.3 MENI ZVUK

- ✧ Pritisnite meni za prikaz glavnog menija i pritisnite ◀/▶ za izbor menija zvuk.
- ✧ **Način rada zvuk**: Standardno/muzika/Filmovi/Sportovi/Lično
- ✧ **Ravnoteža**: Podesite nivo zvuka koji dolazi iz levog i desnog zvučnika.
- ✧ **Automatski nivo glasnoće**: Kada je uključeno, brza promena glasnoće biće podesena.
- ✧ **SPDIF NAČIN**: Pritisnite za izbor Isključeno/PCM/Automatski
- ✧ **Prekidač AD**: Pritisnite za izbor zvuka.

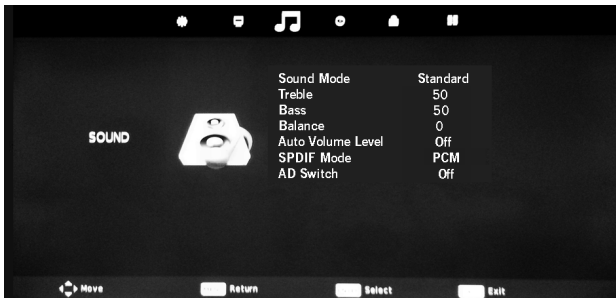

FOX LED TV

4.4 MENI VREME

- ✧ Pritisnite meni za prikaz glavnog menija i pritisnite ◀/▶ za izbor menija vreme.
- ✧ **Sat:** Postavite vreme sisetema.
- ✧ **Vremenska zona:** odaberite vremensku zonu
- ✧ **Vreme mirovanja:** Odaberite vreme u minutama.
kada želite da se TV automatski isključi nakon što postavite vreme. Otkazite postavljanjem na Isključeno.
- ✧ Automatsko stanje pripravnosti: Pritisnite da potvrdite.
- ✧ **Osđ Merač vremena:** Postavite vreme prikaza OSD-a.



4.5 MENI ZAKLJUČAVANJA

- ✧ Pritisnite meni za prikaz glavnog menija i pritisnite ◀/▶ za izbor menija zaključavanja.
- ✧ **Zaključavanje sistema:** Prekidač za zaključavanje sistema..
- ✧ **Postaviti lozinku:** Postavite zaključavanje lozinke sistema.
- ✧ Zaključavanje kanala: Pritisnite zeleno taster za zaključavanje ili otključavanje kanala.
- ✧ Roditeljski nadzor: Odaberite godinne koje odgovaraju Vašoj deci.
- ✧ Zaključavanje tastera: Za izbor Isključeno ili Uključeno.
- ✧ Hotelski način: Za izbor Isključeno ili Uključeno.



FOX LED TV

4.6 MENI POSTAVLJANJA

- ✧ Pritisnite meni za prikaz glavnog menija i pritisnite ◀/▶ za izbor menija opcije.
- ✧ **Jezik:** Postavite OSD jezik prikaza.
- ✧ **TT Jezik:** Pritisnite taster ▼/▲/◀/▶ za izbor TT jezika.
- ✧ Audio jezici/Jezik titlova: Pritisnite za izbor podešavanja.
- ✧ Osobe oštećenog sluha: Pritisnite za postavljanje Lica oštećenog sluha na „Uključeno” ili „Isključeno”.
- ✧ **PVR Sistem datoteka:** Postavite sistemom datoteka za snimanje.
- ✧ **Postavljanje po prvi put:** Pritisnite ▶ “ili „OK” za unos relevantnih opcija uključujući OSD jezik i zemlju.
- ✧ **Resetovati :** Vratiti se na zadane postavke.
- ✧ **Ažuriranje softvera (USB):** Za nadogradnju softvera.
- ✧ **Okolina:** Pritisnite za postavljanje Energy Star na „Home Mode” ili „Shop Mode”.



5. MEDIJI

Boja ikone znači da li je Vaš TV detektovao USB memoriju ili ne.
Plavo: Da; Sivo; Ne;

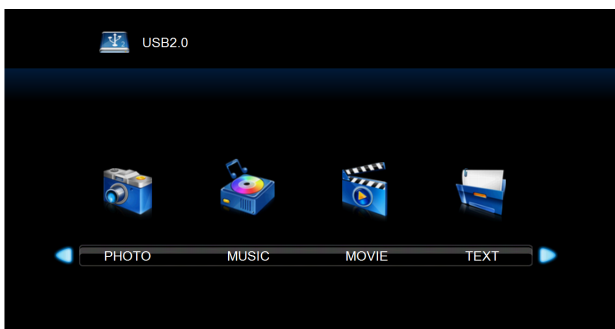

Pritisnite ◀/▶ za izbor ikone Fotografija/Muzika/Film/Tekst i ENTER za ulazak u USB memoriju.

Za detalje,

FOX LED TV

5.1 FOTOGRAFIJA



Odaberite slikovnu datoteku i pritisnite ENTER za pregled, a automatski će se prikazati sve slike u mapi. Pritisnite ENTER za prikaz sledećeg menija.

ZAUSTAVITI

SLEDEĆI/

PRETHODNI

ZAUSTAVITI

PONOVI SVE

MUZIKA

Lista za reprodukciju

INFO.

OKRENUTI

Povećati prikaz

Umanjiti prikaz

POMAĆI PREGLED

Pritisnite taster „PAUZA” da biste zaustavili slajd.

Pritisnite „SLEDEĆI/ PRETHODNI” taster za preskakanje za pregled fotografija što predstavlja izabranu fotografiju.

Pritisnite taster „STOP” da biste zaustavili i vratili.

Pritisnite ENTER za izbor načina ponavljanja: Ponovite 1/SVE/Ništa.

Pritisnite za reprodukciju ili zaustavljanje pozadinske muzike.

Pritisnite za pregled liste slika.

Pritisnite za prikaz informacija o trenutnoj slici (Rezolucija/Veličina/Datum/Vreme)

Okrenite u smeru suprotnom od kazaljke na satu.

Povećajte prikaz slike.

Umanjite prikaz slike.

Najpre umanjite pregled slike. Označite ikonicu i pritisnite ENTER, zatim pritisnite ▼/▲&◀/▶ za pomicanje slike.

5.2 MUZIKA

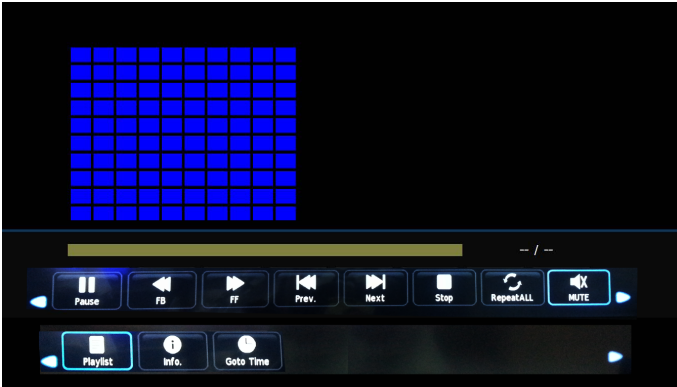

Pritisnite ENTER kako bi se prikazao glavni meni.

REPRODUKOVANJE

Pritisnite za pokretanje ili zaustavljanje.

FB

Pritisnite za pokretanje ili sporiji rad.

FF

Pritisnite za pokretanje ili brži rad.

PRETHODNO

Pritisnite za pokretanje prethodne pesme.

SLEDEĆE

Pritisnite za pokretanje sledeće pesme.

ZAUSTAVITI

Pritisnite za zaustavljanje i vraćanje na interfejs mape.

PONOVITI SVE

Pritisnite za izbor načina ponavljanja: Ponovite 1/SVE/Ništa.

ISKLUČITI TON

Pritisnite za isključivanje tona.

Popis za reprodukciju

Odaberite „popis za reprodukciju“ za prikaz liste za reprodukciju

INFO.

Odaberite „info“ za prikaz informacija o muzici.

Odabрати GOTO TIME

Odaberite „goto time“ za postavljanje vremena reprodukcije.

5.3 FILM

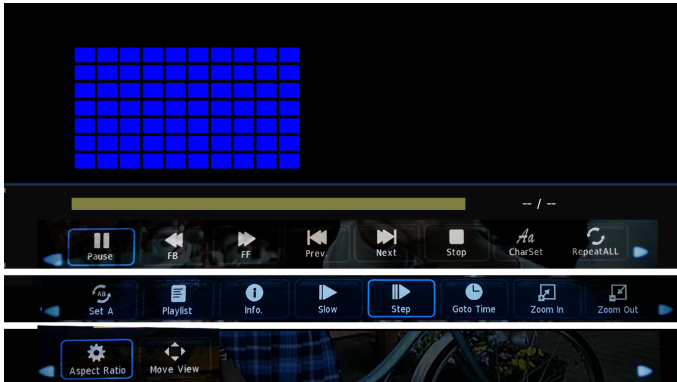

Pritisnite ENTER kako bi se prikazao glavni meni.

REPRODUKCIJA/ PAUZIRANJE Pritisnite za pokretanje ili pauziranje

FB Pritisnite za pokretanje ili sporiji rad.

FF Pritisnite za pokretanje ili brži rad.

PRETHODNO Pritisnite za pokretanje prethodnog filma.

SLEDEĆE Pritisnite za pokretanje sledećeg filma.

ZAUSTAVITI Pritisnite za zaustavljanje i vraćanje na interfejs mape.

SET ZNAKOVA Pritisnite za izbor seta znakova

PONOVITI SVE Pritisnite za izbor načina ponavljanja: Ponovite 1/SVE/NIŠTA.

POSTAVITI Odabrati način AB.

Popis za reprodukciju Pritisnite za pregled popisa slika

INFO. Pritisnite za prikaz informacija o trenutnom filmu

SPORO NAPRED Sporo napred

ZAKORAČITI NAPRED Zakoračiti napred

GOTO TIME Odaberite „goto time“ za postavljanje vremena reprodukcije.

Povećati prikaz Povećajte prikaz filma.

Umanjiti prikaz Umanjite prikaz filma.

Odnosi širine i visine slike Auto/4:3/ 16:9 /Zoom1/Zoom2

POMAĆI PREGLED Najpre povećajte pregled slike. Označite ikonicu i pritisnite ENTER, zatim pritisnite ▼/▲& ◀/▶ za pomeranje filma.

5.4 TEKST

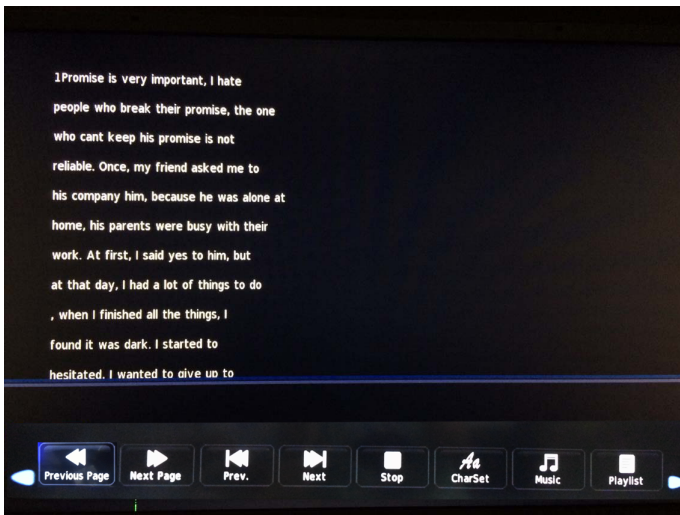

Prethodna stranica

Pritisnite za odlazak na prethodnu stranicu

Sljedeća s tranica

Pritisnite za odlazak na sljedeću stranicu

PRETHODNO

Pritisnite za pokretanje prethodnog teksta.

SLEDEĆE

Pritisnite za pokretanje sledećeg teksta.

ZAUSTAVITI

Pritisnite za zaustavljanje i vraćanje na interfejs mape.

MUZIKA

Pritisnite za reprodukciju ili zaustavljanje pozadinske muzike.

Popis za reprodukciju

Pritisnite za pregled popisa tekstova.

FOX LED TV

6. Tehničke specifikacije

Model proizvoda	32DTV231E	
Veličina ekrana	32" dijagonala	
Format prikaza	16:9	
Napajanje	AC 100-240V~,50/60Hz	
Potrošnja električne energije	60W	
TV Sistem	PAL B/G D/K I,SECAM B/G D/K DVB-T/T2/C/S/S2(s/s2 opcija) (U nekim zemljama ili područjima nema DVB-C signala.)	
Izlazna audio snaga (interna)	8WX2	
Ulazni terminal	Ulaz antene	x 2 (S2 opcija)
	USB ulaz	x 2
	HDMI ulaz	x 3
	VGA ulaz	NO
	PC AUDIO Ulaz	NO
	Audio Ulaz (L/R)	x 1(mini)
	Video Ulaz	x 1(mini)
	YPbPr Ulaz	NO
	RJ45 Ulaz	NO
	CI kartica In	x 1
	SCART In/Izlaz	NO
	DC In (12V)	NO
	UTOR ZA KARTICU	NO
Izlazni terminal	Slušalice	x 1
	Audio Linija Izvan (L/R)	NO
	Video izlaz	NO
	Optičko	NO
	Koaksijalni izlaz	x 1
Radna temperatura	0°C~40°C	
Radna vlažnost	20% ~ 80% bez kondenzacije	

Zabeleška: Gore prikazane specifikacije mogu da se promene bez prethodne obavesti radi poboljšanja kvaliteta.



Proizvedeno pod licencom kompanije Dolby Laboratories. Dolby, Dolby Audio i dvostruki D simbol su žigovi kompanije Dolby Laboratories Licensing Corporation.

FOX LED TV

7. Podrška Signalni načini

A. HDMI režim

Rezolucija	Horizontalna frekvencija (Khz)	Vertikalna frekvencija (Hz)
480p	31.468	59.94
576p	31.25	50.00
720P	45.00	60.00
1080i	33.75	60.00
1080P(1920x1080)	67.50	60.00

-Kada signal koji prima ekran pređe dopušteni raspon, na ekranu će se pojaviti poruka upozorenja.

-Možete da potvrdite format ulaznog signala na ekranu.



Izrazi HDMI, HDMI High-Definition Multimedia Interface, HDMI prepoznatljiv vizuelni identitet i HDMI logotipi su žigovi ili registrovani žigovi kompanije HDMI Licensing Administrator, Inc.

8 Jednostavno otklanjanje poteškoća

Ako ekran pokvari ili se njegove performanse drastično promene, proverite ekran u skladu sa smernicama u nastavku. Ne zaboravite da pregledate periferne uređaje kako biste identifikovali koren problema.

Problem	Rešenje
Napajanje se ne može aktivirati. (Indikator napajanja ne svetli.)	-Potvrdite da su oba kraja kabla za napajanje pravilno umetnuta u utičnicu i da li je zidna utičnica funkcionalna.
Prikazuje se poruka Nema ulaznog signala.	- Proverite da li je signalna linija ispravno povezana. -Potvrdite da su relevantni periferni uređaji uključeni. -Uverite se da izabrani izbor ulaza odgovara ulaznom signalu.
Daljinski upravljač ne radi ispravno.	-Proverite da baterije nisu istrošene. (Koristite novu bateriju.) -Potvrdite da daljinski upravljač radi u svom dometu. - Uverite se da je daljinski upravljač usmeren ka prozoru daljinskog upravljača ekrana. - Uverite se da nema prepreka između daljinskog upravljača i njegovog prozora.
Na ekranu se nalaze trepćuće tačke ili pruge.	- Uverite se da nema emisija (auto, VN žice ili neonske sijalice) ili drugih potencijalnih izvora smetnji.
Boja ili kvalitet slike se pogoršavaju.	- Proverite da li su sva video podešavanja, kao što su osvetljenost, kontrast i boja, pravilno podešena. -Za dodatne informacije o video postavkama, pogledajte OSD funkcije poglavlja 2.
Položaj i veličina ekrana su netačni.	-Potvrdite da su pozicija i veličina ekrana na odgovarajući način.
Slika ili boja su netačne.	- Proverite da li je signalna linija ispravno povezana. -Kada ste povezani sa računarnom, možete da promenite rezoluciju računara da biste dobili odgovarajuću sliku. Disparitet u izlaznom signalu računara može uticati na prikaz slike.
Prikažite poruku upozorenja.	- Proverite da li je ulazna linija signala na odgovarajući način obezbeđena. -Izaberite odgovarajući ulazni signal. -Pogledajte Podržani režimi signala u poglavlju 4 za dodatne informacije.



USER MANUAL

LED Television **Model: 32DTV231E**

Thank you for purchasing this device.

FOX LED televisions are known for their great performance, as for modern, functional and elegant design. Besides that, we constantly improve our customer support, we have highly efficient and wide network of services, that make our proud customers feel safe.

You made a right choice.



Now it's time for instructions, they are not complicated, but you have to follow them.

EN

IMPORTANT SAFETY INSTRUCTIONS

WARNING

- TO PREVENT FIRE OR SHOCK HAZARD, DO NOT USE AN EXTENSION CORD, RECEPTACLE OR OTHER OUTLET UNLESS THE BLADES CAN BE TO PREVENT BLADE EXPOSURE.
- TO PREVENT FIRE OR SHOCK HAZARD, DO NOT EXPOSE THIS APPLIANCE TO RAIN OR MOISTURE.

	CAUTION RISK OF ELECTRIC SHOCK DO NOT OPEN	
<p>This lightning flash with arrowhead symbol in an equilateral triangle alerts users to the presence of uninsulated dangerous voltage within the products enclosure that may be of sufficient magnitude to constitute a risk of electric shock.</p>	<p>Warning: To reduce the risk of electric shock, do not remove cover (or back). No user serviceable parts inside. Refer servicing to qualified service personnel.</p>	<p>The exclamation mark within an equilateral triangle alerts users to the presence of important operating and maintenance (servicing) instructions in the literature accompanying the appliance.</p>

This appliance should not be exposed to water and no object filled with liquid such as a vase should be placed on the unit.

CAUTION

- Danger of explosion if batteries are incorrectly replaced.
- Replace with only equivalent type of battery.
- Do not expose battery to direct sunlight or any other source of heat.
- Ensure proper disposal of used batteries.
- Where the MAINS plug or an appliance coupler is used as the disconnect device, the disconnect device shall remain readily operable.
- To reduce the risk of electric shock, do not perform any servicing other than what is mentioned in the operating manual.
- There are no user-serviceable parts inside the TV; do not open the TV casing.

IMPORTANT INFORMATION

If a television is not positioned in a sufficiently stable location, it can be potentially hazardous due to falling. Many injuries, particularly to children, can be avoided by taking simple precautions such as:

- Using cabinets or stands recommended by the manufacturer of the television.
- Only using furniture that can safely support the television.
- Ensuring the television is not overhanging the edge of the supporting furniture.
- Not placing the television on tall furniture (for example, cupboards or bookcases) without anchoring both the furniture and the television to a suitable support.
- Not standing the televisions on cloth or other materials placed between the television and supporting furniture.
- Educating children about the dangers of climbing on furniture to reach the television or its controls.



Safe installation

Use the belt fixing the television to facilitate restraining the television from toping forward.



1. **Read Instructions** - All the safety and operating instructions should be read before the appliance is operated.
2. **Retain Instructions** - The safety and operating instructions should be retained for future reference.
3. **Heed Warnings** - All warnings on the appliance and in the operating instructions should be adhered to.
4. **Follow Instructions** - All operating instructions should be followed.



5. **Water and Moisture** - The appliance should not be used near water.
6. **Cart and Stands** - The appliance should only be used with a cart or stand that is recommended by the manufacturer.
7. **Wall or Ceiling Mounting** - The appliance should be mounted to a wall or ceiling only as recommended by the manufacturer.
8. **Ventilation** - The appliance should be well situated so that its location or position does not interfere with its proper ventilation.
9. **Heat** - This appliance should be placed away from heat sources such as radiators, heat registers and stoves.
10. **Power Sources** - The appliance should only be connected to a power supply as described in the operating instructions or as marked on the appliance.
11. **Grounding or Polarization** - Precautions should be taken.
12. **Power Cord Protection** - Power supply cord should be routed so that it is not likely to be walked on, pinched by items placed upon it against the cord and its end.
13. **Cleaning** - The appliance should be cleaned only as recommended by the manufacturer.
14. **Power Line** - An outdoor antenna should be located away from power lines.
15. **Outdoor Antenna Grounding** - If an outside antenna is connected to the receiver, the antenna system must be grounded so as to provide against voltages and built-up static charges.
16. **Non-use Periods** - The power cord of the appliance should be unplugged from the outlet when left unused for a long period of time.
17. **Object and Liquid Entry** - Care should be taken so that objects did not fall, and liquids are not spilled into the enclosure through openings.
18. **Conditions requiring Service** - The appliance should be serviced by qualified service personnel when:
 - The power-supply cord or the plug has been damaged.
 - Objects have fallen on or liquid has been spilled into the appliance.
 - The appliance has been exposed to rain.
 - The appliance does not appear to operate normally or exhibits a marked change in performance.
19. The ventilation should not be impeded by covering the ventilation opening with items, such as newspapers, table-cloths,curtains,etc.
No naked flame sources, such as lighted candles, should be placed on the apparatus.
The apparatus shall be connected to mains socket outlet with a protective earthing connection.
The appliance coupler regard as disconnection device, the disconnect device shall remain readily operable.

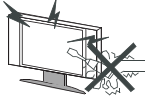

Warning

High voltages are used in the operating of this product. Do not remove the back cover of the cabinet. Refer servicing to qualified service personnel.

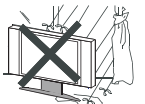

Warning

To prevent fire or electrical shock hazard, do not expose the main unit to rain or moisture.



Warning

Do not drop or push objects into television cabinet slots or openings. Never spill any kind of liquid on the television receiver.

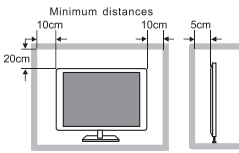

Caution

If the television is to be built into a compartment or similarly enclosed, the minimum distances must be maintained.

Heat built up can reduce the service life of your television, and can also be dangerous.



Caution

Never stand on, lean on, push suddenly the product or its stand.

You should pay special attention to children.

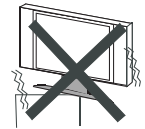

Caution

Do not place the main unit on an unstable cart stand, shelf or table.

Serious injury to an individual, and damage to the television, may result should it fall.

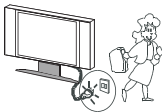

Caution

When the product is not used for an extended period of time, it is advisable to disconnect the AC power cord from the AC outlet.

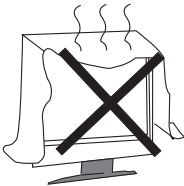

Caution

Avoid exposing the main unit to direct sunlight and other sources of heat. Do not position television receiver directly on other products which give off heat. E.g. Video cassette players, audio amplifiers. Do not block the ventilation holes in the back cover. Ventilation is essential to prevent electrical failure. Do not squash power supply cord under the main unit.



Caution

The panel used in this product is made of glass. It can break when the product is dropped or applied with force.

Individuals should execute caution when dealing with broken glass should the panel break.



- Place the TV on a firm and flat surface, leaving a space of at least 10cm around the set and 30cm from the top of the set to the wall or cabinet. Ensure the TV is positioned close to the wall to avoid it falling when pushed.

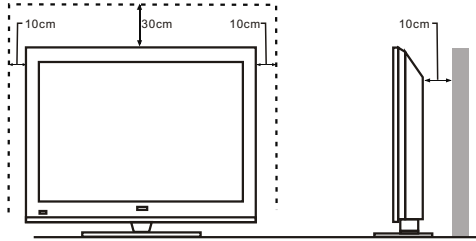

- When you turning the TV set, do not hold the top side of the TV set, you should hold the bottom side.

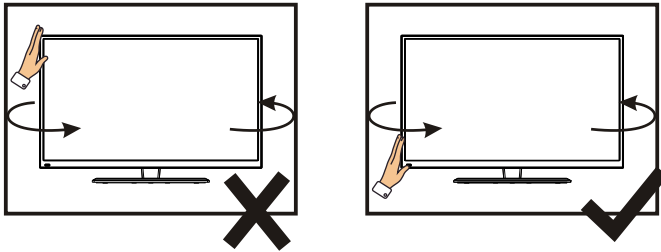

- When you lifting the TV set, do not use one hand to handle it, you should lift the TV set by two hands.

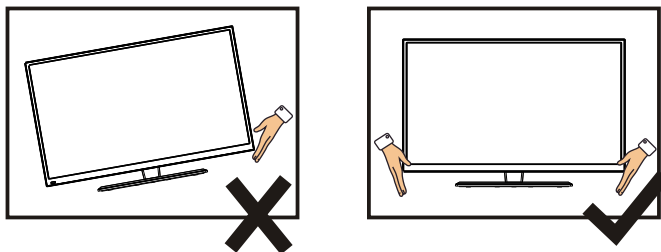

LED COLOR TV

CONTENTS

1. Connection and Preparation of TV.....	2
1.1 Accessories	2
1.2 Installation of Stand.....	2
1.3 Keys and Interfaces.....	3
1.4 Remote Control.....	4
1.5 Installation of Batteries.....	5
2. Basic Operation.....	5
2.1 Power ON/OFF(optional).....	5
2.2 Setting of Standby Mode.....	5
3.INPUT SOURCE	6
4.Menu Function Description	6
4.1CHANNEL MENU.....	6
4.1.1 AUTO TUNING	7
4.1.2 ATV MANUAL TUNING	7
4.1.3 PROGRAMME EDIT.....	7
4.2 PICTURE MENU	8
4.3 SOUND MENU	8
4.4 TIME MENU	9
4.5 LOCK MENU	9
4.6 SETUP MENU.....	10
5. MEDIA	10
5.1 PHOTO.....	11
5.2 MUSIC	12
5.3 MOVIE	13
5.4 TEXT	14
6. Technical Specification.....	15
7. Supported Signal Modes.....	16
8. Simple Troubleshooting	17

LED COLOR TV

1.Connection and Preparation of TV

1.1 Accessories

- ★ User Manual
- ★ Remote Control
- ★ Battery(UM-4/R03P/AAA)
- ★ Wall Mount Kit (Pre-assembled)(Optional)

1.2 Installation of Stand

(For the physical structure, please refer to the real object)

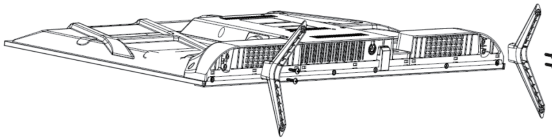

- ① Place the TV with the front panel facing downwards on the soft cloth or soft pads on a desk.
- ② Insert the stand into the bottom socket of the TV.
- ③ Insert the screws into the sockets and tighten them.

LED COLOR TV

1.3 Keys and Interfaces

The design and specification takes actual products as the standard

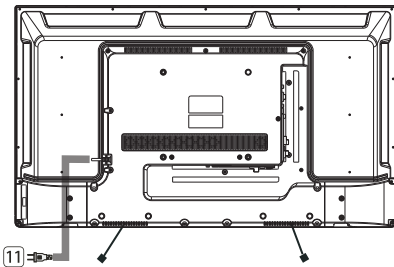
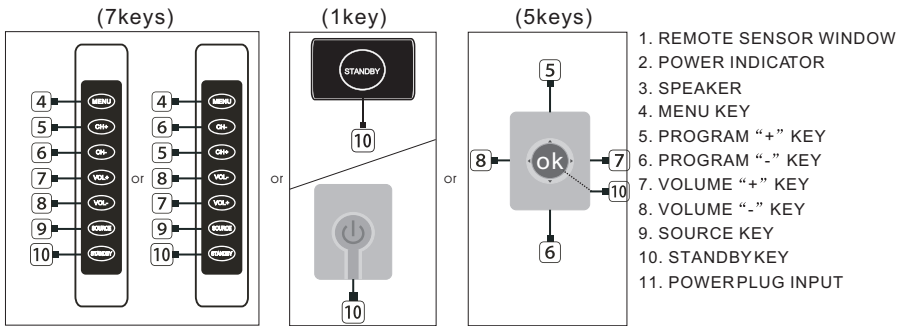
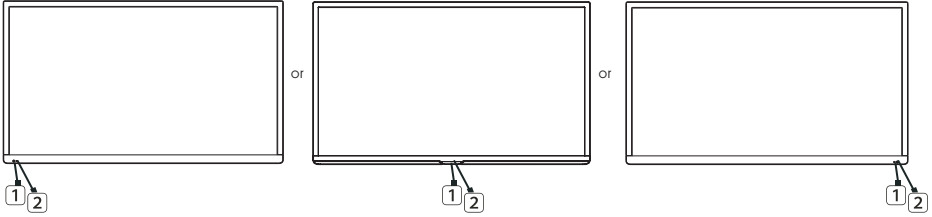

RF IN (S2) 13V/18V==500mA	RF IN (T2)	MINI AV IN	COAXIAL	USB2 USB1 5V==500mA	HDMI1 (ARC)	HDMI2	CI HDMI3	EARPHONE
---------------------------------	---------------	---------------	---------	---------------------------	----------------	-------	-------------	----------

LED COLOR TV

1.4 Remote Control

(Here is only the sketch, please in kind prevail)

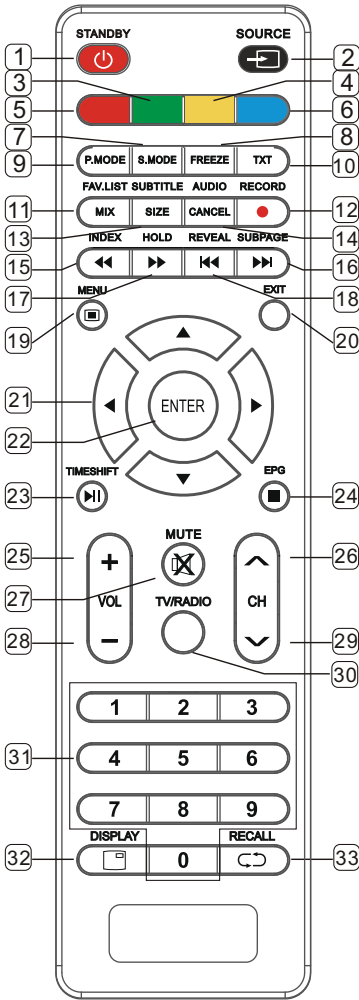

1. STANDBY(⏻) : Standby turn on and off.
2. SOURCE: Select the signal source.
3. GREEN: Access the green item or page.
4. YELLOW: Access the yellow item or page.
5. RED: Access the red item or page.
6. BLUE: Access the blue item or page.
7. S.MODE: Select the sound mode.
8. FREEZE : Freeze the picture.
- 9 P.MODE: Select the picture Mode.
10. TXT: Enter or exit teletext.
11. FAV.LIST: Favorite channel list.
Or MIX (under TXT): setting transparency.
12. RECORD: DTV mode record data USB disk.
13. SUBTITLE: DTV mode select subtitle mode.
Or SIZE (under TXT): setting sizes of the character.
14. AUDIO: Select TV audio mode.
Or CANCEL (under TXT): cancel the TXT on screen.
15. INDEX: Display the index page.
MEDIA mode: ◀◀ Fast Backward
16. SUBPAGE: Enter the sub page mode.
MEDIA mode: ▶▶ Next
17. HOLD: Hold the current page.
MEDIA mode: ▶▶ Fast Forward
18. REVEAL: Reveal the hidden information.
MEDIA Mode: ◀◀ Previous.
19. MENU : Enter or exit menu.
20. EXIT : Exit menu or operation.
21. ▲,▼,◀,▶ key: The menu item selection.
22. ENTER: Confirm or enter.
23. TIMESHIFT: DTV mode time shift.
MEDIA mode: ▶▶ Press one time to pause, press again to playback.
24. EPG: Enter or exit EPG(Electronic Program .Guide)
MEDIA mode: ■ Stop the playback and return to file list.
25. VOL+: Increase the volume.
26. CH▲: Select the channel forward.
27. MUTE: Mute sound.
28. VOL -: Decrease the volume.
29. CH▼ : Select the channel backward.
30. TV/RADIO: Select the TV or Radio mode.
31. 0~9 : Continue to press the keys to select a channel.
32. DISPLAY : Display the information of current video and audio.
33. RECALL: Return to previous channel.

LED COLOR TV

1.5 Installation of Batteries

(Here is only the sketch, please in kind prevail)

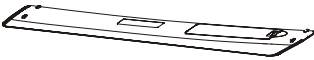

- ① Open the back lid of the remote control.
- ② Install two 7#(AAA)1.5V batteries.
Ensure the correct polarity of the batteries.
- ③ Cover the back lid.
Please take out of the batteries from the remote control for long time of no use.

If the remote control doesn't work properly, please carry out the following checks.

- Check the TV is turned on.
- Check the polarity of the batteries are correct.
- Check the batteries are not drained.
- Check the power supply is normal or the power cord is correctly connected.
- Check there are no special fluorescent light or neon light around.



2. Basic Operation

2.1 Power ON/OFF(optional)

- Connect the power cord to the **AC input**. Insert the power cord into the appropriate socket.
- Press the **Power switch** to switch on the TV, then press **Power** button to turn on the unit.
- Press the **Power switch** again to switch off the TV.

Note: After switch off the TV, please don't immediately re-open the power switch ,should be delayed one minute more to re-open the power switch.

2.2 Setting of Standby Mode

- Press () button to turn on the unit.
- Press () button again to return the display to standby mode. The power indicator turns red.
- Be sure not to set your TV in standby mode for a long period of time.

LED COLOR TV

3、 INPUT SOURCE

- ✧ Press SOURCE to show input source list.
- ✧ Press ▲/▼ to select and ENTER to confirm.
- ✧ The menu will be automatically hidden in a few seconds, or press EXIT to clear on-screen menu.

4、 Menu Function Description

4.1 CHANNEL MENU

- ✧ The channel menu is available only in DTV mode.

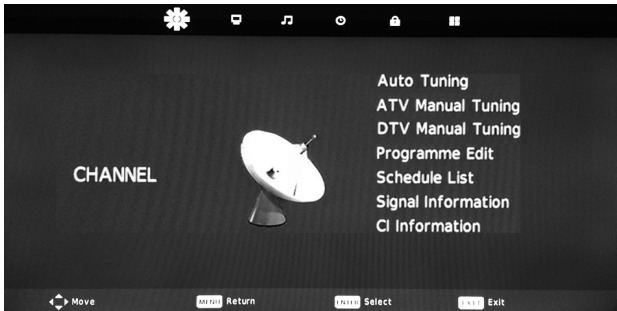

LED COLOR TV

4.1.1 AUTO TUNING

- ✧ Auto Tuning can find out all effective channel automatically.
- ✧ Press ▲/▼ to select Auto Tuning, then press ENTER to start auto searching.
- ✧ If you want to stop searching, press EXIT, and press ◀ to confirm or ▶ to cancel.



4.1.2 ATV MANUAL TUNING

- ✧ Manul Tuning can search up or down, and will pause when find a channel.
- ✧ Press ◀ to search down from the current frequency, and press ▶ to search up.



4.1.3 PROGRAMME EDIT



There are four shortcut keys for programming the channel.

First press ▼/▲ to highlight the channel , then:

- ✧ **Delete:** Delete the channel.
- ✧ **Rename:** Enter rename state, then press ◀ /▶ to select the word you want to change, and press ▼/▲ to select a character.
- ✧ **Move:** Set the channel to moving state then press ▼/▲ to move it to the position you want.
- ✧ **Skip:** Skip the selected channel. (Your TV set will skip the channel automatically when using CH+/-.)
- ✧ **ENTER:** Press to confirm.
- ✧ **Menu:** Press to return to previous menu.

LED COLOR TV

4.2 PICTURE MENU

- ✧ Press MENU to display the main menu, and press ◀/▶ to select the Picture Menu. Highlight the item and press ▼/▲ to select corresponding sub-menu.
- ✧ **Picture Mode** : Dynamic/Standard/Mild/Personal
- ✧ **Color Temp**: Select the color temperature that you feel comfortable.
- ✧ **Noise Reduction**:You can clear up input signal by set the item.

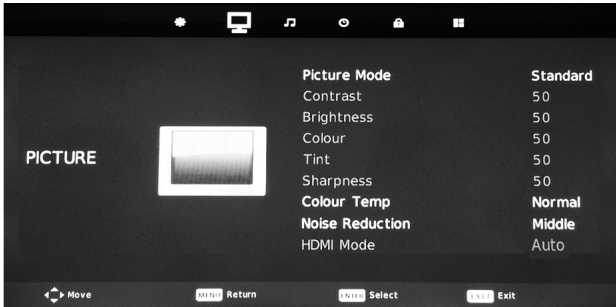

4.3 SOUND MENU

- ✧ Press MENU to display the main menu, and press ◀/▶ to select the Sound Menu.
- ✧ **Sound Mode**: Standard/Music/Movie/Sports/Personal
- ✧ **Balance**: Adjust the level of sound coming from the left and right speakers.
- ✧ **Auto Volume Level**: When set on, quick volume change will be smoothed.
- ✧ SPDIF MODE:Press to select Off/PCM/Auto
- ✧ AD Switch:Press to select audio.

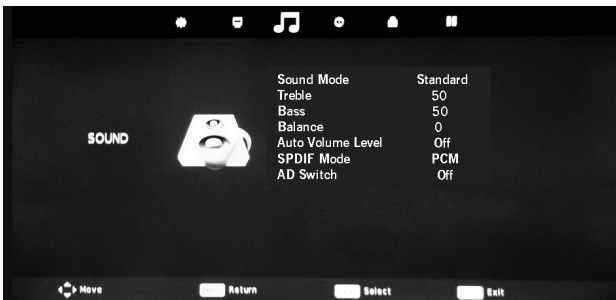

LED COLOR TV

4.4 TIME MENU

✧ Press MENU to display the main menu, and press ◀/▶ to select the Time Menu.

✧ **Clock:** Sets the system time.

✧ **Time Zone:**select time zone

✧ **Sleep Time:** Select the time in minutes.

that you want the TV to shut off automatically after you set the time. Cancel by setting it to Off.

✧ **Auto Standby:** Press to select.

✧ **Osd Timer:** Set display time of OSD.



4.5 LOCK MENU

✧ Press MENU to display the main menu , and press ◀/▶ to select the Lock Menu.

✧ **System Lock:** System lock switch.

✧ **Set Password :** Set the system password lock.

✧ **Channel Lock:** Press Green button to lock or unlock the channel.

✧ **Parental Guidance:** Select the number of age which is suitable for your children.

✧ **Key Lock:**To select Off or On.

✧ **Hotel Mode:**To select Off or On.



LED COLOR TV

4.6 SETUP MENU

- ✧ Press MENU to display the main menu , and press ◀/▶ to select the Option Memu.
- ✧ **Language:** Set the OSD display language.
- ✧ **TT Language:** Press ▼/▲/◀/▶ button to select TT language.
- ✧ Audio Languages/Subtitle Language:Press to select the items.
- ✧ Hearing Impaired:Press to set the Hearing Impaired to “on” or “off”.
- ✧ **PVR File System:** Set the recording file system.
- ✧ **First Time Installation:**Press “▶” or “ok” to enter relevant options including OSD Language and Country.
- ✧ **Reset:** Recall the default setting.
- ✧ **Software Update(USB):** To upgrade the software.
- ✧ **Environment:** Press to set the energy star to "Home Mode" or "Shop Mode".

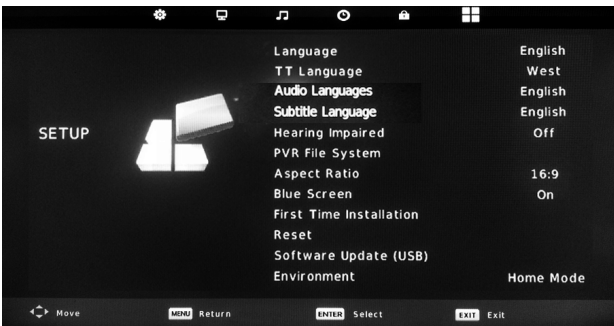

5、MEDIA

The color of the icon means whether your TV has detected a USB memory or not. Blue: Yes; Gray: No;

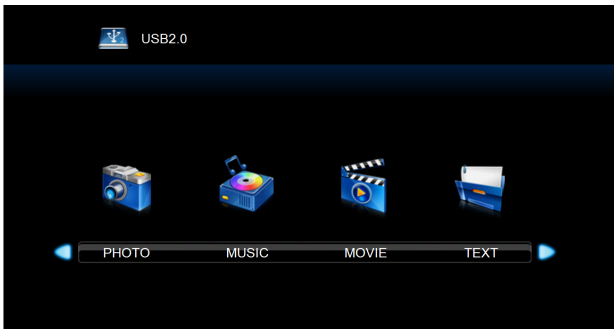

Press ◀/▶ to select Photo/Music/Movie/Text icon and ENTER to enter the USB memory.
For details,

LED COLOR TV

5.1 PHOTO



Select a picture file and press ENTER to view, and it will display all the pictures in the folder automatically. Press ENTER to display the following menu.

PAUSE Press “PAUSE” button to pause the slideshow.

NEXT/PREV . Press “NEXT/PREV.” button to skip to view the photo which are selected the photo.

STOP Press “STOP” button to stop and return.

REPEATALL Press ENTER to select the repeat mode: Repeat 1/ALL/None.

MUSIC Press to play or stop the background music.

PLAYLIST Press to view the list of pictures.

INFO. Press to display the information of the current picture (Resolution/Size/Date/Time)

ROTATE Rotate counterclockwise.

ZOOM IN Zoom the picture in.

ZOOM OUT Zoom the picture out.

MOVE VIEW Zoom out the picture first.Highlight the icon and press ENTER, then press

▼/▲& ◀/▶ to move the picture.

LED COLOR TV

5.2 MUSIC

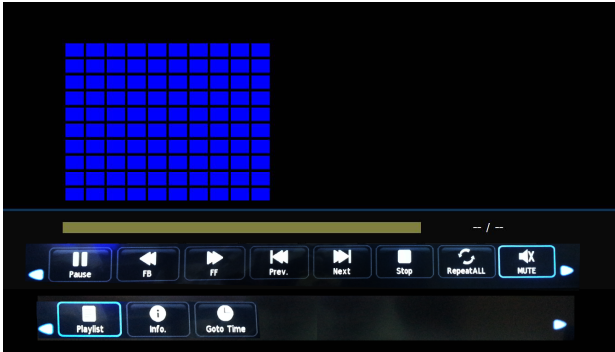

Press ENTER to display the menu.

PLAY Press to play or stop.

FB Press to play slower.

FF Press to play faster.

PREV Press to play the previous song.

NEXT Press to play the next song.

STOP Press to stop and return to folder interface.

REPEAT ALL Press to select the repeat mode: Repeat 1/ALL/None.

MUTE Press to mute.

PLAYLIST select “playlist” to display play list.

INFO. Select “info” to display the music information.

GOTO TIME select “goto time” to setup play time.

LED COLOR TV

5.3 MOVIE

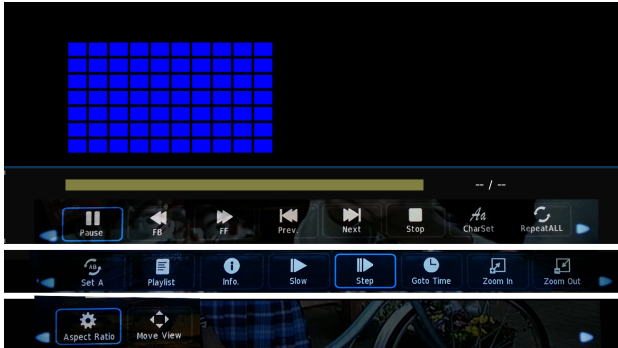

Press ENTER to display the menu.

PLAY/PAUSE Press to play or pause.

FB Press to play slower.

FF Press to play faster.

PREV. Press to play previous movie.

NEXT Press to play next movie.

STOP Press to stop and back to folder interface.

CHARSET Press to set the charset

REPEAT ALL Press to select the repeat mode: Repeat 1/ALL/None.

SET A Select AB mode.

PLAYLIST Press to view the list of pictures.

INFO. Press to display the information of the current movie

SLOW FORWARD slow forward

STEP FORWARD step forward

GOTO TIME select "goto time" to setup play time.

ZOOM IN Zoom the movie in.

ZOOM OUT Zoom the movie out.

ASPECT RADIO Auto/4:3/ 16:9 /Zoom1/Zoom2

MOVE VIEW Zoom in the picture first.Highlight the icon and press ENTER, then press

▼/▲& ◀/▶ to move the movie.

LED COLOR TV

5.4 TEXT

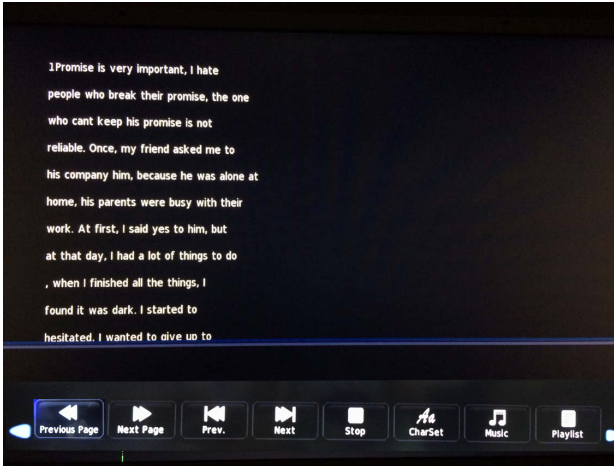

PREV PAGE Press to the previous page

NEXT PAGE Press to the next page.

PREV. Press to play previous text.

NEXT Press to play next text.

STOP Press to stop and back to folder interface.

MUSIC Press to play or stop the background music.

PLAYLIST Press to view the list of texts.

LED COLOR TV

6. Technical Specification

Product Model	32DTV231E	
Screen Size	32" diagonal	
Aspect Ratio	16:9	
Power Supply	AC 100-240V~,50/60Hz	
Power Consumption	60W	
TV System	PAL B/G/D/K I,SECAM B/G D/K DVB-T/T2/C/S/S2(s/s2 option) (There is no DVB-C signal in some Countries or Areas.)	
Audio Output Power (Internal)	8Wx2	
Input Terminal	Antenna Input	x 2 (S2 option)
	USB Input	x 2
	HDMI Input	x 3
	VGA Input	NO
	PC AUDIO Input	NO
	Audio Input (L/R)	x 1(mini)
	Video Input	x 1(mini)
	YPbPr Input	NO
	RJ45 Input	NO
	CI card In	x 1
	SCART In/Output	NO
	DC In (12V)	NO
	CARD SLOT	NO
Output Terminal	Earphone	x 1
	Audio Line Out(L/R)	NO
	Video Output	NO
	Optical	NO
	Coaxial out	x 1
Working Temperature	0°C~40°C	
Working Humidity	20% ~ 80% Non-condensing	

Note:the specification shown above may change without notice for quality improvement.



Manufactured under license from Dolby Laboratories. Dolby, Dolby Audio, and the double-D symbol are trademarks of Dolby Laboratories Licensing Corporation.

LED COLOR TV

7. Supported Signal Modes

A.HDMI Mode

Resolution	Horizontal Frequency (Khz)	Vertical Frequency (Hz)
480p	31.468	59.94
576p	31.25	50.00
720P	45.00	60.00
1080i	33.75	60.00
1080P(1920x1080)	67.50	60.00

-When the signal received by the Display exceeds the allowed range, a warning message will appear on the screen.

-You can confirm the input signal format onscreen.



The terms HDMI, HDMI High-Definition Multimedia Interface, HDMI trade dress and the HDMI Logos are trademarks or registered trademarks of HDMI Licensing Administrator, Inc.

LED COLOR TV

8. Simple Troubleshooting

If the display fails or the performance changes dramatically, check the display in accordance with the following instructions. Remember to check the peripherals to pinpoint the source of the failure.

Symptom	Solution
Power cannot be turned on.(Power indicator does not light.)	-Check that both ends of the power cable are plugged into the socket appropriately and the wall socket is operational
No Input Signal message appears.	-Check that the signal line is connected properly. -Check that the power of the relevant peripherals is turned on. -Check that the Input option that has been selected matches with the input signal.
The remote control does not function properly.	-Check the batteries are not drained.(Use new batteries.) -Check that the remote control is within the operating range. -Check that the remote control is pointed to the remote control window on the display. -Check that there are no obstacles between the remote control and the remote control window.
Flashing spots or stripes appear on the screen.	-Check that there are no emission (Car, HV cable or Neon lamp) or other possible interference sources.
Image colour or quality deteriorates.	-Check that all the video settings are adjusted appropriately, such as brightness, contrast, colour etc. -For more information about video settings, refer to OSD Functions in Chapter 2.
Screen position and size are incorrect.	-Check that the screen position and size is adjusted appropriately.
Image or colour is incorrect.	-Check that the signal line is connected properly. -When connecting to a PC, you can change the resolution of the PC to acquire the correct image. The discrepancy of the PC output signal may affect the display of the image.
Display warning message.	-Check that the input signal line is properly fixed. -Select the correct input signal. -For more information, refer to Supported Signal Modes in Chapter 4.



LED TV UREDAJ
MODEL: 32DTV231E

NAPAJANJE: 100-240V~ 50/60Hz
SNAGA POTROŠNJE: 60W

UPOZORENJE: KAKO BISTE SPREČILI POŽAR I LI ELEKTRIČNI UDAR NE IZLAŽITE OVAJ UREDAJ KIŠI ILI VLAZI, NE POSTAVLJAJTE PREDMETE ISPUJNE TEČNOŠĆU NA I OKO UREDAJA. KABL ZA NAPAJANJE ISKLJUČITE IZ UTIČNICE AKO UREDAJ NE KORISTITE DUŽI VREMENSKI PERIOD. OVAJ UREDAJ PRI RADU KORISTI VISOKI NAPON, NE UKLANJAJTE ZADNJI POKLOPAC. OBRATITE SE KVALIFIKOVANOJ SERVISNOJ SLUŽBI ZA OBAVLJANJE SERVISA

Proizveo: JinPin Electrical Company Ltd.
Zhuhai S.E.Z. No. Building 4,
No. 35, Jiechuan Road,
Hengqi Town, Jinshan District,
Zhuhai City, Guangdong Province, China.

UVOZNIK ZA SRBIJU:
VIMPORT DOO BEOGRAD,
BATAJNIČKI DRUM 9 DEO 10A,
11080 BEOGRAD-ZEMUN, SRBIJA



HDMI

SERVISKI BROJ:



Nadamo se da ste pažljivo pročitali uputstva i da ćete ih se pridržavati.
Za više informacija o FOX uređajima posetite našu internet stranicu:

www.foxelectronics.rs