



UPUTSTVO ZA UPOTREBU

LED TELEVIZORI

Model: 75WOS630E

HDMI

Hvala Vam što ste kupili ovaj uređaj.

FOX LED televizori prepoznaju se po odličnim tehničkim karakteristikama, kao i modernom, funkcionalnom i elegantnom dizajnu. Osim toga konstantna unapređenja u vidu postprodajne

podrške, izuzetno efikasna i rasprostranjena servisna mreža čine da se ponosni vlasnici **FOX televizora** mogu osećati sigurno.

Napravili ste pravi izbor.



U nastavku slede uputstva za upotrebu. Nisu komplikovana, ali ih se morate pridržavati.

SR

VAŽNA BEZBEDONOSNA UPUTSTVA

UPOZORENJE

KAKO BISTE SPREČILI POŽAR ILI ELEKTRIČNI UDAR NEMOJTE KORISTITI PRODUŽNI KABL, DUPLI UTIKAČ ILI DRUGE DODATKE NA UTIČNICI OSIM ONIH KOJI BI MOGLI DA SPREČE IZAZIVANJE STRUJNOG UDARA. KAKO BISTE SPREČILI POŽAR ILI ELEKTRIČNI UDAR NE IZLAŽITE OVAJ UREĐAJ VLAZI ILI KIŠI.

 <p>Ovaj simbol munje u jednakostraničnom trouglu upozorava korisnike na prisustvo opasnog i ne izolovanog napona unutar kućišta proizvoda koji može biti dovoljan da stvori rizik STRUJNOG UDARA</p>	<p>CAUTION</p> <p>RISK OF ELECTRIC SHOCK DO NOT OPEN</p> <p>Upozorenje: Da biste smanjili rizik od strujnog udara nemojte skidati poklopac (ili zadnju stranu). Unutra nema delova koje korisnik može sam da zameni. Za obavljanje servisa zatražite pomoć kvalifikovanog osoblja.</p>	 <p>Znak uzvika unutar jednakostraničnog trougla u ovom uputstvu upozorava korisnika na prisustvo važnih instrukcija za rad i održavanje (servisiranje) uređaja.</p>
--	---	---

Ovaj aparat ne treba izlagati vodi, a predmete ispunjene tečnošću poput vaza ne treba da budu postavljeni na i oko uređaja.

OPREZ

Postoji opasnost od eksplozije ako se baterija nepropisno zameni.

Zamenite postojeću sa samo odgovarajućom vrstom baterije.

Nemojte izlagati bateriju direktnoj sunčevoj svetlosti ili bilo kojem drugom izvoru toplote.

Obezbedite pravilno odlaganje istrošenih baterija.

Ostavite lako dostupnim mesto gde je utikač ili nastavak za prekid napajanja.

Da biste smanjili rizik od strujnog udara, ne obavljajte bilo kakvo servisiranje osim onih koje se pominju u ovom uputstvu.

VAŽNE INFORMACIJE

Ako televizor nije postavljen na dovoljno stabilnom mestu, može postojati potencijalna opasnost od pada.

Mnoge povrede, posebno dečije, mogu se izbeći primenom jednostavnih mera opreza kao što su:

Korišćenje elemenata ili stalaka koje je preporučio proizvođač televizora.

Korišćenje samo onog nameštaja koji može sigurno izdržati uređaj.

Obezbeđivanje uređaja tako da ne prelazi ivicu nameštaja.

Nemojte postavljati TV na visok nameštaj (na primer, ormare ili police) bez prethodnog pričvršćivanja kako nameštaja tako i uređaja na odgovarajuću površinu.

Ne pokrivajte televizor krpom i ne stavljajte drugi materijal između televizora i nameštaja na kom on stoji.



Sigurna instalacija

Koristite pojas za fiksiranje televizora kako bi sprečili uređaj od pada unapred.



1. **Pročitajte uputstva**- Sve napomene o sigurnosti i načinu rada treba pročitati pre uključivanja aparata.
2. **Sačuvajte uputstva** – Uputstva za sigurnost i uputstvo za upotrebu treba da se sačuvaju za buduće potrebe.
3. **Imajte u vidu Upozorenja** – Treba se pridržavati svih upozorenja na aparatu i svih uputstava za upotrebu.
4. **Pratite uputstva**- Treba pratiti sva uputstva.



5. **Voda i vlažnost** – Aparat ne treba koristiti u blizini vode.
6. **Nosač i postolje** – Aparat treba koristiti samo sa nosačem ili postoljem koje preporučuje proizvođač
7. **Montaža na zid ili plafon** – Aparat treba da se montira na zid ili plafon samo po preporuci proizvođača.
8. **Ventilacija** – Aparat treba da bude dobro postavljen, tako da lokacija ili pozicija aparata ne ometaju njegovo provetravanje.
9. **Toplota** – Ovaj aparat treba postaviti dalje od izvora toplote kao što su radijatori i peći.
10. **Napajanje** - Aparat treba povezati samo na napajanje kao što je opisano u uputstvima za upotrebu ili onako kako je naznačeno na uređaju.
11. **Uzemljenje ili polarizacija** – Treba preduzeti mere predostrožnosti.
12. **Zaštita kabla za napajanje** – Naponski kabl treba da bude usmeren tako da je malo verovatno da se može gaziti, priklješiti stvarima na njemu i njegovom kraju.
13. **Čišćenje** – Aparat bi trebalo čistiti samo po preporuci proizvođača.
14. Napajanje spoljne antene treba da se nalazi daleko od dalekovoda.
15. **Uzemljenje spoljne antene** – Ako je spoljna antena povezana na prijemnik, antenski sistem mora biti uzemljen kako bi se obezbedila zaštita od naponskog i izvornog statičkog elektriciteta.
16. **Kada ga dugo ne koristite** – napajanje uređaja trebalo bi da bude isključeno iz utičnice kada se ne koristi duži vremenski period.
17. **Upad predmeta i tečnosti** – Treba paziti da predmeti ne upadnu, a tečnost ne prospe u kućište kroz otvore.
18. **Kada je potreban servis** – Aparat treba da servisira kvalifikovano servisno osoblje kada su:
 - Kabal za struju ili utikač oštećeni.
 - Kada predmeti upadnu ili kada se tečnost prolije po uređaju
 - Kada je aparat izložen kiši
 - Kada aparat ne radi normalno ili pokazuje značajnu promenu u radu.
19. Ventilacioni otvori ne bi trebalo da budu pokriveni predmetima, kao sto su novine, tkanine, zavese itd.
20. Izvore otvorenog plamena, kao sto su upaljene sveće, ne bi trebalo da stoje na aparatu
21. Aparat će biti povezan sa mrežnom utičnicom sa zaštitnim uzemljenjem. Utičnica ili nastavak za prekid napajanja trebaju da budu lako dostupni.

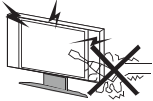

UPOZORENJE

Visok napon se koristi u napajanju ovog uređaja. Ne uklanjajte zadnji poklopac. Obratite se kvalifikovanoj osobi za obavljanje servisa.

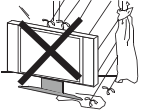

UPOZORENJE

Da biste sprečili požar ili strujni udar, nemojte izlagati uređaj kiši ili vlazi.



UPOZORENJE

Nemojte ispuštati i gurati predmete u kućište TV-a ili u otvore. Nikada nemojte prosipati tečnost na TV prijemnik.

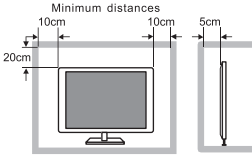

OPREZ

Ako televizor treba da se ugradi u zatvoreni odeljak ili na sličan način, morate se pridržavati dela uputstva o minimalnim udaljenostima. Toplota može smanjiti životni vek televizora, a takođe može biti povećan rizik od požara.



OPREZ

Nikada nemojte da stanete ili se oslonite ili gurnete uređaj ili stalak na kom se uređaj nalazi. Treba obratiti posebnu pažnju na decu.

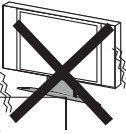

OPREZ

Ne stavljajte glavnu jedinicu na nestabilno postolje, policu ili sto. Usled pada može doći do ozbiljne povrede lica ili štete na televizoru.

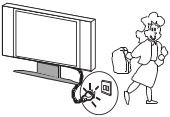

OPREZ

Kada se proizvod ne koristi duži vremenski period, preporučljivo je da isključite mrežni kabl iz utičnice .

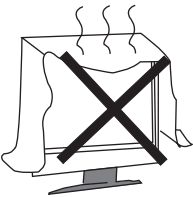

OPREZ

Izbegavajte izlaganje glavne jedinice direktnom suncu i drugim izvorima toplote. Ne postavljajte televizor na druge proizvode koji emituju toplotu. Na primer: Video uređaj, audio pojačala. Ne blokiraj otvore za ventilaciju u zadnjem poklopcu. Ventilacija je od suštinskog značaja za sprečavanje električnih kvarova. Ne stavljajte kabl za napajanje ispod glavne jedinice.



OPREZ

Panel (ekran) koji se koristi u ovom proizvodu napravljen je od stakla. Može se slomiti padom uređaja ili nasilnim udarcem. Pojedinci treba oprezno da rade sa razbijenim staklom ekrana.



- Postavite TV na stabilnu, ravnu površinu, ostavljajući najmanje 10 cm oko njega i 30 cm između vrha seta i zida ili ormarića. Da biste sprečili da se televizor prevrne kada ga gurnete, postavite ga blizu zida. Umesto da držite gornju stranu televizora kada ga okrećete, trebalo bi da držite donju stranu.

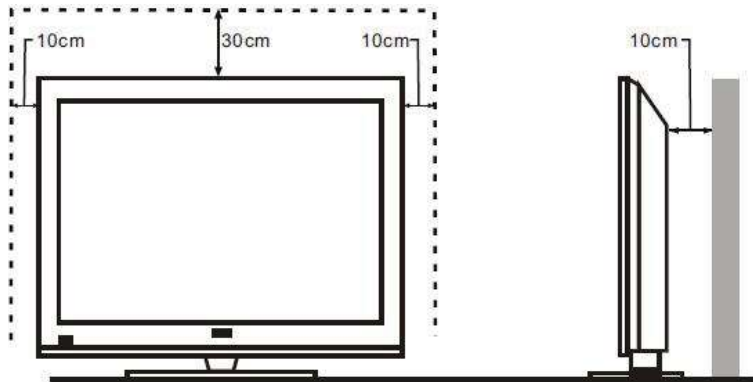

- Izbegavajte rukovanje televizorom samo jednom rukom kada ga podižete; umesto toga, koristite dve ruke.

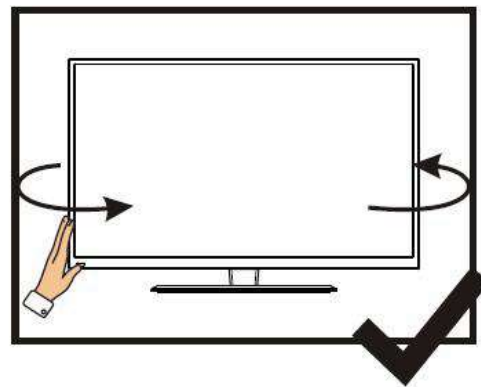
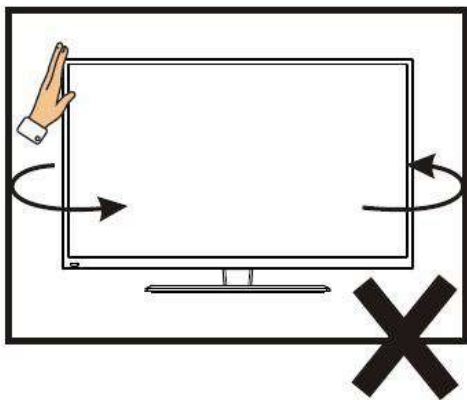

- Izbegavajte rukovanje televizorom samo jednom rukom kada ga podižete; umesto toga, koristite dve ruke.

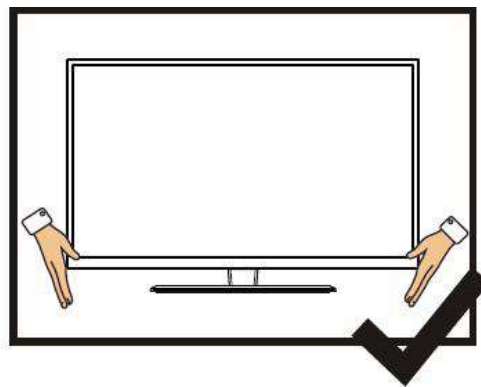
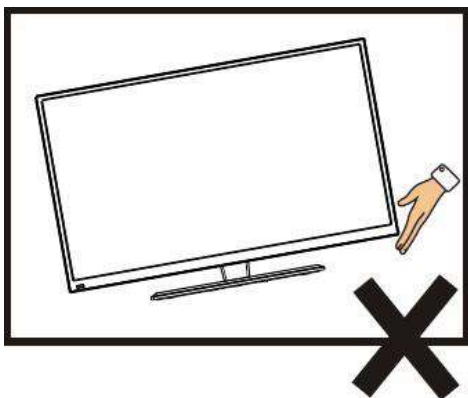

SADRŽAJ

1. Priključivanje i priprema TV-a	2
1.1 Dodatna oprema	2
1.2 Instalacija postolja	2
1.3 Tasteri i interfejsi	3
1.4 Daljinsko upravljanje	4
1.5 Instalacija baterija	5
2. Osnovna operacija	5
2.1 Uključivanje/isključivanje (opciono)	5
2.2 Podešavanje režima pripravnosti	5
3. Boot Vizard	6
4. Uživajte TV-u uživo	7
5. Prvi koraci sa vebOS TV-om	8
6. Kako se koristi TV	13
7. UŽIVANJE PRODAVNICA SADRŽAJA	15
8. POVEZIVANJE SPOLJNIH UREĐAJA	19
9. ISKORISTITE NAJBOLJE OD PAMETNE TV	21
10. PODEŠAVANJA	21
11. Tehnička specifikacija	39
12. Podržani režimi signala	40
13. Jednostavno otklanjanje poteškoća	41

FOX LED TV

1 Priključivanje i priprema TV-a

1.1 Dodatna oprema

- ✧ Uputstvo za korišćenje
- ✧ Daljinsko upravljanje
- ✧ Baterija (UM-4/R03P/AAA)
- ✧ Komplet za montiranje na zid (unapred montiran) (opciono)

1.2 Instalacija postolja

(Molimo pogledajte stvarni objekat za detalje o fizičkoj strukturi.)

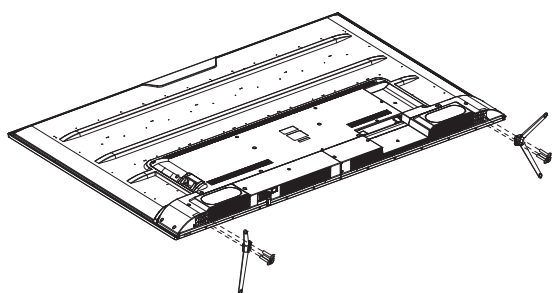

- 1) Postavite TV na mekanu tkaninu ili meke jastuke na sto tako da prednja ploča bude okrenuta nadole.
- 2) Stavite postolje u donju utičnicu televizora.
- 3) Zašrafite utičnice sa zavrtnjima na mestu, a zatim ih zategnite.

FOX LED TV

1.3 Tasteri i interfejsi

Stvarne stavke se koriste kao standard u dizajnu i specifikaciji.

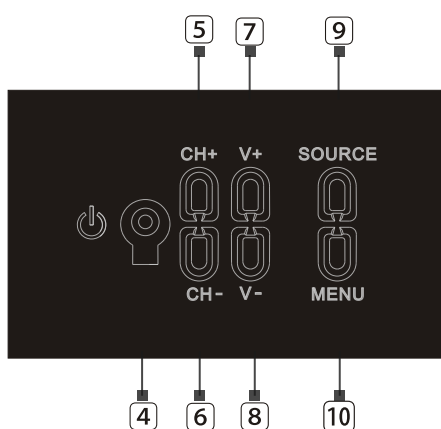
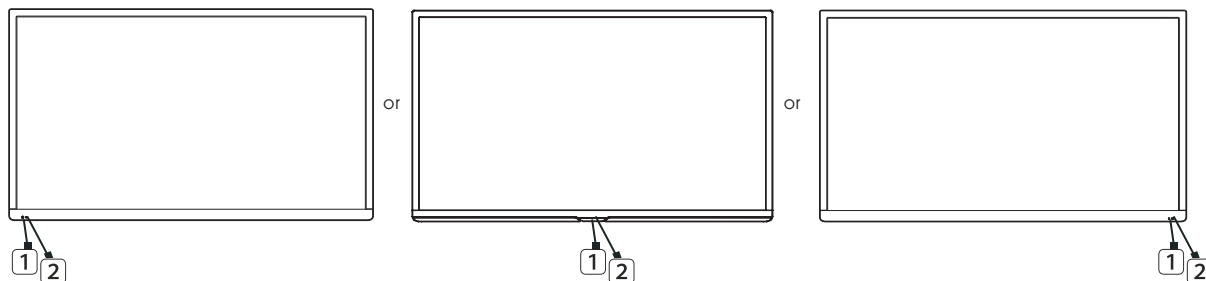

1. Prozor daljinskog senzora
2. Indikator snage
3. Govornik
4. Taster pripravnosti
5. CH "+"dugme
6. CH "-"dugme
7. Volume "+"dugme
8. Volume "-" dugme
9. SOURCE dugme
10. Menu dugme
11. ULAZ ZA NAPAJANJE

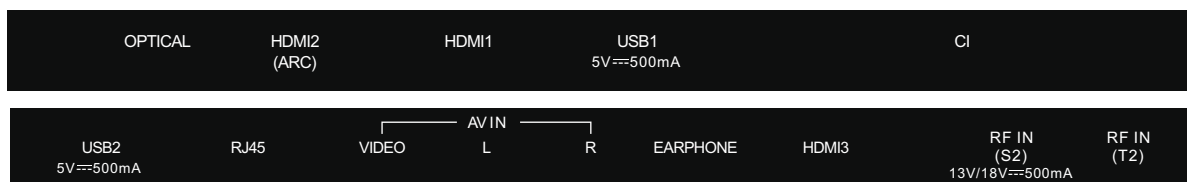
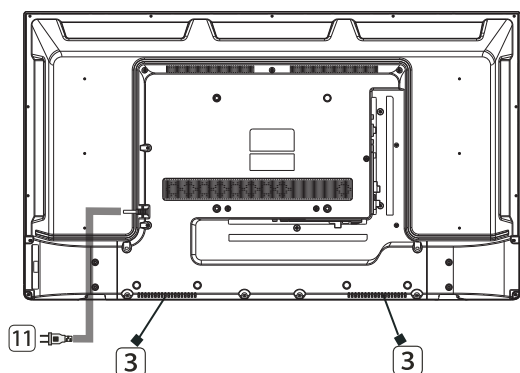

FOX LED TV

1.4 Daljinski upravljač

(Ovde je samo skica, molim u naturi)



Molimo vas da dugo pritisnete dugmad počevši od #. (izdrži duže od sekunde).

POWER: UKLJUČENO/ISKLJUČENO.

(STB POWER) Možete da uključite/isključite snagu set-top box dekodera.

0-9: Ključ za izbor brojeva.

0#: Pojavio se ekran za brzo uređivanje programi **BRZI PRISTUP.**

LIST: Provera sačuvanih programi.

... : On prikazuje dodatnu dugmad na daljinskom upravljaču.

...#: Audibly opisuje sadržaj ekrana.

: Podešava nivo jačine zvuka.

: Potvrdite izbor u polju za potvrpivanje zvuka sa TV-a.

: Unesite meni pristupačnosti.

: Program možete promeniti.

Ispitajte predloženi sadržaj. (U zavisnosti od zemlje, usluge preporuke mogu, ali i ne mora biti ponuđene.)

: Da biste koristili funkciju prepoznavanja govora, pritisnite i držite dugme dok govorite.

: Prikazuje meni Početak.

: Prikazuje listu koja je prethodno korišćena.

: Unosi meni "Brze postavke".

: Unosi meni "Sve postavke".

Wheel (OK) : Da biste izabrali meni, pritisnite dugme Točak u centru.

Dugme na točkovima se koristi za promenu kanala.

(up/down/left/right) Pomerajte se po meniju pritiskom na dugme nagore, nadole, levo ili desno. Ako pritisnete dugme dok je pokazivač aktivan, kursor će nestati sa ekrana i Magični daljinski upravljač će se ponašati kao svaki drugi daljinski upravljač. Protresite magični daljinski upravljač levo i desno da ponovo prikažete pokazivač na ekranu.

: Premeštanje na prethodni korak

: Zatvara meni.

: Možete proveriti program.

NETFLIX : idi na Netfliks.

: Bira izvor unosa.

: Ulazimo u kućnu kontrolnu tablu.

: idite na udarni video.

: Oni pristupaju posebnim funkcijama u nekim menijima.

MOVIES: Pretraži filmove.

: Igra.

: Pauziraj.

FOX LED TV

1.5 Instalacija baterija

(Molim vas da prevladate, ovo je samo skica.)

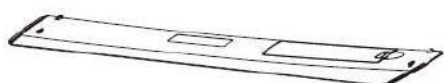

- 1 Zadnji poklopac daljinskog upravljača treba da bude otvoren.
- 2 Stavite dve 7# (AAA) 1.5V baterije u sistem.
Uverite se da su baterije pravilno polarizovane.
- 3 Pokrijte zadnji poklopac.

Izvadite baterije iz daljinskog upravljača ako ga neko vreme nije koristio.

Izvršite sledeće provere ako daljinski upravljač ne funkcioniše ispravno.

- Proverite da li je TV u programu.
- Proverite da li je polaritet baterija odgovarajući.
- Proverite da li baterije nisu iscrpljene.
- Uverite se da je napajanje u ispravnom stanju ili da je kabl za napajanje pravilno povezan.
- Uverite se da u blizini nema neobičnih neonskih ili fluorescentnih svetla.

2 Osnovna operacija

2.1 Uključivanje/isključivanje (opciono)

- Povežite kabl za napajanje sa **AC ulazni**. Utaknite kabl za napajanje u odgovarajuću utičnicu.
- Pritisnite **Prekidač** da uključite TV, zatim pritisnite **Napajanje** dugme za uključivanje jedinice.
- Pritisnite **Prekidač** ponovo da isključite TV.

Beleška: Nemojte odmah ponovo da otvarate prekidač za napajanje nakon što isključite TV; umesto toga, sačekajte jedan minut pre nego što ponovo otvorite prekidač za napajanje.

2.2 Podešavanje režima pripravnosti

- Pritisnite (⏻) dugme da biste uključili jedinicu.
- Pritisnite (⏻) dugme ponovo da vratite ekran u režim pripravnosti. Indikator napajanja svetli crveno.
- Uverite se da vaš TV nije ostavljen u režimu pripravnosti duži vremenski period.

2.3 Izbor režima unosa

Ovaj set sadrži više modova izvora signala; pritisnite dugme **Source** više puta da biste izabrali izvor signala.

FOX LED TV

3. Boot Wizard

Na daljinskom upravljaču pritisnite dugme OK (točak).



Potvrdite podešavanja jezika i lokacije.

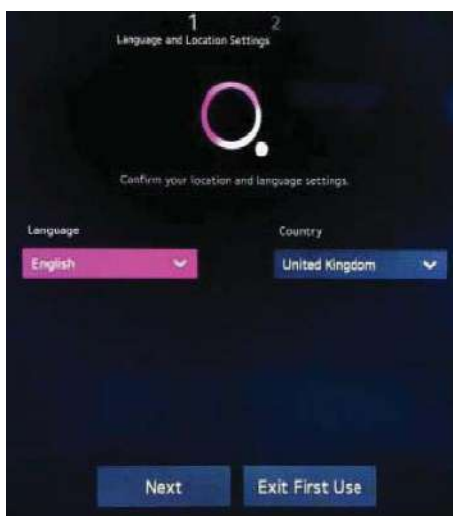

Uđite u TV režim pritiskom na dugme Ekit Prva upotreba.

Kliknite na dugme Dalje. Nastavite sa čarobnjakom da biste podesili mrežnu vezu i druge aktivnosti.

4. Uživajte TV-u uživo

Izvučite maksimum iz menija uživo

Korišćenje menija uživo

Kada gledate TV emisije, lako možete koristiti relevantne funkcije. Na daljinskom upravljaču pritisnite dugme LIST.

Alternativno, na daljinskom upravljaču pritisnite dugme Točak (OK) i izaberite Programi.

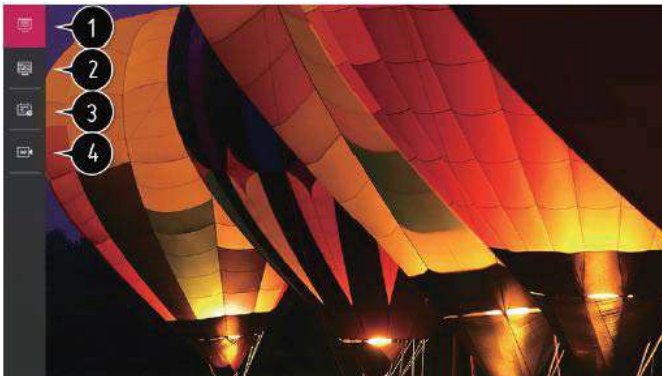

1. Programi: Pogledajte listu emitovanih stavki koje se trenutno emituju.
2. Vodič : Programi i njihovi rasporedi dostupni su za gledanje.
Da biste videli detalje, kliknite na Uživajte TV-u uživo → Vodič za gledanje u Korisničkom vodiču.
3. TV raspored: Možete da unesete vreme i datum programi da biste organizovali njegovo gledanje ili snimanje u to vreme.
Da biste videli detalje, kliknite na Uživajte TV-u uživo→ Korišćenje TV rasporeda u korisničkom vodiču.
4. Snimci : Možete slušati i gledati snimke sačuvane na uređaju za skladištenje.
Da biste videli detalje, kliknite na Uživajte TV-u uživo → Reprodukција snimljenih TV programi u korisničkom vodiču.
Samo kada je priključen spoljni uređaj za skladištenje i snimljeni video se može videti, opcija se prikazuje.
Programi prikazani na listi programi su izbor programi koji daje provajder servisa emitovanja. Kao rezultat toga, ako je programska konfiguracija provajdera servisa emitovanja promenjena bez upozorenja, programi prikazani na listi programi mogu se razlikovati od stvarnih TV programi.
Pošto informacije prikazane na listi programi potiču od spoljnih dobavljača elektronskog programskog vodiča (EPG), one se mogu razlikovati od stvarnih TV programi.
Da biste dobili standardnu uslugu emitovanja uživo, morate da dovršite podešavanja mreže, regiona i automatskog programi.
Stavke koje se mogu konfigurirati se razlikuju u zavisnosti od modela

FOX LED TV

5. Prvi koraci sa vebOS TV-om

Početna stranica priručnik

Korišćenje početne funkcije vebOS TV-a

Možete otvoriti početni ekran pritiskom na  dugme na daljinskom upravljaču.

Često korišćene aplikacije možete da postavite na jedan ekran i da prelazite između njih u bilo kom trenutku.



1. Pokrenite pretragu.

Kliknite na Uživanje u pretraživanju sadržaja prodavnice sadržaja u korisničkom vodiču da biste videli više informacija.

2. Vratite se na početnu kontrolnu tablu.

Možete odabrati ili kontrolisati povezani uređaj (pametni telefon, eksterni uređaj, kućni IoT uređaji, itd.).

Pogledajte Povezivanje spoljnih uređaja pomoću kućne kontrolne table u Uputstvu za korisnike za dodatne informacije.

3. Prebacite na najnoviji korišćeni TV ulaz.

4. Idite na najskorije korišćenu aplikaciju.

Dugo pritisnite  dugme na daljinskom upravljaču ili fokusiranje na Nedavno.

Na listi ponuđenoj u oblasti Pregled na vrhu, možete otvoriti ili zatvoriti prethodno korišćenu aplikaciju.



5. Aplikacije koje ste instalirali na TV-u mogu se pokretati, premeštati i brisati.

Obratite mnogo pažnje na svaku oblast aplikacije. Pregled je dostupan na vrhu.

Bez otvaranja aplikacije, možete da pregledate ili koristite korisne funkcije svake aplikacije i predloženi materijal u pregledu.

Neke aplikacije možda ne nude pregled.

Kada se TV uključi, početni ekran će se odmah prikazati. Ako ne želite da se

prikaže početni ekran, podesite automatsko pokretanje Početna od  →  → Opšte → Početna podešavanja kao Isključeno.

Pristup sadržajima i uslugama na uređaju, kao i njihova dostupnost, podložni su promeni u bilo kom trenutku i bez prethodnog obaveštenja.

FOX LED TV

Početak rada sa vebOS TV-om

Upravljanje Početna stranica

Upravljanje vebOS TV Početna stranica

Možete da pregledate listu svih aplikacija koje su sada pokrenute na vašem TV-u, da ih pomerate ili da ih se rešite.

1. Pritisnite i držite dugme Točak (OK) na daljinskom upravljaču dok birate aplikaciju koju želite da ažurirate.

Kao rezultat toga, biće omogućen režim uređivanja aplikacije.

Alternativno, možete odabrati dugme za režim uređivanja u gornjem desnom uglu početne liste da biste pristupili režimu za uređivanje aplikacije.

2. Idite na lokaciju i pritisnite dugme Točak (OK) da premestite aplikaciju tamo.

Izaberite ikonu App Izbrisi koja se nalazi iznad aplikacije da biste je uklonili.

Pre nego što napustite režim za uređivanje, slobodni ste da premestite i izbrisate onoliko aplikacija koliko želite.

Takođe možete da pomerate aplikacije pomoću ◀▶ dugme na daljinskom upravljaču.

3. Da biste izašli iz režima za uređivanje aplikacije nakon završetka uređivanja, kliknite na dugme Zatvori u gornjem desnom uglu.

Ugrađena TV aplikacija se ne može promeniti.



1. Na osnovu vašeg kumulativnog ponašanja korišćenja aplikacije, lista aplikacija se može automatski sortirati prema najčešće korišćenim.

2. Vaš omiljeni video servisni program se može dodati na listu.

Kada je mreža povezana, ova funkcija je dostupna samo.

Možda postoje modeli koji nisu podržani.

Priprema za TV uživo

1. Povežite TV sa antenom za emitovanje.

Umesto da koristite antenu, možete da povežete deo aparata koji može da prima emisije, kao što je postavljanje vrha bok.

Pokreni ⚙️ → ⓘ Veza → Podešavanja veze uređaja → Univerzalna podešavanja kontrole.

2. Pokrenite ⚙️ → ⓘ → programi Podešavanje programi (Podešavanje programi i podešavanja) automatsko podešavanje.

Pronalazi i dodaje samo programe koji se trenutno emituju.

Pogledajte odeljak Rešavanje problema u Uputstvu za korisnike ako vam je potrebna pomoć da rešite problem sa ovom funkcijom.

Početak rada sa vebOS TV-om

Povezivanje na mrežu

Povezivanje na mrežu

Možete da koristite brojne usluge, uključujući onlajn sadržaj i aplikacije, ako postavite mrežna podešavanja.



Podešavanje žičane mreže

1. Pomoću LAN kabla spojite LAN port rutera sa LAN portom televizora.

Potrebno je prvo povezati ruter na internet.

Kada povežete TV na mrežu pomoću LAN kabla, TV se odmah pridružuje mreži ako ruter podržava DHCP.

Ako mreža nije automatski povezana

2. Pritisnite  dugme na daljinskom upravljaču.
3. Izaberite  → Veza → Podešavanja mrežne veze

Žičana veza (Ethernet).

Da biste videli detalje, kliknite na Podešavanja → Veza → Podešavanja mrežne veze u Korisničkom vodiču

Podešavanje bežične mreže

1. Napajanje rutera povezanog na Internet bi trebalo da bude uključeno.
2. Na daljinskom upravljaču kliknite na dugme Podešavanja.
3. Izaberite ikonu Sva podešavanja → Veza → Mreža → Podešavanja veze → Vi-Fi veza.
4. Lista mreža koje su otvorene za povezivanje se prikazuje nakon što se pretraga mreže završi.
5. Izaberite mrežu za pridruživanje.

Unesite lozinku rutera ako je zaštićena lozinkom ako je vaš bežični LAN ruter.

Da biste videli detalje, kliknite na Podešavanja → Veza → Podešavanja mrežne veze u Korisničkom vodiču.

Povezivanje na mrežu

Upozorenja o mrežnim podešavanjima

1. Koristite uobičajenu LAN žicu (povežite se na Cat7 ili noviji sa RJ45 konektorom, 10 Base-T ili 100 Base TKS LAN portom).
2. Neki problemi sa mrežnom vezom mogu se rešiti ponovnim pokretanjem modema. Da biste rešili problem, isključite napajanje, isključite ga i ponovo ga uključite, a zatim ga ponovo uključite.
3. Bilo koji problemi sa mrežnom vezom ili kvarovi, kvarovi ili greške uzrokovani mrežnom vezom nisu greška proizvođača.
4. Za kvar mrežne veze mogu biti krivi mrežne konfiguracije ili provajder Internet usluga.
5. DSL modem je neophodan za DSL uslugu, dok je kablovski modem potreban za kablovsku uslugu. U zavisnosti od uslova ugovora sa provajderom Internet usluga, možda neće biti moguće koristiti konfiguraciju TV mreže zbog ograničenog broja mrežnih veza koje mogu biti dostupne. (Samo PC koji je već povezan može se koristiti ako ugovor zabranjuje korišćenje više od jednog uređaja po liniji.)
6. Drugi uređaji koji koriste 2,4 GHz mogu izazvati smetnje u bežičnoj mreži (bežični telefon, Bluetooth uređaj ili mikrotalasna pećnica). Iako su smetnje moguće i na opsegu od 5 GHz, manje je verovatno da će se desiti.
7. Usluga bežične mreže može da radi sporo zbog bežičnog okruženja.
Nepotreban saobraćaj na nekim uređajima može biti rezultat nemogućnosti prekida veze sa svim lokalnim kućnim mrežama. Da bi se povezao na AP (pristupnu tačku), uređaj mora da podržava bežične veze i da ima omogućenu mogućnost bežične veze. Da biste proverili da li su bežične veze dostupne na pristupnoj tački, kontaktirajte provajdera servisa.
8. Proverite SSID i bezbednosna podešavanja pristupne tačke. Za informacije o SSID-u i bezbednosnim postavkama pristupne tačke pogledajte odgovarajuću dokumentaciju.
9. Televizor može da radi sporo ili nepravilno ako je mrežna oprema (ožičeni/bežični razdelnik linija, čvorište) pogrešno konfigurisana. Pravilno instalirajte hardver prateći relevantnu dokumentaciju i mrežu.
10. U zavisnosti od proizvođača pristupne tačke, tehnika povezivanja se može promeniti.
11. Pogledajte odeljak Rešavanje problema u Uputstvu za korisnike da biste pronašli rešenje za problem koji uključuje ovu funkciju.

Početak rada sa vebOS TV-om

Upravljanje vašim LG nalogom

Kreiranje LG naloga

Koristeći svoju adresu e-pošte, možete otvoriti novi LG nalog u Upravljanju nalogom.

ID i lozinka naloga spoljne usluge takođe se mogu koristiti za kreiranje i pristup LG nalogu.

Pritisnite  dugme na daljinskom upravljaču.

Izaberite  → Opšte → Upravljanje nalogom → Prijavite se na LG nalog.

Izaberite Kreiraj nalog. Pročitajte uslove korišćenja usluge i prihvatite ih.

Unesite svoj ID i lozinku. Vaša adresa e-pošte mora da služi kao vaš ID.

Unesite datum rođenja.

Link za verifikaciju se šalje e-poštom na navedenu adresu e-pošte ako izaberete OK. Završite verifikaciju e-pošte pre isteka roka.

Možete se prijaviti koristeći detalje ovog naloga ako je verifikacija e-pošte uspešna i ako je kreiran LG nalog.

Možda postoje modeli koji nisu podržani.

Da biste napravili nalog, morate imati internet vezu.

U zavisnosti od nacije, mogu biti potrebni različiti detalji.

U zavisnosti od vašeg uzrasta, može vam biti zabranjeno korišćenje usluge.

Pogledajte odeljak Rešavanje problema u Uputstvu za korisnike ako vam je potrebna pomoć da rešite problem sa ovom funkcijom.

Upravljanje vašim LG nalogom

Možete upravljati informacijama svog LG naloga.

Pritisnite  dugme na daljinskom upravljaču.

Pomeriti u  → Opšte → Upravljanje nalogom da biste se prijavili.

Lična informacija

Možete da pristupite i promenite informacije o svom nalogu dok ste prijavljeni.

Možete pritisnuti Uredi da izmenite svoje lične podatke ili promenite lozinku.

Možda postoje modeli koji nisu podržani.

FOX LED TV



6. Kako se koristi TV

Povezivanje sa SIMPLINK (HDMI-CEC)

Korišćenje SIMPLINK

Možete jednostavno da kontrolirate brojne uređaje, kao što su soundbar ili postavljanje vrha bok koji su povezani sa TV-om preko HDMI-ja, sa samo jednim daljinskim upravljačem.

Moguće je povezati i koristiti tri uređaja odjednom.

1. Koristite HDMI kabl da povežete SIMPLINK HDMI izlazni port sa HDMI IN portom televizora.
2. Pritisnite  dugme na daljinskom upravljaču.
3. Izaberite  → Veza → Podešavanja veze uređaja..
4. Uključite SIMPLINK (HDMI-CEC).
5. Postavite opcije automatske sinhronizacije napajanja na Uključeno ili Isključeno. (Ako je automatska sinhronizacija napajanja omogućena, uključenje uređaja povezanog sa SIMPLINK takođe uključuje napajanje televizora. Uređaj će se takođe isključiti kada je TV isključen.)
6. Aktivirajte upareni uređaj. Ulaz će se promeniti kada se TV automatski poveže sa gadžetom.

Kliknite na dugme Ulaz ako uređaj nije automatski povezan sa TV-om.

Ovu funkciju mogu da koriste samo uređaji sa logotipom SIMPLINK. Proverite da li spoljni uređaj ima logotip SIMPLINK.

Bilo koji proizvod osim navedenih može dovesti do problema sa radom.

Za korišćenje Simplink-a potreban je brzi HDMI kabl sa funkcijom CEC (Consumer Electronics Control). Pin 13 na HDMI kablu velike brzine omogućava komunikaciju između uređaja.

Podesite SIMPLINK (HDMI-CEC) na Uključeno ako želite da šaljete zvuk na spoljnu audio opremu koja je povezana preko HDMI kabla.

Kako se koristi TV

Podržane funkcije SIMPLINK-a

Trenutno Plai

Kada je multimedijalni uređaj uključen, možete odmah da gledate njegov sadržaj na TV-u, a da ne morate ništa da radite.

Korišćenje daljinskog upravljača za TV za upravljanje uređajima

Omogućava korisniku da vidi materijal na multimedijalnim uređajima kontrolišući ih pomoću daljinskog upravljača za TV. Funkcija pokazivača Magic daljinskog upravljača može biti ograničena.

Isključeno glavno napajanje

Uređaji povezani sa vašim TV-om preko SIMPLINK-a će se takođe isključiti ako je automatska sinhronizacija napajanja podešena na Uključeno u podešavanjima veze uređaja i vaš TV je isključen.

Samo odabrani uređaji imaju pristup ovoj funkciji.

Uključeno glavno napajanje

Kada je uređaj povezan sa SIMPLINK-om uključen, TV će se takođe uključiti ako je automatska sinhronizacija napajanja omogućena u podešavanjima veze uređaja.

Automatska sinhronizacija napajanja se ne može postaviti na Uključeno ako je SIMPLINK (HDMI-CEC) podešen na Isključeno.

Možda postoje modeli koji nisu podržani.

Prečice za Pristupačnost

Prečice za Pristupačnost

Možete zaobići odeljak Napredna podešavanja i otići direktno na Pristupačnost.

Dugme MUTE na vašem daljinskom upravljaču treba da se pritisne i zadrži.

Visoki kontrast, sivi tonovi, obrnute boje itd. se mogu podesiti.

7. UŽIVANJE PRODAVNICA SADRŽAJA

Početna stranica priručnik

Korišćenje prodavnice sadržaja

Aplikacije iz raznih oblasti, uključujući obrazovanje, zabavu, način života, vesti i igre, dostupne su za preuzimanje i korišćenje.

Na daljinskom upravljaču pritisnite dugme HOME.

Pokrenite Prodavnicu sadržaja.

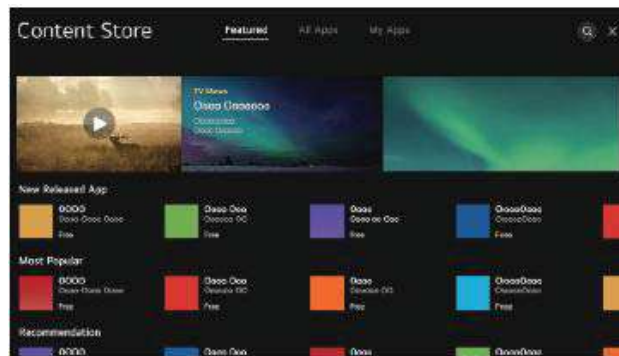

Ponuđeni sadržaji mogu varirati ili neke funkcionalnosti mogu biti ograničene u zavisnosti od modela. Kada ga koriste deca, budite oprezni. Ovaj proizvod može deci omogućiti pristup nepoželjnom veb sadržaju. Ograničavanjem pristupa određenim aplikacijama možete filtrirati neprikladan internet sadržaj.

Konfigurirajte podešavanja u   → Opšte → Bezbednost → Zaključavanje aplikacija.

Instaliranje aplikacija

Na televizoru možete da preuzmete razne aplikacije iz prodavnice sadržaja.

1. Pritisnite  dugme na daljinskom upravljaču.
2. Pokrenite Prodavnicu sadržaja.
3. U gornjem uglu ekrana izaberite kategoriju Sve aplikacije.

Biće prikazana lista dostupnih aplikacija u izabranoj kategoriji.

4. Izaberite aplikaciju sa liste i podesite je.
5. Nakon što pročitate opis aplikacije, kliknite na Instaliraj.
6. Nakon što je instalacija završena, možete odmah pokrenuti aplikaciju.

Dostupne kategorije mogu se promeniti u zavisnosti od nacije ili nivoa usluge.

Možete da instalirate aplikacije tako što ćete povezati spoljni memorijski uređaj ako skladišni prostor na TV-u nije dovoljan.

Neki USB uređaji za skladištenje možda nisu kompatibilni sa njima ili rade loše.

Nije dozvoljeno korišćenje aplikacija sa drugih televizora na USB stickovima.

Možete ukloniti preuzete programe iz Mojih aplikacija.

Preporuka sadržaja

Na osnovu programi koji gledate ili vaših navika gledanja TV-a, možete primati preporuke sadržaja.

Da biste normalno koristili funkciju preporuke ako gledate TV sa prijemnikom, morate da završite konfiguraciju univerzalnog daljinskog upravljača. Za više informacija pogledajte Kako se koristi TV→ Korišćenje univerzalnog daljinskog upravljača u Uputstvu za korisnike.

Pritisnite  dugme na daljinskom upravljaču.

Pokrenite pretragu

Možda postoje modeli koji nisu podržani.

Da biste koristili funkciju preporuke, prvo se morate povezati na mrežu.

Pošto se usluge podrške razlikuju od zemlje do zemlje, predlozi se mogu razlikovati.

U zavisnosti od materijala u programu koji gledate, lista preporuka može biti manje relevantna ili irelevantna.

Potražite sadržaj

Potražite sadržaj

Možete da dobijete preporuke za sadržaj na osnovu svojih navika gledanja ili da ga sami potražite.

Pritisnite  dugme na daljinskom upravljaču.

Pokrenite pretragu.

Koristeći potrebne fraze za pretragu, potražite različite sadržaje i informacije.

Povratak na prethodni ekran.

Ova funkcija vraća listu sadržaja za dati žanr.

Ovde unesite reč za pretragu.

Zatvorite pretragu.

Da biste koristili alatku za pretragu, prvo morate da se povežete na mrežu.

Rezultati pretrage mogu da se razlikuju u zavisnosti od programi, regiona, mrežnih podešavanja i od toga da li ste prihvatili odredbe i uslove.

8. POVEZIVANJE SPOLJNIH UREĐAJA

Korišćenje kućne kontrolne table

Korišćenje kućne kontrolne table

Uređaj povezan sa TV-om (mobilni, eksterni, kućni IoT, itd.) se može izabrati ili kontrolisati.

Pritisnite  dugme na daljinskom upravljaču i izaberite Početna kontrolna tabla.

Takođe možete pritisnuti i držati  dugme na daljinskom upravljaču.



Aplikacija LG ThinQ vam omogućava da pregledate i izaberete povezani pametni uređaj.

Za dodatne informacije o proceduri, pogledajte odeljak Uputstva za korisnike Povezivanje spoljnih uređaja Povezivanje pametnih uređaja.

Pametni gadžet koji je povezan preko Bluetooth-a može da reprodukuje zvuk.

Za više informacija o tome kako da obavite aktivnost, pogledajte odeljak Uputstva za korisnike o povezivanju spoljnih uređaja i reprodukciji zvuka sa pametnog uređaja preko zvučnika televizora.

Spoljni uređaj povezan preko eksternog ulaznog porta ili mreže može se proveriti i izabrati. Možete da pretražujete do ekrana podešavanja izlaznog zvučnika sa ekrana trenutno izabranog izlaznog zvučnika.

Priloženi uređaj za skladištenje je vidljiv i može se izabrati.

Povezani uređaj se može proveriti i njime se upravlja pomoću kućnog interneta stvari.

Za dodatne informacije o proceduri, pogledajte odeljak Uputstva za korisnike Povezivanje spoljnih uređaja Povezivanje kućnih IoT uređaja.

Konfigurisanjem željenih operacija unapred, vaš uređaj je jednostavan za kontrolu.

Logiraj se : Na LG ThinQ nalog koji ste kreirali na mobilnom uređaju možete da se prijavite i odjavite.

Urediti : Možete da promenite naziv povezanog uređaja u Ulazni ili Kućni IoT uređaji, kao i njegova podešavanja.

Njime se ažurira lista uređaja.

Izađite iz kućne kontrolne table.



U zavisnosti od modela ili regiona, dostupna su različita podešavanja.

POVEZIVANJE SPOLJNIH UREĐAJA

Povezivanje kućnih IoT uređaja

Povezivanje kućnih IoT uređaja

Status povezanih kućnih IoT uređaja može se proveriti i njime se upravlja.

1. Preuzmite aplikaciju LG ThinQ na svoj telefon.
2. Registrujte svoj LG ThinQ uređaj tako što ćete se prijaviti na svoj LG ThinQ nalog.
3. Pritisnite  dugme na daljinskom upravljaču i izaberite Početna kontrolna tabla.
4. Pritisnite  u gornjem desnom uglu da izaberete Prijava.
5. Otvorite svoj LG ThinQ nalog i prijavite se. Biće navedeni LG ThinQ uređaji koji su registrovani.

Povezivanje LG ThinQ uređaja neće biti podržano ako se nalazite u regionu gde aplikacija LG ThinQ nije dostupna.

Možda nećete moći da upravljate spoljnim uređajem sa TV-a ako koristite mobilnu aplikaciju da ga kontrolišete. Da biste ga kontrolisali sa TV-a, zatvorite mobilnu aplikaciju.

1. Konfigurisanjem željenih operacija unapred, vaš uređaj je jednostavan za kontrolu.
2. Na LG ThinQ nalog koji ste kreirali na mobilnom uređaju možete da se prijavite i odjavite.
3. Uredi listu: Povezani uređaji sa kućnim IoT uređajima mogu se preimenovati, učiniti vidljivim ili nevidljivim ili promeniti redosledom.

Obaveštenje: Možete dobiti upozorenja o stanju kućnih IoT uređaja ako ga uključite.

Izbrisi: Priključeni uređaj se može ukloniti. Samo određene gadžete mogu da se uklone sa televizora.

4. Možete pogledati uputstva za povezivanje kućnih IoT uređaja. Vaši uređaji registrovani na LG ThinQ nalogu mogu se povezati i prikazati.

Kartica će se smanjiti i pomeriti se na dno liste povezanih uređaja nakon što se uređaj uspostavi.

U zavisnosti od modela ili regiona, dostupna su različita podešavanja.

IoT uređaji kompatibilni sa TV-om podložni su promenama bez prethodnog obaveštenja.

Ponuđene funkcije i opcije povezivanja mobilnih i TV LG ThinQ uređaja mogu se razlikovati.

Povezivanje pametnih uređaja.

Sinhronizacijom televizora sa pametnim uređajem možete pristupiti brojnim uslugama.

LG ThinQ aplikacija za povezivanje vašeg pametnog uređaja sa televizorom

1. LG ThinQ aplikaciju možete preuzeti iz prodavnice aplikacija na vašem pametnom uređaju. Skenirajte QR kod da biste brzo preuzeli aplikaciju.



Android iOS



FOX LED TV

POVEZIVANJE SPOLJNIH UREĐAJA

Vaš pametni uređaj i TV treba da budu povezani na istu Wi-Fi mrežu.

Možete proveriti Wi-Fi mrežu televizora na  →  → Veza → Podešavanja mrežne veze → Wi-Fi veza. Otvorite aplikaciju LG ThinQ koja je preuzeta na vaš pametni telefon.

Da biste svoj pametni uređaj povezali sa televizorom, u skladu sa uputstvima koje pruža LG ThinQ aplikacija.

Kada su informacije o vašem LG ThinQ nalogu povezane sa televizorom, možete da koristite kućnu kontrolnu tablu televizora da kontrolišete IoT uređaje koji su povezani sa vašim nalogom.

Korišćenje LG ThinQ aplikacije za kontrolu televizora

Da biste upravljali televizorom, dodirnite dugmad na ekranu svog pametnog uređaja.

1. Kada gledate emitovanje, možete da koristite glasovne komande umesto daljinskog upravljača da promenite kanal, jačinu zvuka ili spoljni ulaz.
2. Tasteri sa strelicama i pokazivači na Magični daljinski upravljaču se mogu koristiti na isti način.

U režimu eksternog unosa, neke kontrole mogu biti ograničene.

Ekran i karakteristike aplikacije su podložni promeni bez prethodne najave.

Dostupne funkcije mogu da se razlikuju u zavisnosti od vaše zemlje i operativnog sistema.



Gledanje ekrana pametnog uređaja na TV-u

Za prikaz ekrana mobilnog uređaja na TV-u Na mobilnom uređaju uključite režim deljenja ekrana.

Na listi dostupnih uređaja, vaš TV će biti vidljiv.

Izaberite svoj TV i podnesite zahtev za povezivanje.

U iskačućem prozoru zahteva za povezivanje kliknite na Prihvati.



Ekran povezanog uređaja će se pojaviti na TV-u kada se veza uspostavi.

Kada se prvobitno povežete na Screen Share, pojaviće se iskačući prozor iz kojeg možete ili odbiti, prihvatiti ili blokirati.

Odbiti: Ne pokušavajte da povežete gadžet. Iskačući prozor će se pojaviti ako ponovo pokušate da se povežete.

prihvatiti: Uređaj se može povezati. Drugi put se neće prikazati upit za povezivanje.

Blokirati: Ne pokušavajte da povežete gadžet. Iskačući prozor se neće pojaviti čak i ako pokušate ponovo da se povežete, a veza neće biti uspešna.

Da biste otkazali Blokiraj, idite na  →  → Veza → Upravljanje mobilnom vezom → Deljenje ekrana.

Za pouzdanu vezu, savetuje se da uvek ažurirate OS na bilo kom uređaju koji je povezan sa vašim TV-om na najnoviju verziju.

Čak i kada se otkrije, uređaj koji nije LGE možda neće biti povezan.

Preporučuje se da povežete uređaj na ruter od 5 GHz jer vaše bežično okruženje može uticati na performanse.

U zavisnosti od okoline korisnika, stopa odgovora se može promeniti.

Razlikuje se od uređaja. Za više detalja pogledajte uputstvo za upotrebu uređaja na koji želite da se povežete.

Ako više puta ne uspete da se povežete, isključite TV i željeni uređaj, a zatim ih ponovo uključite i pokušajte ponovo.

POVEZIVANJE SPOLJNIH UREĐAJA

Reprodukcija muzike preko zvučnika televizora pomoću pametnog uređaja

Reprodukcija muzike preko zvučnika televizora pomoću pametnog uređaja

Da biste reprodukovali zvuk sa pametnog uređaja preko zvučnika televizora, uparite pametni uređaj sa televizorom pomoću Bluetooth-a.

1. Izaberite TV sa liste uređaja nakon što uključite Bluetooth na pametnom uređaju.
2. Pametni uređaj će biti povezan sa televizorom.

Televizor se možda neće pojaviti na listi pametnih uređaja ako je izlazni zvučnik podešen na Bluetooth ili ima istoriju podešavanja.

Ako je izlazni zvučnik podešen na Bluetooth, pokrenite Home Dashboard pritiskom i držanjem dugmeta za odabir ulaza na daljinskom upravljaču, a zatim izaberite Sound Share u odeljku Mobilni uređaji da biste se povezali.

USB veza

USB veza

Da biste videli datoteke sadržaja uskladištene na USB uređaju za skladištenje na vašem TV-u, povežite USB uređaj za skladištenje (USB HDD, USB stick) na USB port televizora.

Saveti za korišćenje USB uređaja za skladištenje podataka

Moguće je da USB uređaj za skladištenje koji koristi sopstveni upravljački program ili ima integrisani automatski program za prepoznavanje neće biti prepoznat.

Neki USB uređaji za skladištenje možda nisu kompatibilni sa njima ili rade loše.

Gledanje fotografija i video zapisa

Gledanje fotografija i video zapisa

Aplikacija za fotografije i video vam omogućava da pregledate slike i video zapise.

1. Pritisnite  dugme na daljinskom upravljaču.
2. Aktivirajte aplikaciju za fotografije i video.
3. Izaberite uređaj za skladištenje po svom izboru.
4. Izaberite i pogledajte fotografiju ili video po svom izboru.

Slušanje muzike

Performing Music

1. Koristeći aplikaciju Muzika, možete slušati muziku.

Na daljinskom upravljaču pritisnite dugme HOME.

2. Pokrenite aplikaciju Muzika.
3. Izaberite uređaj za skladištenje po svom izboru.

Možete da izaberete pesme koje želite da dodate na svoju listu pesama sa svih svojih uređaja za skladištenje.

4. Izaberite muziku koju želite da slušate i uživajte u njoj.

9. ISKORISTITE NAJBOLJE OD PAMETNE TV

Surfovanje Internetom na TV-u

Korišćenje veb pretraživača

Kada unesete adresu veb lokacije u URL traku, možete joj pristupiti.

Kada unesete pojam za pretragu, pretraživač će pronaći informacije o tom terminu.

Pritisnite  dugme na daljinskom upravljaču.

Pokrenite program veb pretraživača.

1. Možete ponovo učitati veb lokaciju na kojoj se nalazite.
2. Možete da unesete veb URL ili ključnu reč za pretragu da biste direktno došli do određene veb lokacije.

3. Kartice koje su trenutno otvorene mogu se videti.

4. Na veb lokaciji koju posećujete možete sprečiti reklame.

Funkcija Koristi blokiranje oglasa u podešavanjima ikona menija mora biti uključena da bi se ovo dugme pojavilo.

5. Da biste prikazali TV ekran, podelite ekran. Pretraživanje veb stranica je moguće dok gledate TV.

6. Dok istražujete veb lokaciju, možete povećati ili smanjiti sliku na ekranu.

Dodaj u obeleživače: Možete da obeležite veb lokaciju koju trenutno posećujete.

Istorija: Istorija poseta veb lokaciji se može pregledati i ukloniti.

Obeleživača: Lista veb lokacija koje ste dodali u svoje favorite dostupna je za pregled i brisanje.

Podešavanja: Podešavanja vašeg veb pretraživača su podesiva.

7. Izađite iz veb pretraživača.

8. Lista preporučenih i najposećenijih sajtova može se naći na ekranu nove kartice.

Podesite podešavanja ikona menija Prikaži preporučene lokacije na Isključeno ako ne želite da preporučene lokacije budu vidljive.

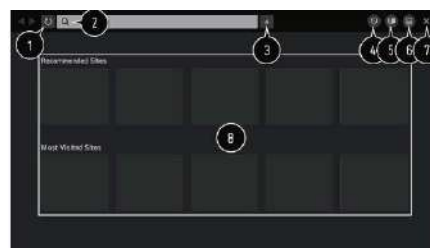

10. PODEŠAVANJA

Brza podešavanja

Da biste brzo koristili funkciju podešavanja

Lagane kontrole koje su lako i brzo dostupne, kao što su režim slike, izlaz zvuka i tajmer za isključivanje.

Pritisnite  dugme na daljinskom upravljaču.

Režim slike se može izabrati.

Režim zvuka se može podesiti.

Možete da izaberete Izlaz zvuka.

Može se podesiti tajmer za spavanje.
ekran za povezivanje, molim.

Može se uneti više izbora.

Stavke brzog podešavanja mogu se dodati, ukloniti ili preurediti.

Pritisnite i držite dugme Točak (OK) na daljinskom upravljaču nakon ulaska u svaku stavku da biste pristupili povezanom meniju.



PODEŠAVANJA

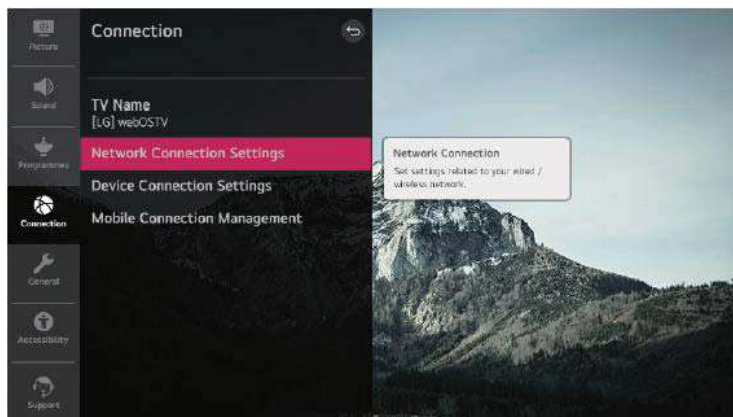

Slika

Režim slike

Izbor režima slike

⚙️ → 📺 → Slika → Podešavanja režima slike → Režim slike

Izaberite vizuelno podešavanje koje najbolje odgovara vašem okruženju za gledanje, ličnim preferencama ili video formatu.

Odredite režim slike. Vaš film je bolje optimizovan za svoje karakteristike finim podešavanjem i prilagođavanjem svake komponente u zavisnosti od režima.

Stavke koje se mogu prilagoditi razlikuju se u zavisnosti od modela.

Kada koristite normalne signale.

Živopisan

Izoštava sliku poboljšavajući kontrast, osvetljenost i oštrinu.

Eko / APS

Opcija uštede energije menja podešavanja televizora kako bi se smanjila potrošnja energije.

Stavke koje se mogu prilagoditi razlikuju se u zavisnosti od modela.

Bioskop

Pogodna slika za filmove.

Sport / Fudbal / Kriket

Pogodna slika za sportski događaj. izoštrava percepciju brzih pokreta poput udaranja ili bacanja lopte.

U zavisnosti od lokacije, sport može imati drugačije ime.

Igra

Pogodna slika za igru.

Kada koristite HDR signale

Živopisan

Izoštava sliku poboljšavajući kontrast, osvetljenost i oštrinu.

Standardno

On stvara ekran koji može precizno prikazati ekspresivnost i osvetljenost HDR-a u tipičnom scenariju gledanja.

Bioskop

Pogodna slika za HDR video signala.

PODEŠAVANJA

Igra

Pogodna slika za igru.

Vizuelni režimi koji se nude mogu varirati u zavisnosti od ulaznog signala.

Režim slike se može podesiti tako da odgovara sadržaju koji se vidi kada se koristi onlajn usluga.

Promene u režimu slike mogu da promene podešavanja za uštedu energije i da utiču na potrošnju energije.

U meniju Ušteda energije možete ručno da promenite njihova podešavanja.

Podešavanja režima slike

Fino podešavanje režima slike

 →  → Slika → Podešavanja režima slike

Pomoću ove opcije možete fino podesiti izabrani režim slike.

Pozadinsko osvetljenje

Podešava osvetljenost ekrana menjanjem pozadinskog osvetljenja. Ekran je svetliji što je bliži 100.

Smanjite pozadinsko osvetljenje da biste smanjili potrošnju energije.

Ne možete promeniti pozadinsko osvetljenje ako je Ušteda energije postavljena na Maksimalno.

U ovom slučaju, idite na  →  → Slika → Ušteda energije i podesite na Isključeno ili Minimalno.

Kontrast

Prilagodite svetli i tamni kontrast slike. Što je bliže 100, veći je kontrast.

Osvetljenost

Podešava ukupnu osvetljenost ekrana. Ekran je svetliji što je bliži 100.

Da biste podesili tamni deo slike, možete posebno da koristite podešavanja osvetljenosti.

Oštrina

Podešava oštrinu slike. Slika postaje oštrija i jasnija kako se približava 50.

Boja

Smanjuje ili osvetljava boje na ekranu. Boja je dublja što je bliža 100.

Nijansa

Postavlja kontrast crvene i zelene boje ekrana na željeni nivo. Boja će izgledati crvenije što se približava crvenoj 50. Boja će biti zelena što je bliža zelenoj 50.

Temperatura boje

Podešava ukupni ton boje slike. Dobijate topliji ton kada snizite postavku i hladniji ton kada ga podignete.

Parametri koje odaberete će uticati samo na režim unosa koji je sada izabran.

Izaberite Primeni na sve ulaze da primenite trenutna podešavanja slike na sve režime unosa.

Mogućnosti se mogu razlikovati u zavisnosti od dostavljenog signala ili izabranog režima slike.

Stavke koje se mogu prilagoditi razlikuju se u zavisnosti od modela.

Resetovanje režima slike

 →  → Slika → Podešavanja režima slike → Resetovanje

Nakon što definišete podešavanja slike, kliknite na resetovanje za svaki režim slike ako želite da vratite podešavanja slike na fabričke vrednosti.

Napredne kontrole

Podešavanje opcija napredne kontrole

 →  → Slika → Podešavanja režima slike → Napredne kontrole

Dinamički Kontrast

U zavisnosti od osvetljenosti slike, ispravite nejednakost između svetlih i tamnih strana ekrana da biste postigli najbolje rezultate.

FOX LED TV

PODEŠAVANJA

Dinamička boja

Izmenite boju i zasićenost slike da biste dodali dodatnu živost i boju.

Gamma

Promena srednje osvetljenosti slike.

Za svetlu sliku, izaberite Nisko; za tamnu sliku izaberite Visoko1 ili Visoko2; ili za sliku srednje osvetljenosti, izaberite Srednja.

Opcije su 1.9/2.2/2.4/BT.1886 za Pozorište uživo i Ekpert (Svetla soba)/Ekpert (Tamna soba), respektivno. Gradacija međunarodnog standarda ITU-R BT.1886 je izražena kao Visoko2/BT.1886.

Mogućnosti se mogu razlikovati u zavisnosti od dostavljenog signala ili izabranog režima slike.

Opcije slike

Podešavanje opcija slike

 →  → Slika → Podešavanja režima slike → Opcije slike.

Smanjenje buke

Čini sliku čistom uklanjanjem malih, uočljivih tačaka.

Crni nivo

Podešava osvetljenost tamnih oblasti slike.

Da biste ekran učinili svetlijim ili tamnijim, izaberite High ili Lov.

Ovu mogućnost možete koristiti kada koristite eksterni ulaz za pregled materijala.

Pravi bioskop

Povećajte performanse prikaza filmova.

TruMotion

Kvalitet slike pokretnih fotografija je odgovarajući.

Ugasiti: Isključite TruMotion.

Bioskop jasno : Podešava podrhtavanje pokreta na ekranu da simulira boravak u bioskopu.

Prirodno: Postavlja fotografije sa nekoliko pokreta da izgledaju prirodno i jasno.

Glatko: Izglađuje slike koje se brzo kreću.

Korisnik: TruMotion je ručno podešen.

De-Judder: Podešava podrhtavanje ekrana.

De-Blur: Smanjuje uticaj zamućenja pokreta.

Motion Pro: Kontrola svetla se može koristiti za poboljšanje jasnoće pokretnih fotografija.



Samo u korisničkom režimu se napredna podešavanja mogu uređivati.

Mogućnosti se mogu razlikovati u zavisnosti od dostavljenog signala ili izabranog režima slike.

Stavke koje se mogu prilagoditi razlikuju se u zavisnosti od modela.



Podešavanja odnosa širine i visine

Podešavanje veličine ekrana

 →  → Slika → Podešavanja odnosa širine i visine → Proporcija širine i visine

U skladu sa vrstom informacija koje gledate, možete podesiti veličinu ekrana.

Koristeći Samo skeniranje, pogledajte ekran

 →  → Slika → Podešavanja odnosa širine i visine → Samo skeniraj

Ako omogućite ovu funkciju, možete da vidite sadržaj u odnosu širine i visine signala emitovanja ili izvora sadržaja. Isključite ga ako ivica ekrana nije čista.

Kada je podešeno na Auto, funkcija menja svoj status iz Uključeno u Isključeno na osnovu podataka uključenih u video signal.



U zavisnosti od unosa, nekoliko objekata može biti dostupno za izbor.

FOX LED TV

PODEŠAVANJA

Ušteda energije

Da biste koristili funkciju uštede energije

 →  → Slika Ušteda energije

Podešava osvetljenost ekrana radi smanjenja potrošnje energije.

Ugasiti

Isključuje režim uštede energije.

Minimum / Srednji / Maksimum

Primenjuje unapred podešeni režim uštede energije.

Ekran je isključen

Reproducira se samo zvuk, a ekran je isključen.

Da biste ponovo uključili ekran, pritisnite bilo koje dugme osim tastera za napajanje i jačinu zvuka.

Osvetljenost vašeg TV-a će biti smanjena ako koristite opciju za uštedu energije.

Režim udobnosti za oči

Da biste koristili funkciju režima udobnosti za oči

 →  → Slika → Dodatna podešavanja → Režim udobnosti za oči

Temperatura boje će se podesiti kako bi se smanjio zamor očiju.

Upaliti: Temperatura boje vašeg TV ekrana je promenjena..

IskljUgasiti: učeno: Isključuje Režim udobnosti očiju.

Možda postoje modeli koji nisu podržani.

HDMI ULTRA HD Duboka boja

HDMI ULTRA HD Duboka boja

Podešavanja → Ikona Sva podešavanja → Slika → Dodatna podešavanja → HDMI ULTRA HD Duboka boja.

Uređaj koji podržava HDMI ULTRA HD Duboka boja može da se poveže da biste dobili oštriju sliku.

Nakon uspostavljanja veze, uključite HDMI ULTRA HD Duboka boja na uređaju za reprodukciju.

Možda neće ispravno funkcionisati ako povezani uređaj ne podržava ovu funkciju.

U toj situaciji promenite postavku HDMI ULTRA HD Duboka boja na TV-u na Isključeno.



Podržana rezolucija ekrana

Uključeno: Podržava 4K @ 60 Hz (4:4:4, 4:2:2 i 4:2:0)

Ugasiti: Podržava 4K@60 Hz (4:2:0)

Trenutni odgovor na igru

Korišćenje trenutni odgovor na igru

 →  → Slika → Dodatna podešavanja → Trenutni odgovor na igre

Da biste igrali igrice sa najboljim mogućim videom za igru, uključite HDMI port koji je povezan sa uređajem.

Radi samo kada se  →  → Zvuk → Zvuk je interni TV zvučnik/audio

Izlaz (linijski izlaz)/žičane slušalice/žičane slušalice + unutrašnji TV zvučnik.

PODEŠAVANJA

Zvuk

Podešavanja režima zvuka

 →  → Zvuk → Podešavanja režima zvuka

Režim zvuka

Za svaki žanr možete odabrati najbolji režim zvuka.

Standardno: Optimizira zvuk za različite oblike sadržaja.

Bioskop: Poboljšava zvuk u filmovima.

Jasan glas III / Jasan glas IV : Poboljšava jasnoću glasa.

Sport / fudbal / kriket : Poboljšava zvuk u sportskim igrama.

Muzika: Poboljšava zvuk muzike.

Igra: Poboljšava zvuk za igranje igara.

Balans

Jačina zvuka svakog zvučnika se može menjati, levo i desno.

ULTRA okružuje

Iskoristite virtuelni višeprogramski efekat surround zvuka da doživite impresivan audio pejzaž.

Ako je Režim zvuka podešen na Standard, ova opcija se može aktivirati.

Ekvilajzer

Ekvilizacija se može lako podesiti da bi se obezbedio željeni zvuk.

(100 Hz/300 Hz/1 kHz/3 kHz/10 kHz)

Ako je Režim zvuka podešen na Standard, ova opcija se može aktivirati.

Resetovanje

Možete resetovati podešavanja zvučnih efekata.

Ako je Režim zvuka podešen na Standard, ova opcija se može aktivirati.

Samo interni TV zvučnik ima pristup ovom podešavanju.

Stavke koje se mogu konfigurisati se razlikuju u zavisnosti od modela

Izlaz zvuka

Podešavanje izlaza zvuka

 →  → Zvuk → Izlaz zvuka

Ako odaberete WiSA Zvučnici/Optički/HDMI ARC za Izlaz zvuka kada je Instant Game Response podešen na On, može doći do kašnjenja zvuka.

Prebacite se na interni TV zvučnik ili promenite  →  → Zvuk → Dodatna podešavanja → HDMI Ulaz audio formata u PCM.

Interni TV zvučnik

Audio se reprodukuje preko unutrašnjih zvučnika televizora.

Bluetooth

Da biste ugodnije uživali u zvuku sa TV-a, bežično povežite Bluetooth audio uređaj.

Za informacije o tome kako da se povežete i koristite Bluetooth audio uređaj, pogledajte uputstvo za upotrebu.

Da biste videli povezane uređaje ili uređaje koji se mogu povezati da biste povezali bilo koji od njih, izaberite LISTA UREĐAJA iz menija.

Kada uključite TV, LG Zvuk Sink uređaji će odmah pokušati da se povežu sa nedavno korišćenim uređajima.

Savetuje se da koristite režim LG TV ili režim LG Zvuk Sink na svom uređaju da biste povezali LG audio uređaj koji podržava LG Zvuk Sink.

Proverite napajanje uređaja na koji želite da se povežete i uverite se da audio uređaj ispravno funkcioniše ako se uređaj ne može povezati.

Bluetooth uređaj se možda neće pravilno povezati ili će pokazati čudno ponašanje, kao što su audio i video koji nisu sinhronizovani, u zavisnosti od tipa.

(Možda slušalice samo za mobilne uređaje neće funkcionisati.)

FOX LED TV

PODEŠAVANJA

Sledeći uslovi mogu uzrokovati da zvuk zamuckuje ili izgubi kvalitet:

Televizor je predaleko od Bluetooth uređaja;

Bluetooth uređaj i TV su odvojeni barijerama; ili

koristi se u kombinaciji sa radio opremom, kao što je bežični LAN ili mikrotalasna pećnica.

Ako se problem nastavi, savetujemo vam da pređete na žičanu vezu. (ARC port na HDMI, optički digitalni)

WiSA Zvučnici

Zvučnik pod nazivom WiSA Zvučnici koristi tehnologije za bežično isporuku višekanalnog zvuka od 5.1 kanala. Da biste iskusili zvuk visokog kvaliteta, možete bežično da povežete TV sa WiSA zvučnicima.

Da biste promenili određene postavke WiSA zvučnika, izaberite LISTA UREĐAJA.

Možda postoje modeli koji nisu podržani.

Morate da povežete jedinstveni ključ da biste koristili WiSA zvučnike.

U oblastima sa bežičnim smetnjama, mogu se desiti problemi sa vezom WiSA Dongle i WiSA zvučnika. U ovoj situaciji, stupite u kontakt sa proizvođačem zvučnika.

Da biste saznali više o kupovini proizvoda koje je odobrila WiSA, proverite na www.wisaassociation.org.

Optički

Da biste uživali u zvuku vašeg TV-a u višem kvalitetu i sa većom pogodnošću, možete da povežete audio uređaj koji podržava optički na optički digitalni audio izlazni konektor.

Dostupno samo na modelima opremljenim optičkim digitalnim portom.

Daljinski upravljač za TV se može koristiti za promenu jačine zvuka na nekim uređajima.

HDMI ARC

Preko spoljnog audio uređaja povezanog preko HDMI (ARC) konektora, zvuk sa TV-a se može emitovati.

Da biste automatski uključili SIMPLINK, izaberite HDMI ARC. Za kontinuirani audio izlaz kada se SIMPLINK isključi, postavke izlaznih zvučnika se automatski vraćaju na svoje podrazumevane pozicije.

Audio izlazni (linijski izlazni) / Žičane slušalice

U zavisnosti od povezanog uređaja, izaberite žičane slušalice ili audio izlaz (linijski izlaz) da biste optimizovali audio izlaz.

Možda postoje modeli koji nisu podržani.

Kada priključite žičane slušalice dok je TV uključen, on ih trenutno prepoznaje i usmerava zvuk preko njih.

Korišćenje eksternog audio uređaja i unutrašnjih zvučnika televizora za reprodukciju audio zvuka može se istovremeno reprodukovati na nekoliko različitih uređaja.

Optički + interni TV zvučnik

I audio uređaj priključen na konektor za digitalni optički audio izlaz i ugrađeni zvučnici na TV-u istovremeno reprodukuju zvuk.

Žičane slušalice + interni TV zvučnik

Žičane slušalice i ugrađeni zvučnici televizora puštaju muziku istovremeno.

Možda postoje modeli koji nisu podržani.

Kada priključite žičane slušalice dok je TV uključen, on ih trenutno prepoznaje i usmerava zvuk preko njih.

Tip instalacije TV-a

 →  → Zvuk → Dodatna podešavanja → Tip instalacije TV-a

U skladu sa TV podešavanjem, ova opcija optimizuje zvuk.

Stani

Ako je televizor montiran kao postolja, izaberite ovo.

Zid

Ako je vaš TV montiran na zid, izaberite ovo.

Samo interni TV zvučnik ima pristup ovom podešavanju.

PODEŠAVANJA

Režim jačine zvuka

Podešavanje režima jačine zvuka

⚙️ → ⓘ → Zvuk → Dodatna podešavanja → Režim jačine zvuka

Automatska jačina zvuka

Da biste slušali programe na željenoj jačini zvuka čak i nakon promene programi, kliknite na Uključeno da biste omogućili automatsko podešavanje jačine zvuka za različite kompanije za emitovanje.

Povećanje zapremine

Izaberite Nisko, Srednje ili Visoko da biste promenili postavku jačine zvuka. Veće vrednosti povećavaju priraštaje.

Samo interni TV zvučnik ima pristup ovom podešavanju.

DTV audio podešavanje

⚙️ → ⓘ → Zvuk → Dodatna podešavanja → DTV audio podešavanje

Ova funkcija vam omogućava da izaberete željeni audio tip kada su druge vrste zvuka prisutne u ulaznom signalu.

Ako je podešeno na Auto, redosled pretrage je AC4 → HE-AAC → Dolbi Digitalni Plus → Dolbi Digitalni → MPEG i izlaz se proizvodi u prvom pronađenom audio formatu.

U zavisnosti od nacije, sledeći redosled pretrage može da se razlikuje: AC4 → HE-AA → Dolbi Digitalni Plus → Dolbi Digitalni → MPEG.

Drugi audio format se može koristiti za izlaz ako izabrani audio format nije podržan.

Možda postoje modeli koji nisu podržani.

AV sinhronizacija podešavanje

Prilagođavanje AV sinhronizacije

⚙️ → ⓘ → Zvuk → Dodatna podešavanja → AV sinhronizacija podešavanje

Podešava sinhronizaciju zvuka iz trenutno aktivnog zvučnika.

Audio izlaz se kreće sporije što je bliže većem nego što jeste.

Bypass, bez ikakvog odlaganja zvuka, emituje signale ili zvuk sa spoljnih uređaja.

Zbog toga koliko dugo TV-u treba da obradi video ulaz, zvuk se može emitovati pre videa. Dostupne opcije zavise od podešavanja Izlaz zvuka.

Audio format za HDMI ulaz

⚙️ → ⓘ → Zvuk → Dodatna podešavanja → HDMI ulazni audio format

Za svaki HDMI ulaz, audio format se može promeniti. Podesite ga na PCM ako glas koji se dobija preko HDMI konektora nije sinhronizovan.

Sinhronizacija zvuka LG

⚙️ → ⓘ → Zvuk → Dodatna podešavanja → Sinhronizacija zvuka LG

Podesite Izlaz zvuka na Optical i priključite Sinhronizacija zvuka LG uređaj na optički digitalni ulazni port.

Možete da koristite daljinski upravljač za TV da biste promenili jačinu zvuka povezanog Sinhronizacija zvuka LG uređaja tako što ćete ovu opciju uključiti.

Kada se TV uključi ili isključi, zvučna traka će se takođe uključiti ili isključiti ako je funkcija automatskog napajanja zvučne trake koja podržava Sinhronizacija zvuka LG postavljena na Uključeno.

Digitalni izlaz zvuka

Postavka digitalnog izlaza zvuka

⚙️ → ⓘ → Zvuk → Dodatna podešavanja → Postavka digitalnog izlaza zvuka

Parametri digitalnog zvuka se mogu programirati.

Ova opcija je dostupna samo ako je postavka Izlaz zvuka za ikonu Podešavanja Sva podešavanja podešena na Optički/HDMI ARC.

Emitovanje zvučnih efekata možda neće biti moguće kada je omogućeno Prolaz.

Izlazni i ulazni signali kodeka uređaja mogu se razlikovati.



Dolbi Atmos: Možda postoje modeli koji nisu podržani.

PODEŠAVANJA

Programi

Automatsko podešavanje

Automatsko podešavanje programi

 →  → Programi → Podešavanje programi → Automatsko podešavanje

Automatski podešava programe.

Izaberite naciju u kojoj se televizor koristi. U zavisnosti od nacije koju izaberete, parametri programi se razlikuju.

Pokrenite automatsko podešavanje.

Izaberite režime podešavanja za programe.

Podesite automatsko podešavanje prema uputstvima na ekranu.

Registracija programi možda neće funkcionisati ako izvor ulaza nije pravilno povezan.

Automatsko podešavanje pronalazi samo programe koji se trenutno emituju.

Iskačući prozor sa zahtevom za lozinku će se pojaviti ako je Bezbednost omogućena.

Ručno podešavanje

Da biste koristili ručno podešavanje programi

 →  → Programi → Podešavanje programi (Podešavanje programi i podešavanja) → Ručno podešavanje

Ova funkcija omogućava ručno pronalaženje i čuvanje programi.

Kvalitet i jačina signala se mogu proveriti za digitalni prenos.

Testiranje signala

Da biste koristili testiranja signala

 →  → Programi → Podešavanje programi (Podešavanje programi i podešavanja) → Testiranje signala

Prikazuje MUKS i servisne informacije itd.

Samo režimi antene ili kabla nude testiranja signala.

Možda postoje modeli koji nisu podržani.

Menadžer programi

Uredi programi

Programe koje ste izabrali između svih onih koje ste sačuvali možete uređivati, a možete ih dodati/brisati u/iz omiljenih programi.

Uredite listu svih programi

 →  → Programi → Menadžer programi → Uredi sve programi

Među svim sačuvanim programima, možete zaključati ili otključati odabrane programe, ili možete odlučiti da ih preskočite kada se krećete između programi.

1. Podesite opciju sortiranja.

2. Zaključaj/Otključaj: Zaključajte programe koje ste izabrali da zaključate ili otključate zaključane programe.

Preskoči / Vrati: Podesite da se odabrani programi preskaču dok menjate kanale ili isključite opciju za preskakanje prethodno izabranih programi.

Potez : Pomerite izabrane programe.

Uredite brojeve programi: Promenite brojeve izabranih programi.

Izbriši: Izbrišite programe koje ste izabrali.

Dostupne funkcije se mogu promeniti u zavisnosti od emitovanog signala.

Satelitske programe za model koji ih podržava možete kontrolisati u Uređivanje satelitskih programi (napredno).

Uredite listu omiljenih programi

 →  → Programi → Menadžer programi → Uredi omiljene

Možete da dodajete/brisete željene programe na/sa liste omiljenih, prilagođavate njihove pozicije itd.

1. Pritisnite dugme da biste dodali izabrane programe na listu omiljenih programi nakon što ih izaberete sa liste svih programi.

PODEŠAVANJA

- Izbrišite izabrane programe sa liste omiljenih programi.
- Potez : Na listi preferirani programi izaberite jednu ili više emisija, pritisnite dugme Premesti, a zatim odlučite gde da ih premestite. Programi koje ste izabrali će se pomeriti na lokaciju koju ste izabrali. Promenite naziv grupe: Lista omiljenih programi treba da ima novo ime. lista programi. Sortiraj po programu: Sortira listu omiljenih emisija prema programu.

Raznih uglova

 →  → Programi → Raznih uglova

Gledajući emitovanje snimljeno iz različitih perspektiva, možete gledati željeni ugao na TV-u.

Možda postoje modeli koji nisu podržani.

HbbTV

Saznajte više o HbbTV-u

HbbTV (Hibridno emitovanje širokopojasnog pristupa TV) je novi standard za emitovanje koji omogućava da se onlajn usluge koje se daju preko širokopojasnog pristupa povezanom Pametno TV-u kombinuju ili povežu sa uslugama tipa super-teleteksta koje pružaju televizijski programi koji se emituju.

Da biste videli detalje, kliknite na Uživajte TV-u uživo → Hbb TV u korisničkom vodiču.



Možda postoje modeli koji nisu podržani.

Šta je CI informacija

Nekim šifrovanim uslugama možete pristupiti uz pomoć ove funkcije (usluge plaćanja).

Kliknite na vezu Uživajte TV CI informacijama uživo u korisničkom priručniku da biste dobili detalje.

Sačuvaj CI lozinku

 →  → Programi → Sačuvaj CI lozinku

Unesite PIN kod u Sačuvaj CI lozinku. Nakon što ga sačuvate, ne morate da unosite pin kod.

Kada umetnete CI CAM (modul uslovnog pristupa) koji podržava pin kod, možete videti Sačuvaj CI lozinku.

Možete videti Resetovanje CI lozinku ako CI CAM ima PIN kod.

Kopiraj programi

 →  → Programi → Kopiraj programi



Informacije o programskom vodiču vašeg TV-a mogu da se izvezu na povezani USB uređaj za skladištenje ili Informacije o programskom rasporedu vašeg TV-a mogu da se uvezu sa povezanog USB uređaja za skladištenje.

Za satelitske modele

Veza

Ime TV-a

Podešavanje ime TV-a



 →  → Veza → Ime TV-a

Naziv pametnog televizora koji će se koristiti na mreži može se podesiti pomoću tastature na ekranu.

Ako koristite englesko pismo, može se uneti najviše 25 znakova.

Podešavanja mrežne veze

Podešavanja mrežne veze

 →  → Veza → Podešavanja mrežne veze

Možete da koristite brojne usluge, uključujući onlajn sadržaj i aplikacije, ako postavite mrežna podešavanja.

Podešavanje žičane mreže

Izaberite Žičanu vezu (Ethernet).

PODEŠAVANJA

TV i ruter povezani žicom će se automatski povezati na mrežu ako ruter na mreži podržava DHCP mogućnost. Možete izabrati Uredi da ručno konfigurirate mrežnu vezu ako automatsko podešavanje nije dostupno.

Podešavanje bežične mreže

Izaberite Vi-Fi veza.

Možete da tražite i pridružite se dostupnim bežičnim Internet mrežama ako ste konfigurisali televizor za bežičnu mrežu.

Dodajte skrivenu bežičnu mrežu

Bežična mreža se može dodati jednostavnim unošenjem imena mreže.

Povežite se preko WPS PBC-a.

Možete brzo da se povežete na bežični ruter pritiskom na dugme WPS-PBC na ruteru ako ima mogućnost Vi-Fi Zaštićeno podešavanje-konfiguracija dugmeta (WPS-PBC). Kliknite na dugme WPS-PBC na bežičnom ruteru, a zatim pritisnite dugme [Poveži] na TV-u da biste se povezali.

Povežite se preko WPS PIN-a.

Evo kako da koristite Vi-Fi zaštićeno podešavanje – lični identifikacioni broj za povezivanje sa pristupnom tačkom (WPS-PIN). Treba izabrati pristupnu tačku na koju želite da se povežete. Unesite PIN prikazan na Vi-Fi uređaju pristupne tačke.

Vi-Fi Advanced Settings

Kada uspostavite vezu sa bežičnom mrežom, možete proveriti detalje veze kao što je kompletna IP adresa. Pored toga, izborom opcije Uredi, možete da izmenite IP adresu i adresu DNS servera koje želite da koristite za povezivanje.

Uređivanje nije podržano u IPv6 podešavanju.

Za više informacija o tome kako da se povežete na mrežu, pogledajte Prvi koraci sa vebOS TV-om → Povezivanje na mrežu u Uputstvu za korisnike.

Upravljanje mobilnom vezom

 →  → Veza → Upravljanje mobilnom vezom

Možete odabrati da upravljate istorijom povezivanja ili da kontrolirate TV pomoću pametnog uređaja koji je povezan sa televizorom.

TV uključen sa mobilnim

Možete da uključite svoj TV pomoću mobilnog uređaja ako je TV uključen sa mobilnim omogućeno i Uključi preko Vi-Fi ili Uključi preko Bluetooth-a postavljeno na Uključeno.

Potrebno je uspostaviti mrežnu vezu za TV.

Predviđeni uređaj i TV moraju biti na istoj mreži.

Pametni uređaj mora da se koristi sa aplikacijom koja podržava funkciju Uključi preko Vi-Fi.

Samo neki mobilni telefoni koje proizvodi LG Elektronika mogu da koriste funkciju Uključi preko Bluetooth-a.

TV mora biti priključen.

Uverite se da je uređaj spreman za povezivanje pre prvog povezivanja.

Možda postoje modeli koji nisu podržani.

Deljenje ekrana

Istorija povezivanja uređaja koji je koristio Deljenje ekrana za povezivanje sa TV-om može biti izbrisana.

Podeli zvuk

Pametni uređaj koji je Bluetooth-om povezan sa televizorom može da izbriše istoriju povezivanja.

PODEŠAVANJA

Jezik

Konfigurisanje jezičkih postavki

 →  → Opšte → Jezik

Možete odabrati jezik menija koji se prikazuje na ekranu i audio jezik digitalnog emitovanja.

Jezik menija

Možete odabrati koji jezik menija će biti prikazan na ekranu. Jezik koji odaberete za meni će automatski biti postavljen kao jezik za prepoznavanje govora.

Samo nekoliko modela koristi prepoznavanje govora.

Primarni audio jezik / sekundarni audio jezik

Kada gledate digitalni program sa brojnim audio jezicima, možete da izaberete jezik koji želite.

Podrazumevano će se koristiti za programe koji ne podržavaju nekoliko jezika.

Odnosi se na digitalno emitovanje.

Jezici tastature

Da biste koristili tastaturu na ekranu, izaberite jezik.

Konfiguracija jezika teleteksta

Podešava jezik teleteksta.

Kliknite na Uživajte TV Teletekstu uživo u korisničkom vodiču da biste dobili informacije.

Samo u digitalnom režimu

Lokacija

Podešavanje lokacije

 →  → Opšte → Lokacija

Podešavanje lokacije vašeg Pametan TV-a može da se promeni.

Podešavanje adrese

Region i grad vašeg TV-a se mogu promeniti.

Broadcast Countri

Na TV-u možete promeniti naciju emitovanja.

Poštanski broj područja usluge

Koristeći ovu alatku, možete da promenite lokaciju emitovanja TV-a tako što ćete uneti svoj poštanski broj.

Services Countri

Naciju možete odabrati ručno ako ne koristite opciju Postavi automatski.

Kada niste povezani na mrežu, morate ručno da podesite zemlju.

Stavke koje se mogu prilagoditi razlikuju se u zavisnosti od modela.

PODEŠAVANJA

Vreme

 →  → Opšte → Vreme

Možete podesiti relevantna podešavanja ili proveriti vreme.

Automatsko podešavanje

Informacija o digitalnom emitovanju vremena poslata sa stanice za emitovanje ili servera se automatski koristi za podešavanje vremena TV-a.

Vreme / Datum / Vremenska zona

Ako je automatski podešeno trenutno vreme pogrešno, možete ručno da podesite vreme i datum.

Informacije o rasporedu, programski vodič i druge funkcije možda neće raditi ispravno ako je vreme ručno podešeno dok je antena povezana.

Prilagođena vremenska zona

Meni Prilagođena vremenska zona se aktivira kada se izabere opcija Prilagođeno u vremenskoj zoni.

Tajmeri

Tajmeri spavanja

Određuje vreme kada će se TV isključiti.

Odaberite Isključeno ako ne želite da koristite tajmer za spavanje.

Tajmer za uključivanje

Uključite tajmer za uključivanje.

U zakazano vreme, TV se uključuje i prikazuje unapred određenu stanicu.

Vreme: Odlučite u koje vreme treba da se uključi TV.

Ponavljanje tajmera: Odredite dan u nedelji. Da biste koristili funkciju samo jednom, podesite opciju na Ništa. Ulazni: Podesite eksterni ulaz da pokažete šta se dešava kada se napajanje uključi.

Program tajmera: Napravite kanal koji će početi da se reprodukuje kada se uključi. Samo kada je Input podešen na TV, ova opcija se može promeniti.

Jačina zvuka: Da bi se koristio kada je napajanje uključeno, podesite jačinu zvuka.

Tajmer za isključivanje

Uključite tajmer za isključivanje.

U naznačeno vreme, TV se isključuje.

Vreme: Podesite vreme u kojem ćete isključiti TV.

Ponavljanje tajmera: Odredite dan u nedelji. Da biste koristili funkciju samo jednom, podesite opciju na Ništa.

Automatsko isključivanje nakon 4 sata

Televizor će se automatski isključiti ako se nijedno dugme ne pritisne 4 sata nakon što ga je uključila funkcija kao što je Tajmer za uključivanje.

Podesite 4 sata automatskog isključivanja na Isključeno da biste sprečili da se televizor sam isključi.

Možda postoje modeli koji nisu podržani.

Uverite se da je tajming tačan pre upotrebe tajmera za uključivanje/isključivanje.

Ako je postavka Ponavljanje tajmera za uključivanje/isključivanje tajmera nema

Kada tajmer za uključivanje dostigne unapred određeno vreme dok gledate TV, napajanje će se automatski uključiti. Ovo će se nastaviti sve dok se televizor ne isključi sledećeg dana ili kasnije.

Kada tajmer za isključivanje dostigne unapred određeno vreme kada je TV u stanju pripravnosti i vreme je prošlo, napajanje će se automatski isključiti sledećeg dana ili kasnije dok se TV gleda.

PODEŠAVANJA

Zaključavanje TV rejtinga



Omogućavanje zaključavanja TV rejtinga

Ova funkcija se pokreće na osnovu podataka sa stanice. Kao rezultat toga, ako signal sadrži netačne informacije, ova funkcija je onemogućena.

U skladu sa ograničenjem ocena, sprečava decu da gledaju neke televizijske programe za odrasle.

Da biste gledali emisiju koja je blokirana, unesite lozinku. Ocena se razlikuje od zemlje do zemlje.

Na daljinskom upravljaču kliknite na dugme Podešavanja.

Izaberite  →  → Opšte → Bezbednost.

Podesite Bezbednost na Uključeno.

Izaberite Zaključavanje TV rejtinga.

Podržano na 9i u digitalnom režimu.

Možda postoje modeli koji nisu podržani.

Podrazumevana lozinka je "0000".

Kada su Francuska ili Norveška izabrane kao zemlja, lozinka je "1234" umesto "0000".

Zaključavanje programi

Omogućavanje zaključavanja programi

Blokira programi sa sadržajem koji je neprikladan za decu. Programi se mogu birati, međutim zvuk je isključen i ekran je prazan. Unesite lozinku da biste gledali program koji je zaključan.

Pritisnite  dugme na daljinskom upravljaču.

Izaberite  → Opšte → Bezbednost.

Podesite Bezbednost na Uključeno.

Izaberite Zaključavanje programi.

Izaberite Programe za zaključavanje.

Izaberite Zaključaj / Otključaj.

Podrazumevana lozinka je "0000".

Kada su Francuska ili Norveška izabrane kao zemlja, lozinka je "1234" umesto "0000".

Zaključavanje aplikacija

Omogućavanje zaključavanja aplikacija

Možete zaključati ili otključati aplikaciju.

Na daljinskom upravljaču kliknite na dugme Podešavanja.

Izaberite ikonu Sva podešavanja → Opšte → Bezbednost.

Podesite Bezbednost na Uključeno.

Izaberite Zaključavanje aplikacija.

Izaberite Aplikacije za zaključavanje.

Podrazumevana lozinka je "0000".

Kada su Francuska ili Norveška izabrane kao zemlja, lozinka je "1234" umesto "0000".

Aktivni program ne podržava trenutno funkciju zaključavanja.

Poništi lozinku

 →  → Opšte → Bezbednost → Poništi lozinku

Podesite ili promenite lozinku za TV.

Podrazumevana lozinka je "0000".

Kada su Francuska ili Norveška izabrane kao zemlja, lozinka je "1234" umesto "0000".

PODEŠAVANJA

Resetovanje izgubljene lozinke

Ako izgubite lozinku koju ste postavili, možete je resetovati na sledeći način:

1. Pritisnite dugme za podešavanja na daljinskom upravljaču.
2. Izaberite ikonu Sva podešavanja → Opšte → Bezbednost.
3. Pritisnite Programi gore → Programi gore → Programi dole → Programi gore na daljinskom upravljaču. Pojaviće se prozor za unos glavne lozinke.
4. U polje za unos glavne lozinke unesite brojeve „0313“, a zatim kliknite na Enter. Doći će do resetovanja lozinke.

Administracija naloga

Upravljanje vašim LG nalogom

Koristeći svoju adresu e-pošte, možete otvoriti novi LG nalog u Upravljanju nalogom.

Za više informacija pogledajte Početak rada sa vebOS TV-om → Upravljanje nalogom u Korisničkom vodiču.

Početna podešavanja

Početna podešavanja

⚙️ → ⋮ → Opšte → Početna podešavanja

Automatsko pokretanje kod kuće

Možete da programirate Kuća da se automatski pokrene kada se TV uključi.

Promocija kuće

Na početnom ekranu možete omogućiti ili onemogućiti oglašavanje.

Stavke koje se mogu prilagoditi razlikuju se u zavisnosti od modela.

Pomoć za podešavanja

Da biste koristili pomoć za podešavanja

Podešavanja → Ikona Sva podešavanja → Opšte → Dodatna podešavanja → Pomoć za podešavanja

Kada izaberete menije za podešavanja, videćete savete za podešavanje. U podešavanjima uključite/isključite okvir za opis.

Transparentnost menija

Podešavanje transparentnosti menija

⚙️ → ⋮ → Opšta dodatna podešavanja → Transparentnost menija

Možete da učinite neke od menija (kao što su meni uživo, pretraga i tako dalje) transparentnim uključivanjem ove funkcije.

Čuvar ekrana

Korišćenje čuvara ekrana

⚙️ → ⋮ → Opšte → Dodatna podešavanja → Čuvar ekrana

Nakon sat vremena, ako trenutno prikazana aplikacija nije primila nikakav korisnički unos, biće zamenjena čuvarom ekrana.

Podešavanje opcije Čuvar ekrana na Isključeno zadržava isti prikaz tokom dužeg vremenskog perioda, što može smanjiti kvalitet. Oštećeni ekran se možda neće vratiti.

Nema signalne slike

Konfigurisanje ekrana kada nema signala

⚙️ → ⋮ → Opšte → Dodatna podešavanja → Nema slike signala

Kada nema signala, možete uključiti ili isključiti prikazanu sliku.

Upaliti: Ako nema signala, prikazuje se podrazumevana slika.

Ugasiti: Ako nema signala, prikazuje se poruka Nema signala.

PODEŠAVANJA

Eko režim

Korišćenje EKO režima

⚙️ → ⋮ → Opšte → Dodatna podešavanja → Eko režim

Konfigurirate opcije napajanja da biste uštedeli energiju.

Automatsko isključivanje

Podesite televizor da se automatski isključi nakon određenog vremena ako ne primi nikakvu interakciju korisnika. Eko HDD režim

Kada je režim postavljen na Uključeno, USB HDD priključen na TV će ući u režim uštede energije ako se ostavi bez nadzora duži vremenski period.

Stavke koje se mogu konfigurirati se razlikuju u zavisnosti od modela

Brzi početak+

Podešavanje napajanja televizora

⚙️ → ⋮ → Opšte → Dodatna podešavanja → Brzi početak +

Kada isključite TV, on prelazi u režim pripravnosti, što mu omogućava da se brže pokrene kada ga sledeći put uključite.

Podesite Brzi početak+ na Uključeno.

Možda postoje modeli koji nisu podržani.

Uključivanje ove opcije može dovesti do povećane potrošnje energije.

Svetlo u stanju pripravnosti

Da biste podesili indikator napajanja

⚙️ → ⋮ → Opšte → Dodatna podešavanja → Svetlo u stanju pripravnosti

Lampica u stanju pripravnosti se može uključiti ili isključiti.

Možda postoje modeli koji nisu podržani.

Oglas

⚙️ → ⋮ → Opšte → Dodatna podešavanja → Oglas

Ako je vaš TV onlajn, vebOS može da koristi kolačić za ograničavanje frekvencije da zabeleži koliko često se reklama pojavljuje na vašem TV-u.

Ovi podaci se koriste za smanjenje broja prikazivanja iste reklame. Pristupanjem opciji Reklama na TV-u, možete da izbrišete ovaj kolačić ili da ga uključite ili isključite kad god želite.

Ovaj kolačić nije povezan ni sa kakvim ličnim podacima.

Možda postoje modeli koji nisu podržani.

Pristupačnost

Da biste koristili audio navođenje

⚙️ → ⋮ → Pristupačnost → Audio navođenje

Kada menjate programe, podešavate nivo, menjate podešavanja ili ulazne signale, na primer, ako je audio navođenje omogućeno, audio vodiči će se reprodukovati u ovim i drugim scenarijima.

Audio opis

Meni za osobe sa oštećenim vidom

⚙️ → ⋮ → Pristupačnost → Audio opis

Za gledaoce koji su slepi ili slabovidni, sadržaj ekrana će biti opisan glasom.

Ako kompanija za emitovanje nudi audio opis za slepe ili slabovide osobe, možete koristiti ovu opciju.

Možda postoje modeli koji nisu podržani.

PODEŠAVANJA

Audio Tipe

 →  → Pristupačnost → Audio Tipe

Oni koji slabo čuju ili imaju oštećenje vida mogu koristiti audio komentare ili titlove.

Normalno

Bira podrazumevani audio.

Audio opis

Izaberite izabrani podrazumevani zvuk zajedno sa zvukom za osobe sa oštećenim vidom.

Govorni titl



Izaberite poželjniji audio za osobe sa oštećenim vidom isključivo za one koji su slepi.

Bilo koji dodatni audio

Prikazuje sav dodatni zvuk.

Možda postoje modeli koji nisu podržani.

Dodatna audio funkcija

 →  → Pristupačnost → Dodatni audio izbor

Oni koji slabo čuju ili imaju oštećenje vida mogu koristiti audio komentare ili titlove.

Nijedan

Bira podrazumevani audio.

Audio opis

Izaberite izabrani podrazumevani zvuk zajedno sa zvukom za osobe sa oštećenim vidom.

Čisti zvuk

Odaberite preporučeni Čisti Efekat i Audio za osobe sa oštećenim sluhom za osobe sa oštećenim sluhom.

Govorni titl

Izaberite poželjniji audio za osobe sa oštećenim vidom isključivo za one koji su slepi.

Neki modeli možda nisu podržani

Veliki kontrast

Promena menija u ekran visokog kontrasta

 →  → Pristupačnost Visok kontrast

Pozadina i boje fonta nekoliko menija na ekranu se menjaju kada se ova funkcija uključi da bi se naglasio kontrast između svetlih i tamnih mesta.

Graiscale

 →  → Pristupačnost → Graiscale

Da bi nejasnoća menija na ekranu bila veoma jasna, promenite njegovu boju u crno-beli ton.

Postavite na Uključeno

Obrni boje

 →  → Pristupačnost → Obrni boje

Možete da invertujete i prilagodite određene boje u nekoliko podešavanja da biste poboljšali njihovu vidljivost na ekranu. Postavite na Uključeno

Teškoće sa sluhom

Za podešavanje naglušosti

Pritisnite  dugme na daljinskom upravljaču.

Izaberite  Pristupačnost.

Uključite titlove.

Uključite oštećenje sluha.

Biće dostupan natpis za one koji ne čuju.

Kada je aktivirana funkcija za oštećenje sluha, ona ima prednost nad standardnim natpisima.

Možda postoje modeli koji nisu podržani.

PODEŠAVANJA

Titlovi

Da biste podesili titl

 →  → Pristupačnost Titlovi

Kada TV kanal nudi programe sa titlovima, pogledajte titlove.

Izaberite podešavanje titla i uključite titlove. Možda postoje modeli koji nisu podržani.

Odnosi se na digitalno emitovanje.

Podrška

Ažuriranje softvera

 →  → Podrška ažuriranju softvera

Proverava i dobija najnoviju verziju putem ažuriranja softvera.

Dozvoli automatska ažuriranja

Ažuriranja će se nastaviti automatski bez pitanja da li postoji novo ažuriranje nakon provere verzije da li je postavka postavljena na Uključeno.

Proveri ažuriranja

Samo ako je datoteka za ažuriranje za noviju verziju dostupna tokom provere najnovije verzije ažuriranja, može se izvršiti ažuriranje. Televizor automatski proverava verziju softvera, ali možete je i ručno proveriti ako je potrebno.

TV informacije

 →  → Podrška → TV informacije

Podaci koji se mogu videti uključuju model, serijski broj i naziv uređaja.



Obaveštenja

Korišćenje obaveštenja

 →  → Obaveštenja o podršci

Možete istovremeno da pristupite svim obaveštenjima TV aplikacija i usluga. Svaka poruka sa obaveštenjem je vidljiva i izbrisana. Možete da odete direktno u aplikaciju ili veb lokaciju za obaveštenja koja dozvoljavaju prečice.

Dodatna podešavanja

 →  → Podrška za dodatna podešavanja

Korisnički ugovori

Ovo su uslovi privatnosti za korišćenje usluga koje se odnose na Smart TV.

Pravno obaveštenje



To je pravno obaveštenje za TV usluge.

Obaveštenje o softveru otvorenog koda

Uputstva za svaku stavku su dostupna za pregled.

Resetujte na početna podešavanja

Vraćanje podrazumevanih postavki

 →  → Podrška → Vрати na početna podešavanja

Resetujte TV na podrazumevane postavke. Kao rezultat toga, sva podešavanja će se vratiti na svoje podrazumevane pozicije.

Televizor će se automatski isključiti i uključiti nakon resetovanja.

Ako je Bezbednost uključena, morate da unesete lozinku da biste se vratili na podrazumevana podešavanja.

Ostavite napajanje uključeno dok se pokreće.

Pre nego što prodate ili date televizor nekom drugom, savetujemo vam da ga resetujete na fabrička podešavanja.

FOX LED TV

11 Tehnička specifikacija

Model proizvoda	75WOS630E	
Veličina ekrana	75" dijagonala	
Proporcija širine i visine	16:9	
Napajanje	AC 176-240V~,50/60Hz	
Potrošnja struje	320W	
TV sistem	PAL B/G D/K I,SECAM B/G D/K DVB-T/T2/C/S/S2 (opcija s/s2) (DVB-C signal je odsutan u nekim zemljama ili regionima.)	
Audio izlazna snaga (interna)	8Wx2	
Ulazni terminal	Antenski ulaz	x 2(S2 opcija)
	USB ulazni	x 2
	HDMI ulazni	x 3
	VGA ulazni	NE
	PC AUDIO ulazni	NE
	Audio ulazni (L/R)	x 1
	Video ulazni	x 1
	YPbPr ulazni	NE
	RJ45 ulazni	x 1
	Ulazni CI kartice	x 1
	SCART ulazni/izlazni	NE
	DC ulazni (12V)	NE
	Izlazni terminal	Slušalica
Audio linijski izlazni (L/R)		NE
Video izlazni		NE
Optički		x 1
Koaksijalni izlazni		NE
Radna temperatura	0°C~40°C	
Radna vlažnost	20% ~ 80% Bez kondenzacije	

Beleška: Gore navedene karakteristike su podložne promeni bez upozorenja u cilju poboljšanja kvaliteta.

FOX LED TV

12 Podržani režimi signala

A HDMI režim

Rezolucija	Horizontalna frekvencija (Khz)	Vertikalna frekvencija (Hz)
480p	31.468	59.94
576p	31.25	50.00
720P	45.00	60.00
1080i	33.75	60.00
1080P(1920x1080)	67.50	60.00
2160p(3840x2160)	67.50	30.00
2160p(3840x2160)	135.00	60.00

- Poruka upozorenja će se pojaviti na ekranu ako je signal koji ekran prima izvan dozvoljenog opsega.

-Na ekranu možete proveriti format ulaznog signala.

FOX LED TV

13 Jednostavno otklanjanje poteškoća

Ako ekran pokvari ili se njegove performanse drastično promene, proverite ekran u skladu sa smernicama u nastavku. Ne zaboravite da pregledate periferne uređaje kako biste identifikovali koren problema.

Simptom	Rešenje
Napajanje se ne može aktivirati. (Indikator napajanja ne svetli.)	-Potvrdite da su oba kraja kabla za napajanje pravilno umetnuta u utičnicu i da li je zidna utičnica funkcionalna.
Prikazuje se poruka Nema ulaznog signala.	- Proverite da li je signalna linija ispravno povezana. -Potvrdite da su relevantni periferni uređaji uključeni. -Uverite se da izabrani izbor ulaza odgovara ulaznom signalu.
Daljinski upravljač ne radi ispravno.	-Proverite da baterije nisu istrošene. (Koristite novu bateriju.) -Potvrdite da daljinski upravljač radi u svom dometu. - Uverite se da je daljinski upravljač usmeren ka prozoru daljinskog upravljača ekrana. - Uverite se da nema prepreka između daljinskog upravljača i njegovog prozora.
Na ekranu se nalaze trepćuće tačke ili pruge.	- Uverite se da nema emisija (auto, VN žice ili neonske sijalice) ili drugih potencijalnih izvora smetnji.
Boja ili kvalitet slike se pogoršavaju.	- Proverite da li su sva video podešavanja, kao što su osvetljenost, kontrast i boja, pravilno podešena. -Za dodatne informacije o video postavkama, pogledajte OSD funkcije poglavlja 2.
Položaj i veličina ekrana su netačni.	-Potvrdite da su pozicija i veličina ekrana na odgovarajući način.
Slika ili boja su netačne.	- Proverite da li je signalna linija ispravno povezana. -Kada ste povezani sa računarom, možete da promenite rezoluciju računara da biste dobili odgovarajuću sliku. Disparitet u izlaznom signalu računara može uticati na prikaz slike.
Prikažite poruku upozorenja.	- Proverite da li je ulazna linija signala na odgovarajući način obezbeđena. -Izaberite odgovarajući ulazni signal. -Pogledajte Podržani režimi signala u poglavlju 4 za dodatne



USER MANUAL

LED Television Model: 75WOS630E

Thank you for purchasing this device.

FOX LED televisions are known for their great performance, as for modern, functional and elegant design. Besides that, we constantly improve our customer support, we have highly efficient and wide network of services, that make our proud customers feel safe.

You made a right choice.



Now it's time for instructions, they are not complicated, but you have to follow them.

EN

IMPORTANT SAFETY INSTRUCTIONS

WARNING

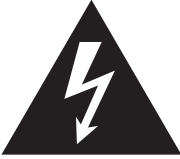
- TO PREVENT FIRE OR SHOCK HAZARD, DO NOT USE AN EXTENSION CORD, RECEPTACLE OR OTHER OUTLET UNLESS THE BLADES CAN BE TO PREVENT BLADE EXPOSURE.
- TO PREVENT FIRE OR SHOCK HAZARD, DO NOT EXPOSE THIS APPLIANCE TO RAIN OR MOISTURE.

 <p>This lightning flash with arrowhead symbol in an equilateral triangle alerts users to the presence of uninsulated dangerous voltage within the products enclosure that may be of sufficient magnitude to constitute a risk of electric shock.</p>	<h3>CAUTION</h3> <p>RISK OF ELECTRIC SHOCK DO NOT OPEN</p> <p>Warning: To reduce the risk of electric shock, do not remove cover (or back). No user serviceable parts inside. Refer servicing to qualified service personnel.</p>	 <p>The exclamation mark within an equilateral triangle alerts users to the presence of important operating and maintenance (servicing) instructions in the literature accompanying the appliance.</p>
--	--	---

This appliance should not be exposed to water and no object filled with liquid such as a vase should be placed on the unit.

CAUTION

- Danger of explosion if batteries are incorrectly replaced.
- Replace with only equivalent type of battery.
- Do not expose battery to direct sunlight or any other source of heat.
- Ensure proper disposal of used batteries.
- Where the MAINS plug or an appliance coupler is used as the disconnect device, the disconnect device shall remain readily operable.
- To reduce the risk of electric shock, do not perform any servicing other than what is mentioned in the operating manual.
- There are no user-serviceable parts inside the TV; do not open the TV casing.

IMPORTANT INFORMATION

If a television is not positioned in a sufficiently stable location, it can be potentially hazardous due to falling. Many injuries, particularly to children, can be avoided by taking simple precautions such as:

- Using cabinets or stands recommended by the manufacturer of the television.
- Only using furniture that can safely support the television.
- Ensuring the television is not overhanging the edge of the supporting furniture.
- Not placing the television on tall furniture (for example, cupboards or bookcases) without anchoring both the furniture and the television to a suitable support.
- Not standing the televisions on cloth or other materials placed between the television and supporting furniture.
- Educating children about the dangers of climbing on furniture to reach the television or its controls.



Safe installation

Use the belt fixing the television to facilitate restraining the television from toping forward.



1. **Read Instructions** - All the safety and operating instructions should be read before the appliance is operated.
2. **Retain Instructions** - The safety and operating instructions should be retained for future reference.
3. **Heed Warnings** - All warnings on the appliance and in the operating instructions should be adhered to.
4. **Follow Instructions** - All operating instructions should be followed.



5. **Water and Moisture** - The appliance should not be used near water.
6. **Cart and Stands** - The appliance should only be used with a cart or stand that is recommended by the manufacturer.
7. **Wall or Ceiling Mounting** - The appliance should be mounted to a wall or ceiling only as recommended by the manufacturer.
8. **Ventilation** - The appliance should be well situated so that its location or position does not interfere with its proper ventilation.
9. **Heat** - This appliance should be placed away from heat sources such as radiators, heat registers and stoves.
10. **Power Sources** - The appliance should only be connected to a power supply as described in the operating instructions or as marked on the appliance.
11. **Grounding or Polarization** - Precautions should be taken.
12. **Power Cord Protection** - Power supply cord should be routed so that it is not likely to be walked on, pinched by items placed upon it against the cord and its end.
13. **Cleaning** - The appliance should be cleaned only as recommended by the manufacturer.
14. **Power Line** - An outdoor antenna should be located away from power lines.
15. **Outdoor Antenna Grounding** - If an outside antenna is connected to the receiver, the antenna system must be grounded so as to provide against voltages and built-up static charges.
16. **Non-use Periods** - The power cord of the appliance should be unplugged from the outlet when left unused for a long period of time.
17. **Object and Liquid Entry** - Care should be taken so that objects did not fall, and liquids are not spilled into the enclosure through openings.
18. **Conditions requiring Service** - The appliance should be serviced by qualified service personnel when:
 - The power-supply cord or the plug has been damaged.
 - Objects have fallen on or liquid has been spilled into the appliance.
 - The appliance has been exposed to rain.
 - The appliance does not appear to operate normally or exhibits a marked change in performance.
19. The ventilation should not be impeded by covering the ventilation opening with items, such as newspapers, table-cloths,curtains,etc.
 No naked flame sources, such as lighted candles, should be placed on the apparatus.
 The apparatus shall be connected to mains socket outlet with a protective earthing connection.
 The appliance coupler regard as disconnection device, the disconnect device shall remain readily operable.

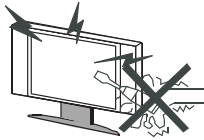

Warning

High voltages are used in the operating of this product. Do not remove the back cover of the cabinet. Refer servicing to qualified service personnel.

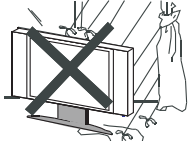

Warning

To prevent fire or electrical shock hazard, do not expose the main unit to rain or moisture.



Warning

Do not drop or push objects into television cabinet slots or openings. Never spill any kind of liquid on the television receiver.

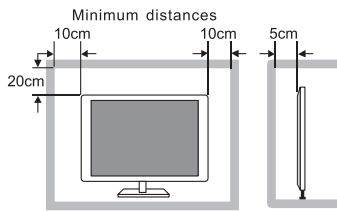

Caution

If the television is to be built into a compartment or similarly enclosed, the minimum distances must be maintained.

Heat built up can reduce the service life of your television, and can also be dangerous.



Caution

Never stand on, lean on, push suddenly the product or its stand.

You should pay special attention to children.

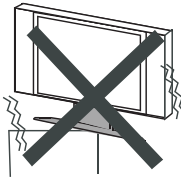

Caution

Do not place the main unit on an unstable cart stand, shelf or table.

Serious injury to an individual, and damage to the television, may result should it fall.

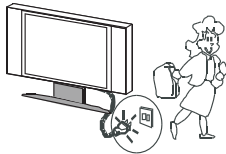

Caution

When the product is not used for an extended period of time, it is advisable to disconnect the AC power cord from the AC outlet.

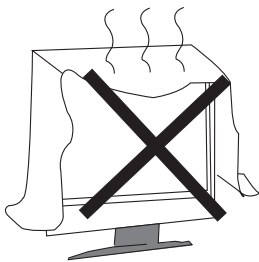

Caution

Avoid exposing the main unit to direct sunlight and other sources of heat. Do not position television receiver directly on other products which give off heat. E.g. Video cassette players, audio amplifiers. Do not block the ventilation holes in the back cover. Ventilation is essential to prevent electrical failure. Do not squash power supply cord under the main unit.



Caution

The panel used in this product is made of glass. It can break when the product is dropped or applied with force. Individuals should execute caution when dealing with broken glass should the panel break.



- Place the TV on a firm and flat surface, leaving a space of at least 10cm around the set and 30cm from the top of the set to the wall or cabinet. Ensure the TV is positioned close to the wall to avoid it falling when pushed.

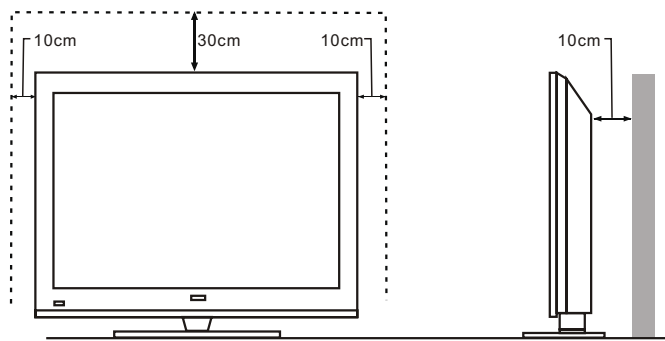

- When you turning the TV set, do not hold the top side of the TV set, you should hold the bottom side.

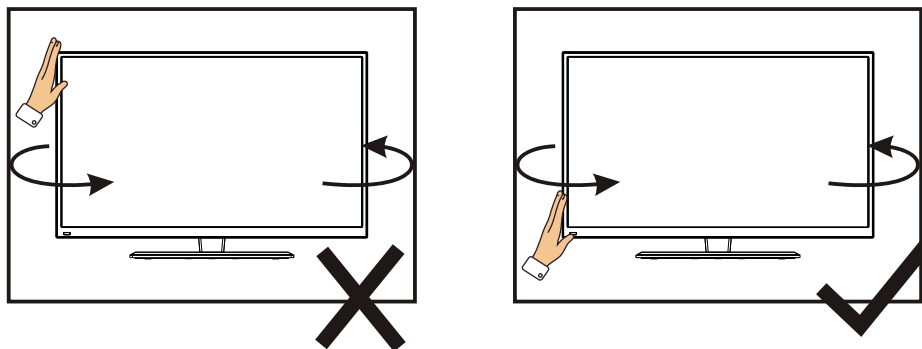

- When you lifting the TV set, do not use one hand to handle it, you should lift the TV set by two hands.

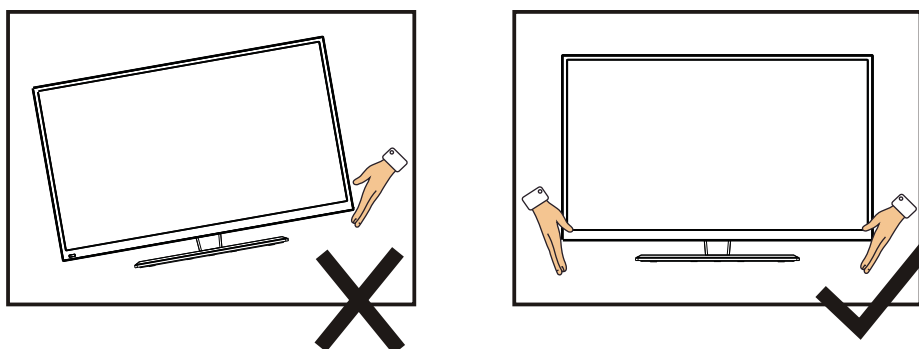

CONTENTS

1. Connection and Preparation of TV.....	2
1.1 Accessories	2
1.2 Installation of Stand.....	2
1.3 Keys and Interfaces.....	3
1.4 Remote Control.....	4
1.5 Installation of Batteries.....	5
2. Basic Operation.....	5
2.1 Power ON/OFF(Optional).....	5
2.2 Setting of Standby Mode.....	5
3. Boot Wizard	6
4. Enjoy Live TV	7
5. Getting Started with webOS TV.....	8
6. How to Operate TV	13
6. ENJOYING CONTENT STORE.....	15
7. CONNECTING EXTERNAL DEVICES	17
8. MAKING THE MOST OF SMART TV	21
9. SETTINGS	21
10. Technical Specification.....	39
11. Supported Signal Modes.....	40
12. Simple Troubleshooting	41

1.Connection and Preparation of TV

1.1 Accessories

- ★ User Manual
- ★ Remote Control
- ★ Battery(UM-4/R03P/AAA)
- ★ Wall Mount Kit (Pre-assembled)(Optional)

1.2 Installation of Stand

(For the physical structure, please refer to the real object)

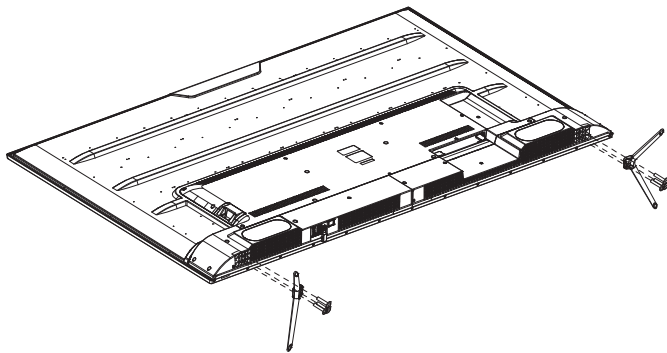

- ① Place the TV with the front panel facing downwards on the soft cloth or soft pads on a desk.
- ② Insert the stand into the bottom socket of the TV.
- ③ Insert the screws into the sockets and tighten them.

1.3 Keys and Interfaces

The design and specification takes actual products as the standard

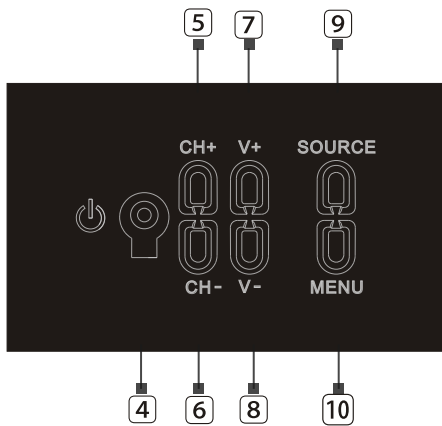
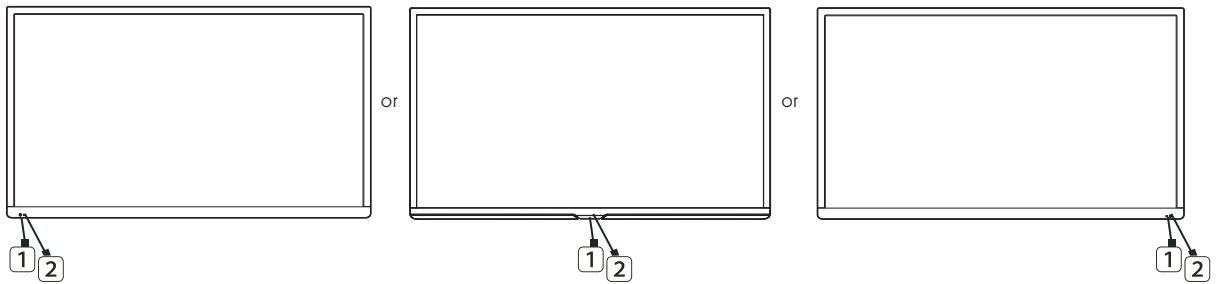

- 1. Remote sensor window
- 2. Power indicator
- 3. Speaker
- 4. Standby key
- 5. CH “+” key
- 6. CH “-” key
- 7. Volume “+” key
- 8. Volume “-” key
- 9. SOURCE key
- 10. Menu key
- 11. POWERPLUG INPUT

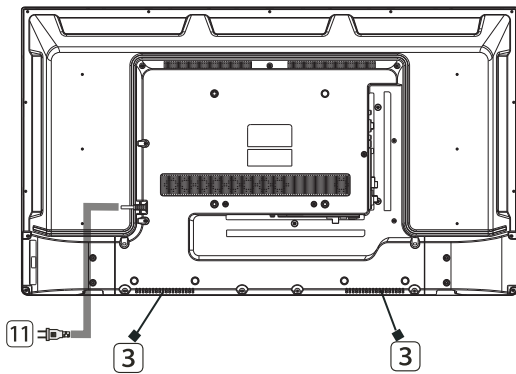

OPTICAL	HDMI2 (ARC)	HDMI1	USB1 5V==500mA	CI			
USB2 5V==500mA	RJ45	VIDEO	AV IN L R	EARPHONE	HDMI3	RF IN (S2) 13V/18V==500mA	RF IN (T2)

1.4 Remote Control

(Here is only the sketch, please in kind prevail)



For buttons with #, please long-press (hold for more than a second).

POWER: ON/OFF.

(STB POWER) You can turn on/off the power of the set-top box.

0-9: Number selection key.

0# : The QUICK ACCESS edit screen appears.

LIST: Checking the saved programmes.

... : It displays the additional buttons on the remote control.

...# : Audibly describes the contents of the screen.

: It adjusts the volume level.

: Select to turn off the sound from the TV.

: Enter the Accessibility menu.

: You can change the programme.

: Check out the recommended contents. (Recommendation service may not be available depending on the countries you are in.)

Push and hold the button while speaking to use the voice recognition function.

: Displays the Home menu.

: Displays the list used previously.

: Enters the Quick Settings menu.

: Enters the All Settings menu.

Wheel (OK) : Press the center of the Wheel button to select a menu. You can change channels by using the wheel button.

(up/down/left/right) Press the up, down, left or right button to scroll the menu. If you press buttons while the pointer is in use, the pointer will disappear from the screen and Magic Remote will operate like a general remote control. To display the pointer on the screen again, shake Magic Remote the left and right.

: Move to the previous step.

: Closes the menu.

GUIDE : You can check the programme.

NETFLIX : go to Netflix.

: Selects an input source.

: Entering into the Home Dashboard.

: go to prime video.

, , , These access special functions in some menus.

MOVIES : Search Movies.

: Play.

: Pause.

1.5 Installation of Batteries

(Here is only the sketch, please in kind prevail)

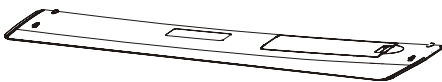
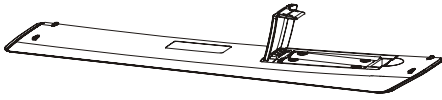

- ① Open the back lid of the remote control.
- ② Install two 7#(AAA)1.5V batteries.
Ensure the correct polarity of the batteries.
- ③ Cover the back lid.
Please take out of the batteries from the remote control for long time of no use.

If the remote control doesn't work properly, please carry out the following checks.

- Check the TV is turned on.
- Check the polarity of the batteries are correct.
- Check the batteries are not drained.
- Check the power supply is normal or the power cord is correctly connected.
- Check there are no special fluorescent light or neon light around.



2. Basic Operation

2.1 Power ON/OFF(Optional)

- Connect the power cord to the **AC input**. Insert the power cord into the appropriate socket.
- Press the **Power switch** to switch on the TV, then press **Power** button to turn on the unit.
- Press the **Power switch** again to switch off the TV.

Note: After switch off the TV, please don't immediately re-open the power switch, should be delayed one minute more to re-open the power switch.

2.2 Setting of Standby Mode

- Press () button to turn on the unit.
- Press () button again to return the display to standby mode. The power indicator turns red.
- Be sure not to set your TV in standby mode for a long period of time.

3.Boot Wizard

Press the OK button(wheel)on your remote.



Confirm your location and language settings.

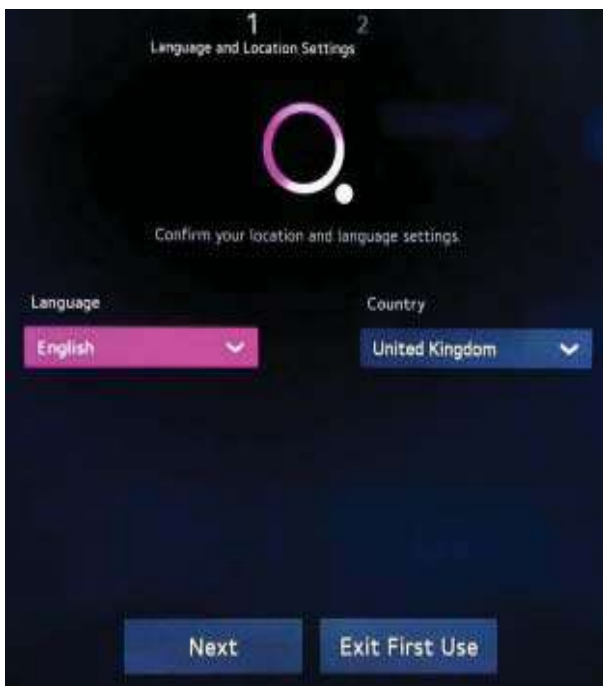

Press the Exit First Use,enter TV mode.

Press the Next,Please press the wizard to continue to set up network connection and other operations.

4. Enjoy Live TV

Making the Most of Live Menu

Using Live Menu

You can use the relevant features with ease when watching TV broadcasts.

Press the LIST button on the remote control.

Or press the Wheel (OK) button on the remote control and select Programmes.



1. Programmes : View a list of broadcast content that is currently being broadcast.

2. Guide : You can view programmes and the schedule of each programmes.

To see the details, click the Enjoy Live TV → Viewing Guide in User Guide.

3. TV Scheduler : You can enter the time and date of a programme to schedule watching or recording it at the set time.

To see the details, click the Enjoy Live TV → Using TV Scheduler in User Guide.

4. Recordings : You can check the recordings stored in the storage device and play the recordings.

To see the details, click the Enjoy Live TV → Playing Recorded TV Programs in User Guide.

The menu appears only if an external storage device is connected and the recorded video can be viewed.

The programmes displayed in Programme List are a configuration of programmes provided by the broadcast service provider. Therefore, if the broadcast service provider has changed its programme configuration without notice, the programmes displayed in Programme List may differ from the actual TV programmes.

Because programme information displayed in programme List includes information provided by external Electronic Programme Guide (EPG) providers, it may differ from the actual TV programmes.

You must complete the settings of the network, region, and auto-programme to receive normal live broadcast service.

The configurable items differ depending on model

5. Getting Started with webOS TV

Home Tutorial

Using the Home Feature of the webOS TV

You can open the Home screen by pressing the  button on your remote control. You can combine frequently used apps on a single screen and use whichever you want at any time.



1.Launch Search.

To see the details, click the Enjoying Content Store Content Search in User Guide.

2.Move to the Home Dashboard.

You can select or control a device (mobile, external device, Home IoT Devices, etc.) connected to the TV.

For more information, see Connecting External Devices Using Home Dashboard in User Guide.

3.Move to the TV input you used recently.

4.Move to the recently used app.

Long-press the  button on the remote control or focus on the Recents.



You can run or close a recently used app in the list provided in the Preview area at the top.

5.You can run, move, and delete the apps installed on your TV.

Focus on each App area. It provides the Preview at the top.

You can check or run useful features of each app and recommended content on the Preview without entering into the app.

Some apps may not provide the Preview.

The home screen will be displayed automatically when the TV is turned on. If you don't want the home screen to be displayed, set Home Auto Launch of  →  → General → Home Settings as Off.

The availability of and access to Contents and Services in device are subject to change at any time without prior notice.

Getting Started with webOS TV

Manage Home

Manage webOS TV Home

You can view a list of all apps installed on your TV, change their positions, or delete them.

1. Select the app you want to edit, and press and hold the Wheel (OK) button on the remote control.

This will activate the app edit mode.

Or you can select the Edit mode button at the right corner of the Home list to enter the App Edit mode.

2. To move the app to your desired position, go to the position and press the Wheel (OK) button.

To delete an app, select the App Delete icon above the app.

You can move and delete as many apps as you wish before exiting the edit mode.

You can also move apps with the ◀/▶ buttons on your remote control.

3. After the editing is done, press the Close at the top right to exit the App Edit mode.

The default TV app cannot be edited.

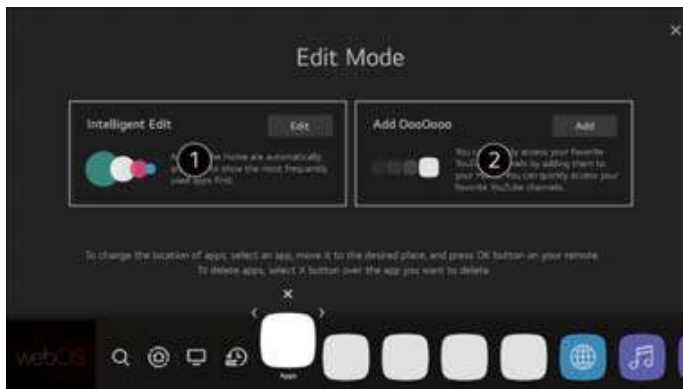

1. You can automatically arrange the app list in the order of most frequently used based on your accumulated app usage pattern.

2. You can add your favourite video service programme to the list.

This feature is available only when the network is connected.

Some models may not be supported.

Live TV Preparation

1. Connect the broadcast antenna to the TV.

You can also connect a piece of equipment that can receive broadcasting such as a set-top box instead of the antenna.

Launch ⚙️ → ⋮ → Connection → Device Connection Settings → Universal Control Settings

2. Start the ⚙️ → ⋮ → Programmes Programme Tuning (Programme Tuning & Settings) Auto Tuning.

Finds and adds only programmes being broadcast.

To solve a problem related to this function, refer to the Troubleshooting section of User Guide.

Getting Started with webOS TV

Connecting to the Network

Connecting to the Network

If you configure settings for the network, you can use various services such as online contents and applications.

Setting a Wired Network

1. Connect the LAN port of the TV and the router using a LAN cable.

The router should be connected to the Internet beforehand.

If the router supports DHCP, the TV is automatically connected to the network when you connect the TV to the network with a LAN cable.

If the Network Is Not Automatically Connected

2. Press the  button on the remote control.

3. Select  → Connection → Network Connection Settings

Wired Connection (Ethernet).

To see the details, click the Settings → Connection → Network Connection Settings in User Guide

Setting a Wireless Network

1. Turn on the power of the router connected to the Internet.

2. Press the Settings button on the remote control.

3. Select All Settings icon → Connection → Network → Connection Settings → Wi-Fi Connection.

4. When the network search is complete, the list of networks available for connection is shown.

5. Select a network to connect.

If your wireless LAN router is password protected, enter the password configured for the router.

To see the details, click the Settings → Connection → Network Connection Settings in User Guide.

Getting Started with webOS TV

Connecting to the Network

Network Setting Warnings

1. Use standard LAN cable (connect to Cat7 or higher with RJ45 connector, 10 Base-T, or 100 Base TX LAN port).
2. Resetting the modem may fix some network connection problems. Turn the power OFF, disconnect and reconnect it, and then turn the power on to solve the problem.
3. The manufacturer is not responsible for any network connection problems or any faults, malfunctions, or errors caused by network connection.
4. The network connection may not work properly because of network settings or the Internet service provider.
5. DSL service must use a DSL modem; and cable service must use a cable modem. Since only a limited number of network connections may be available, TV network setting may not be used depending on the contract with Internet service provider. (If the contract does not allow more than one device per line, only the already-connected PC may be used.)
6. A wireless network can experience interference from other devices that use the 2.4 GHz frequency (wireless phone, Bluetooth device, or microwave oven). Although interference can also happen when using the 5 GHz frequency, it is less likely to occur.
7. The wireless environment can make wireless network service run slowly. Failure to turn off all local home networks may cause excessive traffic on some devices. The access point device must support wireless connections and wireless connection feature must be enabled on the device to have AP (access point) connection. Contact the service provider for availability of wireless connections on the access point.
8. Check SSID and security settings of the AP. Refer to the appropriate documentation for SSID and security settings of the AP.
9. Invalid settings of network devices (wired/wireless line sharer, hub) can cause the TV to operate slowly or not operate properly. Install the devices correctly according to the appropriate manual and network.
10. The connection method may differ depending on the AP manufacturer.
11. To solve a problem related to this function, refer to the Troubleshooting section of User Guide

Getting Started with webOS TV

Managing Your LG Account

Creating LG Account

In Account Management, you can use your email address to create a new LG account. Alternatively, you can create and log in to an LG account using the ID and password of an external service account.

Press the  button on the remote control.

Select  → General → Account Management → LG Account Sign In.

Select Create Account. Read and accept the Terms of Service.

Enter ID and password. Your ID must be your email address.

Enter your date of birth.

If you select OK, a verification link is sent to the email address you entered. Please complete the email verification within the validity period.

If email verification is successful, an LG account is created and you can log in with this account information.

Some models may not be supported.

Internet connection is required to create an account.

Required information may vary depending on the country.

You may be restricted from the service depending on your age.

To solve a problem related to this function, refer to the Troubleshooting section of User Guide.

Managing Your LG Account

You can manage the information of your LG account.

Press the  button on the remote control.

Go to  → General → Account Management to log in.

Personal Information

You can view or edit your information of the account currently logged in.

You can change the password or press Edit to edit your personal information.

Some models may not be supported.



6.How to Operate TV

Connecting to SIMPLINK (HDMI-CEC)

Using SIMPLINK

With a single remote control, you can easily manage various devices such as a soundbar or set-top box connected to a TV with HDMI.

Up to three devices can be connected and used simultaneously.

- 1.Connect the SIMPLINK HDMI Output port to the TV HDMI IN port with an HDMI cable.
- 2.Press the  button on the remote control.
- 3.Select  → Connection → Device Connection Settings.
- 4.Set SIMPLINK (HDMI-CEC) to On.
- 5.Configure the Auto Power Sync settings to On or Off. (If Auto Power Sync is set to On, turning on a SIMPLINK-linked device will turn the TV on. When you turn off the TV, the device will also be turned off.)
- 6.Turn on the connected device. When the TV automatically connects to the device, the input will change.

If the device is not automatically connected to the TV, click the Input button.

This feature works only with devices with the SIMPLINK logo. Check for the SIMPLINK logo on the external device.

Use of any product other than those specified may cause problems during operation.

To use Simplink, you need to use a high-speed HDMI cable with CEC (Consumer Electronics Control) function. The High-Speed HDMI cable has the pin 13 for enabling information exchange between devices.

If you want to output sound to the external audio equipment connected through the HDMI cable, set SIMPLINK (HDMI-CEC) to On

How to Operate TV

Supported SIMPLINK Functions

Instant Play

When you start a multimedia device, you can immediately watch content from the device on the TV without having to control anything.

Controlling devices with the TV remote control

Enables the user to control multimedia devices with the TV remote control to watch content. The pointer function of the Magic remote can be limited.

Main Power Off

If Auto Power Sync is set to On in the Device Connection Settings and turn off your TV, the devices connected to your TV via SIMPLINK will also be turned off.

This feature is only available in certain devices.

Main Power On

If Auto Power Sync is set to On in the Device Connection Settings, turning on a SIMPLINK-linked device will turn the TV on.

If SIMPLINK (HDMI-CEC) is set to Off, Auto Power Sync can not set to On.

Some models may not be supported.

Shortcuts to Accessibility

Shortcuts to Accessibility

You may go directly to Accessibility without entering the Advanced Settings menu.

Press and hold the MUTE button on your remote control.

You can set High Contrast, Grayscale, Invert Colours, etc.

7. ENJOYING CONTENT STORE

Home Tutorial

Using Content Store

You can download and use apps from various categories such as education, entertainment, lifestyle, news, and games.

Press the HOME button on the remote control.

Launch Content Store.

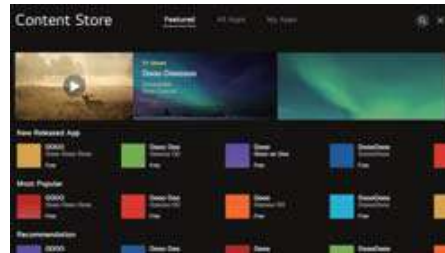

Depending on the model, the provided contents may differ or some features may be limited. Exercise caution when in use by children. Children may have access to inappropriate online content through this product. You can block inappropriate online content by restricting access to some apps.

Configure the settings in  →  → General → Safety → Application Locks.

Installing Apps

You can install various apps on your TV from the Content Store.

1. Press the  button on the remote control.
2. Launch Content Store.
3. Select All Apps category shown at the top of the screen.
The list of available apps in the selected category will be shown.
4. Select an app to set up from the list.
5. Read the details of the app and then press Install.
6. When the installation is complete, you can run the app immediately.

Available categories may vary depending on the country or service status.

If the storage on your TV is insufficient, you can install the apps by connecting an external memory device.

Some USB storage devices may not be supported or may not work properly.

USB stick containing apps from other TVs may not be used.

You can delete apps you have downloaded in My Apps.

ENJOYING CONTENT STORE

Content Recommendation

You can get content recommendations based on the programme you are watching or TV viewing patterns.

If you are watching the TV using a set-top box, you must complete the setup of the universal remote control to use the recommendation feature normally. For more information, see *How to Operate TV→Using Universal Remote Control* in User Guide.

Press the  button on the remote control.

Launch Search

Some models may not be supported.

You must connect to the network to use the recommendation feature.

The supported services vary depending on countries, so the recommendations may be provided differently.

The list of the recommendations may be less relevant or irrelevant, depending on the information of the programme you are watching.

Content Search

Content Search

You can receive recommendations for content based on viewing patterns or search by yourself for the content you want.

Press the  button on the remote control.

Launch Search.

Search for a variety of content and information using the desired search terms.

Returns to the previous screen.

Provides a list of content for the selected genre.

Enter a search term.

Exit the Search.

You must connect to the network to use the search feature.

Search results may vary depending on the programme, region, network settings, and whether you have agreed to the terms and conditions.

8.CONNECTING EXTERNAL DEVICES

Using Home Dashboard

Using Home Dashboard

You can select or control a device (mobile, external device, Home IoT Devices, etc.) connected to the TV.

Press the  button on the remote control and select Home Dashboard.

You can also press and hold the  button on the remote control.



You can check and select the smart device connected with the LG ThinQ app.

Please refer to Connecting External Devices Connecting Smart Devices in User Guide for more information on the action.

You can play sound from a smart device connected via Bluetooth.

Please refer to Connecting External Devices Playing Sound from a Smart Device through the TV's Speakers in User Guide for more information on the action.

You can check and select the external device connected through the external input port or network. The currently selected output speaker is displayed, and you can navigate to the output speaker settings screen.

You can view and select the connected storage device.

You can check and control the device connected via the Home IoT.

Please refer to Connecting External Devices Connecting Home IoT Devices in User Guide for more information on the action.

You can easily control your device by presetting the desired operations.

Sign In : You can log in/out to and from the LG ThinQ account you created on mobile.

Edit : You can edit the name of the device connected to Inputs or Home IoT Devices or configure the related settings.

It refreshes the device list.

Exit the Home Dashboard.



Available settings vary depending on the model or region

CONNECTING EXTERNAL DEVICES

Connecting Home IoT Devices

Connecting Home IoT Devices

You can check and control the status of the connected Home IoT Devices.

1. Install LG ThinQ app on your smartphone.
2. Log in to your LG ThinQ account, and register your own LG ThinQ device.
3. Press the  button on the remote control and select Home Dashboard.
4. Press the  at the top right to select the Sign In.
5. Log in to your LG ThinQ account. A list of the registered LG ThinQ devices will appear.

If you are in an area where the LG ThinQ app is not in service, LG ThinQ device connection will not be supported.

If you are controlling the external device from your mobile app, you might not be able to control the device from your TV. Quit the mobile app to control it from your TV.

1. You can easily control your device by presetting the desired operations.
2. You can log in/out to and from the LG ThinQ account you created on mobile.
3. Edit List : You can rename, Show/Hide or change the order of the devices connected to Home IoT Devices.

Notification : If you turn it On, you can receive notifications about the status of the Home IoT Devices.

Delete : You can delete the connected device. You can only delete certain devices from the TV.

4. You can check the connection guide for Home IoT Devices. You can connect and display the devices registered to your LG ThinQ account.

Once the device is connected, the card will be changed to a smaller size and appear at the bottom of the device connection list.

Available settings vary depending on the model or region.

IoT devices that can be connected to a TV are subject to change without notice.

Connectable LG ThinQ devices and available functions may differ between mobile and TV

Connecting Smart Devices

You can use a variety of features by connecting the TV to a smart device.

Connecting Your Smart Device to a TV Using the LG ThinQ App



1. Download the LG ThinQ app from the app store of your smart device.

You can download the app easily by scanning the QR code



CONNECTING EXTERNAL DEVICES

Connect your TV and smart device to the same Wi-Fi network.

You can check the Wi-Fi network of TV at  →  → Connection → Network Connection Settings → Wi-Fi Connection.

Run the LG ThinQ app installed on your smart device.

Follow the instructions from LG ThinQ app to connect your smart device to the TV.

When your account information of LG ThinQ is linked to the TV, you can manage the IoT devices linked to your account using Home Dashboard of the TV.

Controlling Your TV with the LG ThinQ App

You can tap the buttons on your smart device's screen to control the TV.

1. When watching a broadcast, you can control the programme, volume, etc. or select the external input with voice commands instead of using the remote control.

2. You can use the same functions as the Magic Remote's pointer and arrow keys.

Some controls may be limited in external input mode.

The app's screen and functionality are subject to change without prior notice.

Available features may differ depending on your country and OS.

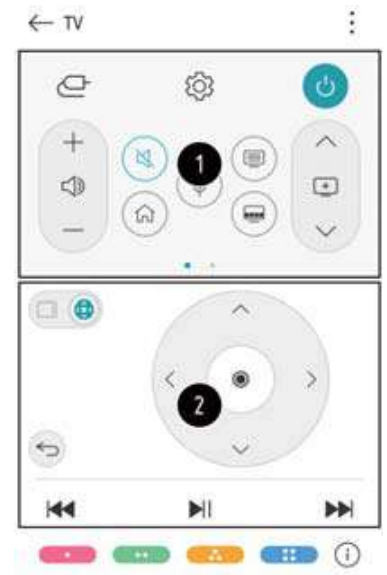

Watching Smart Device Screen on TV

To See the Mobile Device's Screen on the TV

Enable Screen Share mode on the mobile device.

Your TV will be displayed in the list of available devices.

Select your TV and request connection.

Select Accept in the connection request popup window.



After the connection is established, the TV will display the screen of the connected device.

When you connect Screen Share for the first time, a popup will appear which allows you to select Decline, Accept or Block.

Decline : Do not connect the device. If you try to connect again, the popup will appear.

Accept : You can connect the device. No connection popup will appear from the second time.

Block : Do not connect the device. Even if you try to connect again, the popup will not appear and the connection will not work.

To cancel Block, go to  →  → Connection → Mobile Connection Management → Screen Share.

It is recommended that you always update your device to be connected to your TV to the latest OS version for a reliable connection.

A non-LGE device may not be connected even when it is detected.

It is recommended that you connect the device to a 5 GHz router because the performance may be affected by your wireless environment.

The response rate may vary depending on the user's environment.

It's differ form devices. For more information on the device you want to connect to, refer to its user guide.

If connection fails repeatedly, turn off the TV and the device you want to connect to, then turn them back on and try again.

CONNECTING EXTERNAL DEVICES

Playing Sound from a Smart Device through the TV's Speakers

Playing Sound from a Smart Device through the TV's Speakers

Connect a smart device to the TV via Bluetooth to play sound from the smart device through the TV's speakers.

1. Turn the smart device's Bluetooth on, then select the TV from the list of devices.
2. The TV will be connected to the smart device.

If the output speaker is set to Bluetooth or has a setup history, the TV may not be detected in the list of smart devices.

If the output speaker is set to Bluetooth, press and hold the Input select button on the remote control to launch Home Dashboard, and then select Sound Share in the Mobile area to connect.

Connecting USB

Connecting USB

Connect a USB storage device (USB HDD, USB stick) to the USB port on the TV to enjoy the content files stored on the USB storage device on your TV.

Tips for Using a USB Storage Device

A USB storage device that has a built-in automatic recognition programme or uses its own driver might not be recognisable.

Some USB storage devices may not be supported or may not work properly.

Viewing Photos and Videos

Viewing Photos and Videos

You can view photos and videos using the Photo & Video app.

1. Press the  button on the remote control.
2. Run the Photo & Video app.
3. Select your desired storage device.
4. Select and view your desired photo or video.

Listening to Music

Playing Music

1. You can listen to music by using the Music app.

Press the HOME button on the remote control.

2. Run the Music app.
3. Select your desired storage device.

You can select your desired songs from all of your storage devices and add them to My Playlist.

4. Select your desired music content and enjoy it.

9. MAKING THE MOST OF SMART TV

Surfing the Internet on TV

Using the Web Browser

You can enter the website when you input the web address on the URL bar.

If you input the search word, it will find the information about search word base on the search engine.

Press the  button on the remote control.

Run the Web Browser application.

1. You can refresh the web page you are viewing.
2. You can type in a web address to navigate to a specific website or enter a search term directly.
3. You can view the tabs that are currently open.
4. You can block ads within the web page you are viewing.

However, this button is only displayed if Menu icons Settings Use Block Ads feature is set to On.

5. Split the screen to display the TV screen. You can browse web pages while watching TV.

6. You can zoom in or out on the screen while browsing the website.

Add to bookmarks : You can add the website you are currently viewing to your Favourites.

History : You can view and delete the website visit history.

Bookmarks : You can view and delete the list of websites you have added to your Favourites.

Settings : You can change the web browser settings.

7. Exit the Web Browser.

8. The new tab screen shows a list of Recommended Sites and Most Visited Sites.

If you do not want Recommended Sites to be displayed, set Menu icons Settings Show Recommended Sites to Off.

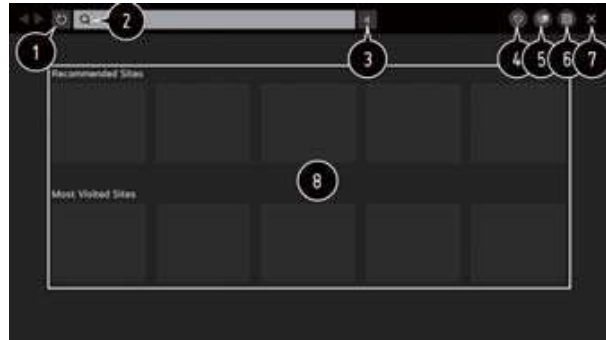

10. SETTINGS

Quick Settings

To Use Setting Function Quickly

Set of light-weight controls quickly and simply such as Picture Mode, Sound Out, Sleep Timer and so on.

Press the  button on the remote control.

You can set Picture Mode.

You can set Sound Mode.

You can choose Sound Out.

You can set Sleep Timer.

Move to the Connection screen.

You can set more options.

You can add/delete the quick setting items or change their order.

After entering each item, press and hold the Wheel (OK) button on the remote control to go to the corresponding menu.



SETTINGS

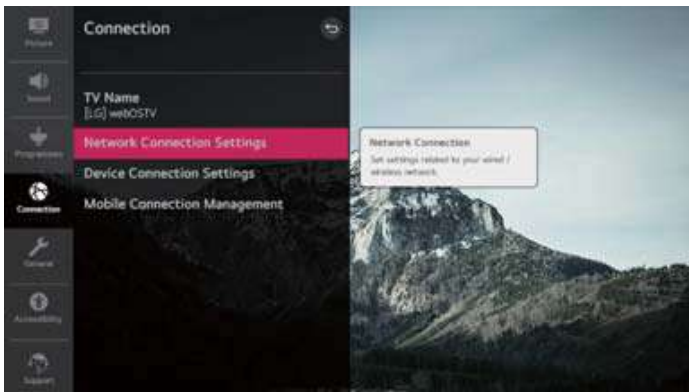

Picture

Picture Mode

Selecting Picture Mode

⚙️ → ⋮ → Picture → Picture Mode Settings → Picture Mode

Select the picture mode that is best suited to your viewing environment, preferences or video type.

Select a picture mode. By adjusting and setting each item in more detail based on the mode, your video is better optimised for its characteristics.

The configurable items differ depending on model.

When You Use Normal Signals

Vivid

Sharpens the image by increasing the contrast, brightness and sharpness.

Eco / APS

The Energy Saver feature changes settings on the TV to reduce power consumption.

The configurable items differ depending on model.

Cinema

Suitable picture for movies.

Sports / Football / Cricket

Suitable picture for sports games. Sharpens the image of rapid movements such as kicking or throwing a ball.

The name of the sport may differ depending on region.

Game

Suitable picture for gameplay.

When You Use the HDR Signals

Vivid

Sharpens the image by increasing the contrast, brightness and sharpness.

Standard

In a normal viewing environment, it opens a screen that can properly show the expressiveness and brightness of HDR.

Cinema

Suitable picture for HDR video signal.

SETTINGS

Game

Suitable picture for gameplay.

Depending on the input signal, the available picture modes may be different.



When watching online service content, the Picture Mode may be changed to match the content being shown.

Picture Mode change may modify Energy Saving settings and it can affect energy consumption.

You can adjust their settings manually in the Energy Saving menu.

Picture Mode Settings

Fine-Tuning Picture Mode

 →  → Picture → Picture Mode Settings

This feature allows you to adjust the selected picture mode in detail.

Backlight

Controls the level of screen brightness by adjusting the backlight. The closer to 100, the brighter the screen.

Decrease the Backlight to reduce energy consumption.

If the Energy Saving is set to Maximum, you cannot adjust the Backlight.

In this case, navigate to  →  → Picture → Energy Saving and set to Off or Minimum.

Contrast

Adjusts the contrast of the bright and dark areas of the picture. The closer to 100, the higher the contrast.

Brightness

Adjusts the overall screen brightness. The closer to 100, the brighter the screen.

You may use the Brightness settings particularly to set the dark part of the image.

Sharpness

Adjusts the sharpness of the image. The closer to 50, the sharper and clearer the image.

Colour

Tones down or up the colours displayed on the screen. The closer to 100, the deeper the colour.

Tint

Adjusts the colour balance between red and green displayed on the screen. The closer to Red 50, the more red the colour will be. The closer to Green 50, the more green the colour will be.

Colour Temperature

Adjusts the colour tone of the entire image. As you lower the level, you get a warmer tone, and as you raise it, you get a cooler tone.

The settings you specify only apply to the currently selected input mode.

To apply your current picture settings to all input modes, select Apply to all inputs.

Depending on the input signal or the selected picture mode, the available options may differ.

The configurable items differ depending on model.



Resetting Picture Mode

 →  → Picture → Picture Mode Settings → Reset

If you want to reset the image settings to the factory defaults after configuring the image settings, select reset for each image mode.

Advanced Controls

Setting the Advanced Control Options

 →  → Picture → Picture Mode Settings → Advanced Controls

Dynamic Contrast

Corrects the difference between the bright and dark sides of the screen for optimal results depending on the brightness of the picture.

SETTINGS

Dynamic Colour

Adjusts the Colour and saturation of the picture to make the image more Colourful and lively.

Gamma

Adjusts the medium brightness of the picture.

Select Low for a bright picture, select High1 or High2 for a dark picture or select Medium for medium brightness.

Live Theatre or Expert (Bright Room)/Expert (Dark Room) can be selected from 1.9/2.2/2.4/BT.1886. High2/BT.1886 expresses the gradation in ITU-R BT.1886, which is an international standard.

Depending on the input signal or the selected picture mode, the available options may differ.

Picture Options

Setting Picture Options

 →  Picture → Picture Mode Settings → Picture Options

Noise Reduction

Removes small dots that stand out so as to make the image clean.

Black Level

Adjusts the brightness of the dark parts of images.

Select High for a bright screen or select Low for a dark screen.

This feature can be used while watching content through an external input.

Real Cinema

Optimise display for movies.

TruMotion

Suitable the image quality of fast-moving pictures.

Off : Turns off the TruMotion.

Cinema Clear : Adjusts the shaking of the motion on the screen to make it feel like you are in a movie theatre.

Natural : Sets images with a lot of motions to look natural and clear.

Smooth : Softens fast-moving pictures.

User : Sets TruMotion manually.

De-Judder : Adjusts juddering on the screen.

De-Blur : Reduces the blurring effects of motion.

Motion Pro : Make fast-moving pictures clearer using the light control.

The advanced settings can be changed only in User mode.

Depending on the input signal or the selected picture mode, the available options may differ.

The configurable items differ depending on model.

Aspect Ratio Settings

Setting the Screen Size

 →  → Picture → Aspect Ratio Settings → Aspect Ratio

You can change the screen size according to the type of content you are watching.

View Screen with Just Scan

 →  → Picture → Aspect Ratio Settings → Just Scan

If you turn this feature On, you can view the content in the aspect ratio that is in the broadcast signal or content source. If the edge of the screen is not clean, please turn it Off.

If set to Auto, the feature switches between On or Off status depending on the information contained in the video signal.

The items that can be selected may vary depending on the current input.

SETTINGS

Energy Saving

To Use Energy Saving Feature

 →  → Picture → Energy Saving

Reduces power consumption by adjusting screen brightness.

Off

Turns off the Energy Saving mode.

Minimum / Medium / Maximum

Applies the pre-set Energy Saving mode.

Screen Off



Screen is turned off and only sound is played.

Press any button except the power and the volume buttons to turn the screen back on.

If you use Energy Saving function, brightness of your TV will be affected.

Eye Comfort Mode

To Use Eye Comfort Mode Feature

 →  → Picture → Additional Settings → Eye Comfort Mode

The colour temperature will be adjusted to reduce eye fatigue.

On: The colour temperature of your TV screen is adjusted.

Off: Turns off the Eye Comfort Mode.

Some models may not be supported.

HDMI ULTRA HD Deep Colour

HDMI ULTRA HD Deep Colour

Settings → All Settings icon → Picture → Additional Settings → HDMI ULTRA HD Deep Colour

If you connect a device that supports HDMI ULTRA HD Deep Colour, you can enjoy a clearer image.

After connecting the playback device, set HDMI ULTRA HD Deep Colour to On.

If the connected device does not support this function, it may not work properly.

In that case, change the TV's HDMI ULTRA HD Deep Colour setting to Off.

Supported Display Resolution

On : Supports 4K@60 Hz (4:4:4, 4:2:2 and 4:2:0)



Off : Supports 4K@60 Hz (4:2:0)

Instant Game Response

Using Instant Game Response

 →  → Picture → Additional Settings → Instant Game Response



Set the HDMI port connected to the device to be On to enjoy games with the optimal video for the game.

It works only when the  →  → Sound → Sound Out is Internal TV Speaker/Audio Out (Line Out)/Wired Headphones/Wired Headphones + Internal TV Speaker.

SETTINGS

Sound

Sound Mode Settings

 →  → Sound → Sound Mode Settings

Sound Mode

You can select the most suitable sound mode for each genre.

Standard : Optimises the sound for all types of content.

Cinema : Optimises the sound for cinemas.

Clear Voice III / Clear Voice IV : Boosts voice clarity.

Sports / Football / Cricket : Optimises the sound for sports games.

Music : Optimises the sound for music.

Game : Optimises the sound for gameplay.

Balance

You can adjust the volume of the left and right speakers.

ULTRA Surround

Enjoy an immersive soundscape with the virtual multi-programme surround sound effect.

This option can be enabled if Sound Mode is set to Standard.

Equalizer

You can set the desired sound by adjusting the equalizer directly.

(100 Hz/300 Hz/1 kHz/3 kHz/10 kHz)

This option can be enabled if Sound Mode is set to Standard.

Reset

You can reset the sound effect settings.



This option can be enabled if Sound Mode is set to Standard.

This setting is only available for Internal TV Speaker.

The configurable items differ depending on model

Sound Out

Setting Sound Out

 →  → Sound → Sound Out

When Instant Game Response is set to On, audio delays may occur if you set Sound Out to WiSA Speakers/Optical/HDMI ARC.

Switch to Internal TV Speaker or change  →  → Sound → Additional Settings → HDMI

Input Audio Format to PCM.

Internal TV Speaker

Audio is played through the TV's internal speakers.

Bluetooth

Wirelessly connect a Bluetooth audio device to enjoy TV sound more conveniently.

Refer to the user manual of the Bluetooth audio device for details on how to connect and use the device. Press DEVICE LIST to view the connected devices or the devices that can be connected to connect any one of them.

LG Sound Sync devices will automatically try to connect to the recently used devices when you turn the TV on.

We recommend that you connect an LG audio device that supports LG Sound Sync, using LG TV mode or LG Sound Sync mode on device.

If the device fails to connect, check the power of the device to connect to and check if the audio device is working properly.

Depending on the type of the Bluetooth device, the device may not connect correctly or an abnormal behavior may occur such as unsynchronized video and audio.

(The mobile-only headsets may not work.)

SETTINGS

Sound may stutter or sound quality may be reduced if:
the Bluetooth device is too far from the TV;
there are obstacles between the Bluetooth device and the TV; or
used together with radio equipment such as a microwave oven or wireless LAN.
If you continue to experience problems, we recommend using a wired connection. (Optical digital,
HDMI (ARC) port)

WiSA Speakers

WiSA Speakers is a speaker that uses the technology to transmit a multi 5.1 channel sound wirelessly.
You can wirelessly connect the TV to the WiSA Speakers to enjoy high-quality sound.

Select DEVICE LIST to adjust detailed settings for WiSA Speakers.

Some models may not be supported.

To use the WiSA speakers, you need to connect the exclusive dongle.

Connection issues between the WiSA Dongle and WiSA Speaker may occur in environments with
wireless interference. In this case, contact the speaker manufacturer.

For more information on the purchase of WiSA authorized products, check on www.wisaassociation.org.

Optical

You can connect an audio device that supports Optical to the optical digital audio output port to
enjoy your TV's sound in richer quality and greater convenience.

Only available for models with an optical digital port.

For some devices, you can adjust the volume using the TV remote control.

HDMI ARC

Sound from the TV can be output through an external audio device connected via a HDMI (ARC) port.

Select HDMI ARC to automatically turn on SIMPLINK. Once SIMPLINK is turned off, the output speaker
settings automatically revert to the default settings for uninterrupted audio output.

Audio Out (Line Out) / Wired Headphones

Select Wired Headphones or Audio Out (Line Out) to optimise audio output according to the device
connected.

Some models may not be supported.

If you connect the wired headphones while the TV is powered on, it automatically detects the wired
headphones and redirects audio through them.

Playing Audio through the TV's Internal Speakers and External Audio Device Simultaneously

Audio can be played through the multiple devices simultaneously.

Optical + Internal TV Speaker

Audio is played through the TV's built-in speakers and the audio device connected to the digital optical
audio output port simultaneously.

Wired Headphones + Internal TV Speaker

Audio is played through the TV's internal speakers and the Wired Headphones simultaneously.

Some models may not be supported.

If you connect the wired headphones while the TV is powered on, it automatically detects the wired
headphones and redirects audio through them.

TV Installation Type

 →  → Sound → Additional Settings → TV Installation Type

This mode optimises the sound based on the TV setup.

Stand

Select this if the TV is installed in stand-type.

Wall-mounted

Select this if the TV is installed in wall-mounted type.

This setting is only available for Internal TV Speaker

SETTINGS

Volume Mode

Setting Volume Mode

 →  → Sound → Additional Settings → Volume Mode

Auto Volume



Click On to adjust the volume automatically for different broadcasting companies so you can always listen to programmes at the desired volume, even after switching the programmes.

Volume Increase Amount

Select Low/Medium/High to adjust the volume range. Higher values increase increments.

This setting is only available for Internal TV Speaker.

DTV Audio Setting

 →  → Sound → Additional Settings → DTV Audio Setting

When different audio types exist in an input signal, this function allows you to select the audio type you want.

If set to Auto the search order is AC4 → HE-AAC → Dolby Digital Plus → Dolby Digital → MPEG and output is produced in the first Audio Format found.

The following search order may change depending on the country : AC4 → HE-AAC → Dolby Digital Plus → Dolby Digital → MPEG.

If the selected Audio Format is not supported, another Audio Format may be used for output.

Some models may not be supported.

AV Sync Adjustment

Adjusting AV Synchronization

 →  → Sound → Additional Settings → AV Sync Adjustment

Adjusts the synchronization of the sound from the speaker that is working.

The closer to Greater than, the slower the audio output.

Bypass, Outputs the broadcast signals or the sound from external devices without any audio delay.

The audio may be output before the video because of the time the TV takes to process the video input.

Available options vary by Sound Out setting.

HDMI Input Audio Format

 →  → Sound → Additional Settings → HDMI Input Audio Format

You can set the audio format for each HDMI input. When the voice delivered through the HDMI port is not synchronized, set it to PCM.

LG Sound Sync

 →  → Sound → Additional Settings → LG Sound Sync

Connect the LG Sound Sync device to the optical digital input port and set Sound Out to Optical.

By setting this feature to On, you can adjust the volume of the connected LG Sound Sync device using a TV remote control.

If the auto-power feature of the sound bar that supports LG Sound Sync is set to On, the sound bar will be turned on or off together when the TV is turned on or off.

Digital Sound Out

Setting Digital Sound Out

 →  → Sound → Additional Settings → Digital Sound Out

You can configure the Digital Sound Out settings.

This setting is only available when Settings All Settings icon Sound Sound Out is set to Optical/HDMI ARC.

When Pass Through is enabled, sound effects may not be output.

The codec output with a device may differ from input signals.

Dolby Atmos : Some models may not be supported.

SETTINGS

Programmes

Auto Tuning

Automatically Setting Up Programme

 →  → Programmes → Programme Tuning → Auto Tuning

Automatically tunes the programmes.

Select Country where the TV is used. Programme settings change depending on the country you choose.

Initiate Auto Tuning.

Select programme tuning modes.

Set Auto Tuning following screen instructions.

If Input Source is not connected properly, programme registration may not work.

Auto Tuning only finds programmes that are currently broadcasting.

If Safety is turned on, a pop-up window will appear asking for password.

Manual Tuning

To Use Manual Programme Tuning

 →  → Programmes → Programme Tuning (Programme Tuning & Settings) → Manual Tuning

This function is for manually searching and saving programmes.

For digital broadcasting, signal strength and signal quality can be checked.

Signal Test

To Use the Signal Test

 →  → Programmes → Programme Tuning (Programme Tuning & Settings) → Signal Test

Shows the MUX and Service information etc.

Signal test is only available in Antenna or Cable mode.

Some models may not be supported.

Programme Manager

Edit Programmes

You can edit the selected programmes from all the stored programmes or add/delete them to/from the favourite programmes.

Edit All Programmes List

 →  → Programmes → Programme Manager → Edit All Programmes

You can lock or unlock the selected programmes from all the stored programmes, or you can set them to be skipped when switching programmes.

1. Set the sorting option.

2. Lock/Unlock: Lock the selected programmes or unlock the locked programmes.

Skip / Restore : Set the selected programmes to be skipped when switching programmes, or disable the skipping option of the programmes previously set to be skipped.

Move : Move the selected programmes.

Edit Programme Numbers : Change the numbers of the selected programmes.

Delete : Delete the selected programmes.

Available features may vary depending on the broadcast signal.

For a model that supports satellite programmes, you can manage the satellite programmes in Edit Satellite Programmes (Advanced).

Edit Favourite Programmes List

 →  → Programmes → Programme Manager → Edit Favourites

You can add/delete desired programmes to/from the favourite programmes, change their positions, etc

1. Select the desired programmes from the all programmes list and press the button to add them to the favourite programmes list.

SETTINGS

2.Delete the selected programmes from the favourite programmes list.

3.Move : Select one or more programmes in the Preferred Programmes list, press the Move button, and then select the position to move it to. The selected programmes will move to the position you selected. Change Group Name : Change the name of the favourite programmes list. programmes list. Sort by Programme : Sorts the list of favourite programmes by programme.

Multi Feed

 →  → Programmes → Multi Feed

You can watch the desired angle on the TV through the broadcast that filmed from various angles. Some models may not be supported.

HbbTV

Learn More about HbbTV

HbbTV (Hybrid Broadcast Broadband TV) is a new broadcasting standard that enables super-teletext type services, delivered by a broadcast TV programme, to be integrated or linked to online services delivered over broadband to a connected Smart TV.

To see the details, click the Enjoy Live TV → HbbTV in User Guide.

Some models may not be supported.

What is CI Information

This function enables you to watch some encrypted services (pay services).

To see the details, click the Enjoy Live TV CI Information in User Guide.

Save CI Password

 →  → Programmes → Save CI Password

Input the Pin Code in Save CI Password. You don't need to input the Pin Code after save it.

You can see the Save CI Password when insert a CI CAM (Conditional Access Module) which is supported Pin Code.

If CI CAM has a Pin code, you can see the Reset CI Password.

Copy Programmes

 →  → Programmes → Copy Programmes

Export your TV's programme list information to a connected USB storage device or Import your Tv's programme list information from a connected USB storage device.

For Satellite models

Connection

TV Name

Setting the TV Name



 →  → Connection → TV Name

You can use the screen keyboard to set the name for the smart TV to be used on the network.

Up to 25 characters can be entered in case of English alphabet.

Network Connection Settings

Network Connection Settings

 →  → Connection → Network Connection Settings

If you configure settings for the network, you can use various services such as online contents and applications.

Setting a Wired Network

Select Wired Connection (Ethernet).

SETTINGS

If the router connected to the network supports the DHCP feature, connecting the TV and router by wire will automatically connects to the network. If the automatic setup is not supported, you can select Edit to manually set up the network connection.

Setting a Wireless Network

Select Wi-Fi Connection.

If you have set the TV up for a wireless network, you can check and connect to the available wireless Internet networks.

Add a hidden wireless network

If you input the name of network directly, you can add a wireless network.

Connect via WPS PBC.

If the wireless router you want to connect to has a Wi-Fi Protected Setup-Push Button Configuration (WPS-PBC) feature, you can easily connect to the wireless router by pressing the WPS-PBC button on the router. Press the wireless router's WPS-PBC button and then press the TV's [Connect] button.

Connect via WPS PIN.

This is a method to connect to an access point using a Wi-Fi Protected Setup-Personal Identification Number (WPS-PIN). Select the access point you want to connect to. Enter the PIN displayed on the access point's Wi-Fi device.

Advanced Wi-Fi Settings

Once you connect to a wireless network, you can view connection information such as detailed IP address information. In addition, you can change the IP address and DNS server address you want to connect to by pressing the Edit button.

The IPv6 setup does not support Edit.

For more information on how to connect to the network, see [Getting Started with webOS TV](#) → [Connecting to the Network in User Guide](#).

Mobile Connection Management

 →  → Connection → Mobile Connection Management

You can set to use a smart device connected to the TV to control the TV or manage the connection history.

TV On With Mobile

If Turn on via Wi-Fi or Turn on via Bluetooth is set to On, you can turn on your TV using an application that supports TV On With Mobile.

The TV should be connected to a network.

The TV and the device to be used should be connected to the same network.

The Turn on via Wi-Fi feature must be used in an app on a smart device that supports the feature.

The Turn on via Bluetooth feature can only be used with certain LG Electronics smartphones.

The TV must be plugged in.

To connect for the first time, make sure the device to be used is ready to connect.

Some models may not be supported.

Screen Share

You can delete the connection history of the device that was connected to the TV through Screen Share.

Sound Share



You can delete the connection history of the smart device that was connected to the TV via Bluetooth.

SETTINGS

General

Language

Configuring Language Settings

 →  → General → Language

You can choose the menu language displayed on the screen and the audio language of the digital broadcast.

Menu Language

You can select one of the menu languages to be displayed on the screen. The language for the speech recognition will be automatically set to the selected language for the menu.

The speech recognition is only applied to some models.

Primary Audio Language / Secondary Audio Language

You can choose the language you want when watching a digital broadcasting programme, which includes multiple audio languages.

For programmes that do not support multiple languages, the default will be used.

Applies to Digital broadcasting.

Keyboard Languages

Select the language to use the on-screen keyboard.

To Set Teletext Language

Sets Teletext language.

To see the details, click the Enjoy Live TV TELETEXT in User Guide.

In Digital Mode Only

Location

Setting the Location

 →  → General → Location

You can change the location setting of your Smart TV.

Address Setting

You can set the Region and City of your TV.

Broadcast Country

You can set the broadcast country on your TV.

Service Area Postcode

This function is used to set the broadcast location of the TV by entering your postcode.

Services Country

If you don't set the Set Automatically, you can select the country manually.

You must set the country manually when you are not connected to the network.

The configurable items differ depending on model.

SETTINGS

Time

 →  → General → Time

You can check the time or configure related settings.

Set Automatically

The TV time is automatically set to the time of digital broadcasting information sent from the broadcasting station or the time sent from the server.

Time / Date / Time Zone

You can manually set the time and date if the automatically set current time is incorrect.

If you set the time manually with the antenna connected, schedule information, programme guide, etc. may not function correctly.

Custom Time Zone

When select the Custom in Time Zone, Custom Time Zone menu is activated.

Timers

Sleep Timer

Sets the TV to turn off at a specified time.

If you do not want to use Sleep Timer, select Off.

Power On Timer

Set Power On Timer to On.

The TV is turned on and displays the set channel at the set time.

Time : Set the time at which to turn the TV on.

Timer Repeat : Set the day of the week. Set the option to None to operate the feature only once.

Input : Set an external input to display when the power is turned on.

Timer Programme : Set a channel to display when the power is turned on. This option can be set only when Input is set to TV.

Volume : Set audio volume to use when the power is turned on.

Power Off Timer

Set Power Off Timer to On.

The TV is turned off at the set time.

Time : Set the time at which to turn the TV off.

Timer Repeat : Set the day of the week. Set the option to None to operate the feature only once.

4 Hours Auto Power Off

If you do not press any button for 4 hours after the TV is turned on by a feature such as Power On Timer, the TV will be turned off automatically.

To ensure the TV does not automatically turn off, set 4 Hours Auto Power Off to Off.

Some models may not be supported.

To use Power On Timer/Power Off Timer, set the time correctly.

If Timer Repeat of Power On Timer/Power Off Timer is set to None

If the time set in the Power On Timer is passed while watching TV, the power will turn on automatically when it reaches the set time and the TV is turned off on the next day or later.

If the time set in the Power Off Timer is passed while TV is in standby, the power will turn off automatically when it reaches the set time while watching TV on the next day or later.

SETTINGS

TV Rating Locks



Enabling TV Rating Locks

This function operates according to information from the broadcasting station. Therefore if the signal has incorrect information, this function does not operate.

Prevents children from watching certain adult's TV programmes, according to the ratings limit set.

Enter a password to watch a blocked programme. Rating differs by country.

Press the Settings button on the remote control.

Select  →  → General → Safety.

Set Safety to On.

Select TV Rating Locks.

Supported only in the digital mode.

Some models may not be supported.

The initial password is set as "0000".

When France or Norway is selected for Country, the password is not "0000" but "1234".

Programme Locks

Enabling Programme Locks

Blocks the programmes that contain inappropriate contents for children. The programmes can be selected but the screen is blank and the audio is muted. To watch a locked programme, enter the password.

Press the  button on the remote control.

Select  → General → Safety.

Set Safety to On.

Select Programme Locks.

Select the Programmes to lock.

Select Lock / Unlock.

The initial password is set as "0000".

When France or Norway is selected for Country, the password is not "0000" but "1234".

Application Locks

Enabling Application Locks

You can lock or unlock the application.

Press the Settings button on the remote control.

Select All Settings icon → General → Safety.

Set Safety to On.

Select the Application Locks.

Select the Applications to lock.

The initial password is set as "0000".

When France or Norway is selected for Country, the password is not "0000" but "1234".

The lock function is not immediately available for the currently running application.

Reset Password

 →  → General → Safety → Reset Password

Set or change the password for the TV.

The initial password is set as "0000".

When France or Norway is selected for Country, the password is not "0000" but "1234".

SETTINGS

Resetting a Lost Password

If you lose the password you set, you can reset it as follows:

1. Press the Settings button on the remote control.
2. Select All Settings icon → General → Safety.
3. Press Programmes Up → Programmes Up → Programmes Down → Programmes Up on the remote control. The master password input window will appear.
4. Enter the numbers "0313" in the master password input window, then press Enter. The password will be reset.

Account Management



Managing Your LG Account

In Account Management, you can use your email address to create a new LG account.

For more information, see Getting Started with webOS TV → Account Management in User Guide.

Home Settings

Home Settings

 →  → General → Home Settings

Home Auto Launch

You can set Home to launch automatically when turning on the TV.

Home Promotion

You can turn on or off the advertisements on the Home screen.

The configurable items differ depending on model.

Settings Help



To Use Settings Help

Settings → All Settings icon → General → Additional Settings → Settings Help

If you select the setting menus, you will see the hints of the settings. Turn on/off description box in Settings.

Menu Transparency

Setting up Menu Transparency

 →  → General → Additional Settings → Menu Transparency

By setting this feature to On, you can make some of the menus (e.g. Live Menu, Search, etc.) transparent.

Screen Saver

Using the Screen Saver

 →  → General → Additional Settings → Screen Saver

When the currently displayed app has not received any user input for an hour, it will be replaced by a Screen Saver.

Setting the Screen Saver feature to Off, maintains the same display for an extended period, which may compromise quality. The compromised screen may not be recoverable.

No Signal Image

Configuring the Screen When There Is No Signal

 →  → General → Additional Settings → No Signal Image

You can turn on or off the image displayed when there is no signal.

On: The default image is displayed if there is no signal.

Off: The No Signal message is displayed if there is no signal.

SETTINGS

Eco Mode

Using ECO Mode

 →  → General → Additional Settings → Eco Mode

Set power options to reduce energy consumption.

Auto Power Off

Set the TV to turn off automatically when there has been no user input for a specified amount of time.

HDD Eco Mode

If you set the mode to On, the USB HDD connected to the TV will go into power-saving mode when it has been left unattended for an extended period of time.

The configurable items differ depending on model

Quick Start+

TV Power Setting

 →  → General → Additional Settings → Quick Start+

This setting puts your TV in standby mode when it's turned off so it will start up more quickly the next time it's turned on.

Set Quick Start+ to On.

Some models may not be supported.

Turning this option on may increase energy consumption.

Standby Light

To Set Power Indicator

 →  → General → Additional Settings → Standby Light

You can turn the standby light on or off.

Some models may not be supported.

Advertisement

 →  → General → Additional Settings → Advertisement

If your TV is connected to the Internet, webOS may use a frequency capping cookie to keep track of the number of times an ad is shown on your TV.

This information is used to help limit the number of times the same ad is displayed. You can clear this cookie or turn it on or off at any time by going to the Advertisement setting on your TV.

No personally identifiable information is tied to this cookie.

Some models may not be supported.

Accessibility

To Use Audio Guidance

 →  → Accessibility → Audio Guidance

If Audio Guidance is set to On, audio guides will be provided in various situations, such as when you change programmes, adjust the volume or change settings and input signals.

Audio Description

Menu for the Visually Impaired

 →  → Accessibility → Audio Description

The contents on the screen will be described with voice for visually impaired viewers.

You can use this function if the broadcasting company supports Audio Description for the visually impaired.

Some models may not be supported.

SETTINGS

Audio Type

 →  → Accessibility → Audio Type

Audio commentary or subtitles are provided for those who are hard of hearing or visually impaired.

Normal

Selects default Audio.

Audio Description

For the visually impaired Selects the preferred default Audio combined with Visual Impaired Audio.

Spoken Subtitle

For the visually impaired, selects the preferred Visual Impaired Audio only.

Any Supplementary Audio

Displays all supplementary audio.

Some models may not be supported.

Additional Audio Function

 →  → Accessibility → Additional Audio Selection

Audio commentary or subtitles are provided for those who are hard of hearing or visually impaired.

None

Selects default Audio.

Audio Description

For the visually impaired Selects the preferred default Audio combined with Visual Impaired Audio.

Clean Audio

For the hearing-impaired Selects the preferred Clean Effect and Hearing Impaired Audio.

Spoken Subtitle

For the visually impaired, selects the preferred Visual Impaired Audio only.

Some models may not be supported

High Contrast

Changing the Menu to High-Contrast Screen

 →  → Accessibility High Contrast

When this feature is set to On, it adjusts the background of some of the menus on the screen and font colours to highlight the contrast between the light and dark areas.

Grayscale

 →  → Accessibility → Grayscale

Change the colour of the menu on the screen to black and white tone to make its ambiguity very clear.

Set to On.

Invert Colours

 →  → Accessibility → Invert Colours

To enhance the visibility of the menus on the screen, you can invert and calibrate certain colours in some menus. Set to On

Hard of Hearing

To Set Hard of Hearing

Press the  button on the remote control.

Select  Accessibility.

Set Subtitles to On.

Set Hard of Hearing to On.

A caption will be provided for the hearing-impaired.

When the Hard of Hearing is turned On, it will be prioritized over the general captions.

Some models may not be supported.

SETTINGS

Subtitles

To Set Subtitle

 →  → Accessibility Subtitles

View subtitles when the TV station provides subtitled programming.

Change Subtitles to On and select subtitle setting. Some models may not be supported.

Applies to Digital broadcasting.

Support

Software Update

 →  → Support Software Update

Uses software update to check and obtain the latest version.

Allow Automatic Updates

If set to On, updates will be proceeded automatically without asking when there is a new update after a version check.

Check for updates

When checking for the latest update version, you can only perform updates if an update file of a later version is available. The TV automatically checks your software version but, if necessary, you can perform a manual check.

TV Information

 →  → Support → TV Information

You can view information including Model, Serial Number, Device Name.

Notifications

Using Notifications

 →  → Support Notifications

You can view all notifications from TV apps and service at the same time. You can view and delete each notification message. For notifications that support shortcuts, you can go directly to that app or website.

Additional Settings

 →  → Support Additional Settings

User Agreements

These are the terms and conditions for privacy for the use of Smart TV-related services.

Legal Notice



It's a legal notice for services provided via TV.

Open Source Software Notice

You can view the instructions for each item.

Reset to Initial Settings

Restoring the Default Settings

 →  → Support → Reset to Initial Settings

Return TV to its initial settings. This will revert all settings to their default values.

After reset, the TV will automatically turn off and on.

If Safety is set to On, you should type the password to Reset to Initial Settings.

Do not turn off the power during initialization.

We recommend that you reset the TV to Reset to Initial Settings before you sell it or transfer it to a third party.

11. Technical Specification

Product Model	75WOS630E	
Screen Size	75" diagonal	
Aspect Ratio	16:9	
Power Supply	AC 176-240V~,50/60Hz	
Power Consumption	320W	
TV System	PAL B/GD/K I,SECAM B/G D/K DVB-T/T2/C/S/S2(s/s2 option) (There is no DVB-C signal in some Countries or Areas.)	
Audio Output Power (Internal)	8Wx2	
Input Terminal	Antenna Input	x 2 (S2 option)
	USB Input	x 2
	HDMI Input	x 3
	VGA Input	NO
	PC AUDIO Input	NO
	Audio Input (L/R)	x 1
	Video Input	x 1
	YPbPr Input	NO
	RJ45 Input	x 1
	CI card In	x 1
	SCART In/Output	NO
	DC In (12V)	NO
Output Terminal	Earphone	x 1
	Audio Line Out(L/R)	NO
	Video Output	NO
	Optical	x 1
	Coaxial out	NO
Working Temperature	0°C~40°C	
Working Humidity	20% ~ 80% Non-condensing	

Note:the specification shown above may change without notice for quality improvement.

12. Supported Signal Modes

A.HDMI Mode

Resolution	Horizontal Frequency (Khz)	Vertical Frequency (Hz)
480p	31.468	59.94
576p	31.25	50.00
720p	45.00	60.00
1080i	33.75	60.00
1080p(1920x1080)	67.50	60.00
2160p(3840x2160)	67.50	30.00
2160p(3840x2160)	135.00	60.00

-When the signal received by the Display exceeds the allowed range, a warning message will appear on the screen.

-You can confirm the input signal format onscreen.

13. Simple Troubleshooting

If the display fails or the performance changes dramatically, check the display in accordance with the following instructions. Remember to check the peripherals to pinpoint the source of the failure.

Symptom	Solution
Power cannot be turned on. (Power indicator does not light.)	-Check that both ends of the power cable are plugged into the socket appropriately and the wall socket is operational
No Input Signal message appears.	-Check that the signal line is connected properly. -Check that the power of the relevant peripherals is turned on. -Check that the Input option that has been selected matches with the input signal.
The remote control does not function properly.	-Check the batteries are not drained. (Use new batteries.) -Check that the remote control is within the operating range. -Check that the remote control is pointed to the remote control window on the display. -Check that there are no obstacles between the remote control and the remote control window.
Flashing spots or stripes appear on the screen.	-Check that there are no emission (Car, HV cable or Neon lamp) or other possible interference sources.
Image colour or quality deteriorates.	-Check that all the video settings are adjusted appropriately, such as brightness, contrast, colour etc. -For more information about video settings, refer to OSD Functions in Chapter 2.
Screen position and size are incorrect.	-Check that the screen position and size is adjusted appropriately.
Image or colour is incorrect.	-Check that the signal line is connected properly. -When connecting to a PC, you can change the resolution of the PC to acquire the correct image. The discrepancy of the PC output signal may affect the display of the image.
Display warning message.	-Check that the input signal line is properly fixed. -Select the correct input signal. -For more information, refer to Supported Signal Modes in Chapter 4.



Nadamo se da ste pažljivo pročitali uputstva i da ćete ih se pridržavati.
Za više informacija o FOX uređajima posetite našu internet stranicu:

www.foxelectronics.rs