



UPUTSTVO ZA UPOTREBU

LED TELEVIZORI

Model: 42WOS640E

Hvala Vam što ste kupili ovaj uređaj.

FOX LED televizori prepoznaju se po odličnim tehničkim karakteristikama, kao i modernom, funkcionalnom i elegantnom dizajnu. Osim toga konstantna unapređenja u vidu postprodajne

podrške, izuzetno efikasna i rasprostranjena servisna mreža čine da se ponosni vlasnici **FOX televizora** mogu osećati sigurno.

Napravili ste pravi izbor.

U nastavku slede uputstva za upotrebu. Nisu komplikovana, ali ih se morate pridržavati.

SR

Informacije o proizvodu



Delegirana uredba EU komisije 2019/2013

Informacije		Vrednost	đ
1. Ime ili zaštitni znak isporučioaca:		FOX	
Naziv i adresa isporučioaca.:		Vimport doo, Batajnički drum 23, Beograd	
2. Identifikaciona oznaka modela:		42WOS640E	
3. Klasa energetske efikasnosti za Standardni dinamički opseg (SDR)		F	
4. Snaga u uključenom stanju za Standardni dinamički opseg (SDR)		42.0	W
5. Klasa energetske efikasnosti za Veliki dinamički opseg (HDR)			
6. Snaga u uključenom stanju za Visok dinamički opseg (HDR)			
7. Snaga u isključenom stanju		0.0	W
8. Snaga u stanju pripravnosti		0.5	W
9. Snaga u umrežanom stanju pripravnosti		2.0	W
10. Kategorija elektronskog ekrana		Televizor	
11. Odnos veličina		16 : 9	
12. Rezolucija ekrana (u pikselima)		1920 x 1080	piksela
13. Dijagonala ekrana		41.5	inča
14. Dijagonala ekrana		105.0	cm
15. Vidljiva površina ekrana		46.9	dm ²
16. Korišćena tehnologija panela		LCD sa LED	
17. Dostupna Automatska regulacija sjajnosti (ABC)		Ne	
18. Dostupan senzor za prepoznavanje glasa		Ne	
19. Dostupan senzor prisutnosti u prostoriji		Ne	
20. Frekvencija osvežavanja slike		60	Hz
21. Minimalna garantovana raspoloživost ažuriranja softvera i integrisanog softvera uređaja od datuma stavljanja na tržište (do):		3	(u godinama)
22. Minimalna garantovana raspoloživost rezervnih delova (do):		3	(u godinama)
23. Minimalno trajanje opšte garancije koju daje isporučilac (do):		3	(u godinama)
24. Tip napajanja:		Unutrašnje	
25. Spoljašnje napajanje (ako je priloženo uz proizvod, nije standardizovano)	Standardno ime		
	Ulazni napon		V
	Izlazni napon		V
26. Spoljašnje standardizovano napajanje (ako nije priloženo uz proizvod, drugo odgovarajuće napajanje)	Standardno ime		
	Potreban izlazni napon		V
	Potrebna minimalna jačina struje		A
	Potrebna frekvencija struje		Hz

VAŽNA BEZBEDONOSNA UPUTSTVA

UPOZORENJE

KAKO BISTE SPREČILI POŽAR ILI ELEKTRIČNI UDAR NEMOJTE KORISTITI PRODUŽNI KABL, DUPLI UTIKAČ ILI DRUGE DODATKE NA UTIČNICI OSIM ONIH KOJI BI MOGLI DA SPREČE IZAZIVANJE STRUJNOG UDARA. KAKO BISTE SPREČILI POŽAR ILI ELEKTRIČNI UDAR NE IZLAŽITE OVAJ UREĐAJ VLAZI ILI KIŠI.

 <p>Ovaj simbol munje u jednakostraničnom trouglu upozorava korisnike na prisustvo opasnog i ne izolovanog napona unutar kućišta proizvoda koji može biti dovoljan da stvori rizik STRUJNOG UDARA</p>	<p>CAUTION</p> <p>RISK OF ELECTRIC SHOCK DO NOT OPEN</p> <p>Upozorenje: Da biste smanjili rizik od strujnog udara nemojte skidati poklopac (ili zadnju stranu). Unutra nema delova koje korisnik može sam da zameni. Za obavljanje servisa zatražite pomoć kvalifikovanog osoblja.</p>	 <p>Znak uzvika unutar jednakostraničnog trougla u ovom uputstvu upozorava korisnika na prisustvo važnih instrukcija za rad i održavanje (servisiranje) uređaja.</p>
--	---	---

Ovaj aparat ne treba izlagati vodi, a predmete ispunjene tečnošću poput vaza ne treba da budu postavljeni na i oko uređaja.

OPREZ

Postoji opasnost od eksplozije ako se baterija nepropisno zameni.

Zamenite postojeću sa samo odgovarajućom vrstom baterije.

Nemojte izlagati bateriju direktnoj sunčevoj svetlosti ili bilo kojem drugom izvoru toplote.

Obezbedite pravilno odlaganje istrošenih baterija.

Ostavite lako dostupnim mesto gde je utikač ili nastavak za prekid napajanja.

Da biste smanjili rizik od strujnog udara, ne obavljajte bilo kakvo servisiranje osim onih koje se pominju u ovom uputstvu.

VAŽNE INFORMACIJE

Ako televizor nije postavljen na dovoljno stabilnom mestu, može postojati potencijalna opasnost od pada.

Mnoge povrede, posebno dečije, mogu se izbeći primenom jednostavnih mera opreza kao što su:

Korišćenje elemenata ili stalaka koje je preporučio proizvođač televizora.

Korišćenje samo onog nameštaja koji može sigurno izdržati uređaj.

Obezbeđivanje uređaja tako da ne prelazi ivicu nameštaja.

Nemojte postavljati TV na visok nameštaj (na primer, ormare ili police) bez prethodnog pričvršćivanja kako nameštaja tako i uređaja na odgovarajuću površinu.

Ne pokrivajte televizor krpom i ne stavljajte drugi materijal između televizora i nameštaja gde je uređaj postavljen.



Sigurna instalacija

Koristite pojas za fiksiranje televizora kako bi sprečili uređaj od pada napred.



1. **Pročitajte uputstva**- Sve napomene o sigurnosti i načinu rada treba pročitati pre uključivanja aparata.
2. **Sačuvajte uputstva** – Uputstva za sigurnost i uputstvo za upotrebu treba da se sačuvaju za buduće potrebe.
3. **Imajte u vidu Upozorenja** – Treba se pridržavati svih upozorenja na aparatu i svih uputstava za upotrebu.
4. **Pratite uputstva**- Treba pratiti sva uputstva.



5. **Voda i vlažnost** – Aparat ne treba koristiti u blizini vode.
6. **Nosač i postolje** – Aparat treba koristiti samo sa nosačem ili postoljem koje preporučuje proizvođač
7. **Montaža na zid ili plafon** – Aparat treba da se montira na zid ili plafon samo po preporuci proizvođača.
8. **Ventilacija** – Aparat treba da bude dobro postavljen, tako da lokacija ili pozicija aparata ne ometaju njegovo provetranje.
9. **Toplota** – Ovaj aparat treba postaviti dalje od izvora toplote kao što su radijatori i peći.
10. **Napajanje** - Aparat treba povezati samo na napajanje kao što je opisano u uputstvima za upotrebu ili onako kako je naznačeno na uređaju.
11. Treba preduzeti mere predostrožnosti.
12. **Zaštita kabla za napajanje** – Naponski kabl treba da bude usmeren tako da je malo verovatno da se može gaziti, priklještitu stvarima na njemu i njegovom kraju.
13. **Čišćenje** – Aparat bi trebalo čistiti samo po preporuci proizvođača.
14. Napajanje spoljne antene treba da se nalazi daleko od dalekovoda.
15. **Uzemljenje spoljne antene** – Ako je spoljna antena povezana na prijemnik, antenski sistem mora biti uzemljen kako bi se obezbedila zaštita od naponskog udara i statičkog elektriciteta.
16. **Kada ga dugo ne koristite** – napajanje uređaja trebalo bi da bude isključeno iz utičnice kada se ne koristi duži vremenski period.
17. **Upad predmeta i tečnosti** – Treba paziti da predmeti ne upadnu, a tečnost ne prospe u kućište kroz otvore.
18. **Kada je potreban servis** – Aparat treba da servisira kvalifikovano servisno osoblje kada su:
 - Kabal za struju ili utikač oštećeni.
 - Kada predmeti upadnu ili kada se tečnost prolje po uređaju
 - Kada je aparat izložen kiši
 - Kada aparat ne radi normalno ili pokazuje značajnu promenu u radu.
19. Ventilacioni otvori ne bi trebalo da budu pokriveni predmetima, kao što su novine, tkanine, zavese itd.
20. Izvore otvorenog plamena, kao što su upaljene sveće, ne bi trebalo da stoje na aparatu
21. Aparat će biti povezan sa mrežnom utičnicom sa zaštitnim uzemljenjem. Utičnica ili nastavak za prekid napajanja trebaju da budu lako dostupni.

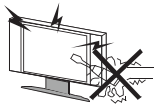

UPOZORENJE

Visok napon se koristi u napajanju ovog uređaja. Ne uklanjajte zadnji poklopac. Obratite se kvalifikovanoj osobi za obavljanje servisa.

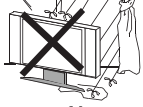

UPOZORENJE

Da biste sprečili požar ili strujni udar, nemojte izlagati uređaj kiši ili vlazi.



UPOZORENJE

Nemojte ispuštati i gurati predmete u kućište TV-a ili u otvore. Nikada nemojte prosipati tečnost na TV prijemnik.

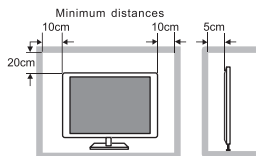

OPREZ

Ako televizor treba da se ugradi u zatvoreni odeljak ili na sličan način, morate se pridržavati dela uputstva o minimalnim udaljenostima. Toplota može smanjiti životni vek televizora, a takođe može biti povećan rizik od požara.



OPREZ

Nikada nemojte da stanete ili se oslonite ili gurnete uređaj ili stalak na kom se uređaj nalazi. Treba obratiti posebnu pažnju na decu.

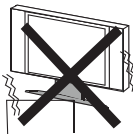

OPREZ

Ne stavljajte uređaj na nestabilno postolje, policu ili sto. Usled pada može doći do ozbiljne povrede lica ili štete na televizoru.

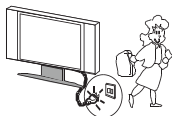

OPREZ

Kada se proizvod ne koristi duži vremenski period, preporučljivo je da isključite mrežni kabl iz utičnice .

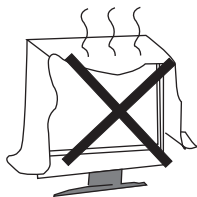

OPREZ

Izbegavajte izlaganje uređaja direktnom suncu i drugim izvorima toplote. Ne postavljajte televizor na druge proizvode koji emituju toplotu, na primer: Video uređaj, audio pojačala. Ne blokiraj otvore za ventilaciju u zadnjem poklopcu. Ventilacija je od suštinskog značaja za sprečavanje električnih kvarova. Ne stavljajte kabl za napajanje ispod televizora.



OPREZ

Panel (ekran) koji se koristi u ovom proizvodu napravljen je od stakla. Može se slomiti padom uređaja ili udarcem. Treba oprezno raditi sa razbijenim staklom ekrana.



- Postavite TV na stabilnu, ravnu površinu, ostavljajući najmanje 10 cm oko njega i 30 cm između vrha seta i zida ili ormarića. Da biste sprečili da se televizor prevrne kada ga gurnete, postavite ga blizu zida.

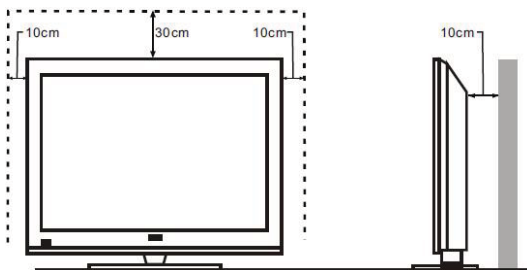

- Umesto da držite gornju stranu televizora kada ga okrećete, trebalo bi da držite donju stranu.

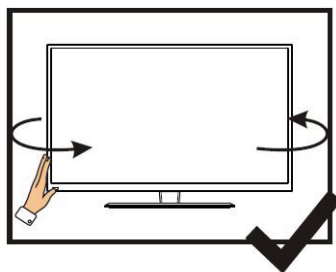
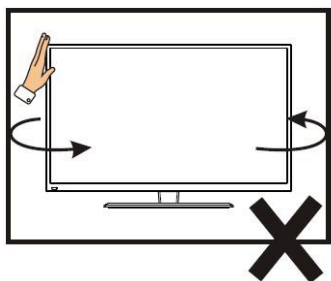

- Izbegavajte rukovanje televizorom samo jednom rukom kada ga podižete; umesto toga, koristite dve ruke.

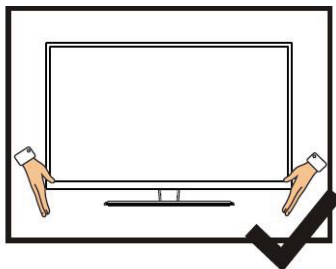
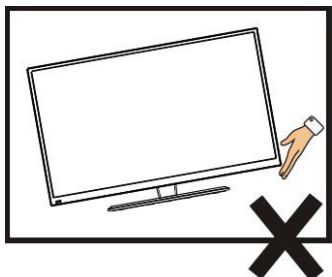

SADRŽAJ

1. Povezivanje i početno uključivanje TV-a	2
1.1 Pribor	2
1.2 Postavljanje postolja	2
1.3 Tasteri i interfejsi	3
1.4 Tasteri i interfejsi	4
1.5 Postavljanje baterija	5
2. Osnovni rad	5
2.1 UKLJUČIVANJE/ ISKLJUČIVANJE napajanja (opcionalno)	5
2.2 Postavljanje pripravnosti	5
3. Početna stranica	6
4. Podešavanja TV-a	7
5. Mediji	15
6. Tehničke specifikacije	17
7. Podržani režimi signala	18
8. Jednostavna rešenja problema	19

FOX LED TV

č č

1.1 Dodatna oprema

- ✧ Uputstvo za korišćenje
- ✧ Daljinsko upravljanje
- ✧ Baterija (UM-4/R03P/AA)
- ✧ Komplet za montiranje na zid (unapred montiran) (opciono)

1.2 Instalacija postolja

(Molimo pogledajte stvarni objekat za detalje o fizičkoj strukturi.)

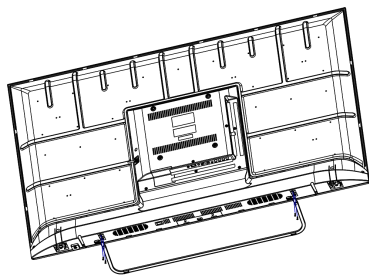

- 1) Postavite TV na mekanu tkaninu ili meke jastuke na sto tako da staklo bude okrenuta nadole.
- 2) Stavite postolja u donje utičnice televizora.
- 3) Zašrafite postolja sa zavrtnjima, a zatim ih zategnite.

FOX LED TV

1.3 Tasteri i interfejsi

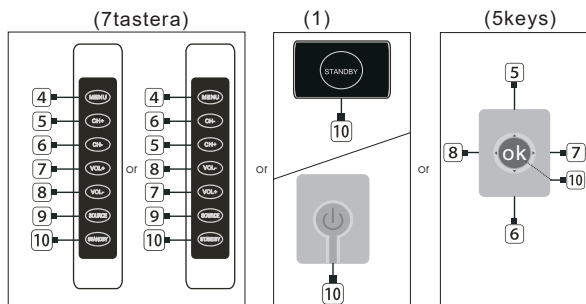
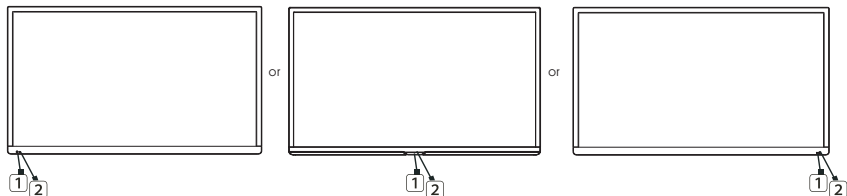

- 1 PROZOR DALJINSKOG SENZORA
- 2 INDIKATOR SNAGE
- 3 GOVNIK
- 4 MENU DUGME
- 5 PROGRAM "+" DUGME
- 6 PROGRAM "+" DUGME
- 7 VOLUME "+" DUGME
- 8 VOLUME "-" DUGME
- 9 SOURCE DUGME
- 10 TASTER PRIPRAVNOSTI
- 11 ULAZ ZA NAPAJANJE

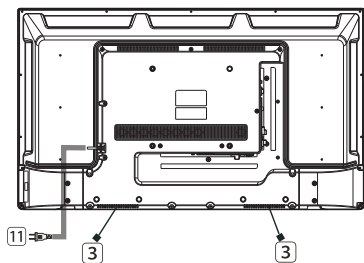

HDMI3	HDMI2 (ARC)	HDMI1	USB2 USB1 5V==500mA	EARPHONE
RJ45	OPTICAL	VIDEO	AV IN L R	RF IN (S2) 13V/18V==500mA
				RF IN (T2)

FOX LED TV

1.4 Dajinski upravljač



Molim Vas, gde je označeno #, taster pritisni duže (duže od jedne sekunde)

POWER: UKLJUČENO/ISKLJUČENO.

(STB POWER) Možete da uključite/isključite snagu set-top box dekodera.
0-9: Brojni tasteri - izbor željenog programa.

0#: Pojavio se ekran za brzo uređivanje programi **BRZI PRISTUP.**

LIST: Provera sačuvanih programi.

... : On prikazuje dodatne tastere na daljinskom upravljaču.

...# : Audibly opisuje sadržaj ekrana.

: Podešava nivo jačine zvuka.

: Potvrdite izbor za nestanak zvuka sa TV-a.

: Unesite meni pristupačnosti.

: Program možete promeniti.
Ispitajte predloženi sadržaj. (U zavisnosti od zemlje, usluge preporuke mogu, ali i ne mora biti ponuđene.)

: Da biste koristili funkciju prepoznavanja govora, pritisnite i držite taster dok govorite.

: Prikazuje meni početni ekran.

: Prikazuje listu koja je prethodno korišćena.

: Unosi meni "Brzo podešavanje".

: Unosi meni "Sva podešavanja".

Wheel (OK) : Da biste izabrali meni, pritisnite dugme Točak u centru.
Dugme na točkovima se koristi za promenu kanala.

(up/down/left/right) Pomerajte se po meniju pritiskom na dugme nagore, nadole, levo ili desno. Ako pritisnete dugme dok je pokazivač aktivan, kursor će nestati sa ekrana i Magični daljinski upravljač će se ponašati kao svaki drugi daljinski upravljač. Protresite magični daljinski upravljač levo i desno da ponovo prikažete pokazivač na ekranu.

: Premeštanje na prethodni korak

: Zatvara meni.

GUIDE Možete proveriti program.

NETFLIX idi na Netflix.

: Bira izvor unosa.

: Ulazimo u kućnu kontrolnu tablu.

prime video idite na udarni video.

Oni pristupaju posebnim funkcijama u nekim menijima.

MOVIES: Pretraži filmove.

: Igra.

: Pauziraj.

FOX LED TV

1.5 Instalacija baterija

(Molim vas da prevladate, ovo je samo skica.)

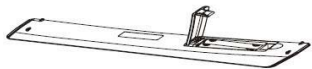

- 1 Zadnji poklopac daljinskog upravljača treba da bude otvoren.
- 2 Stavite dve 7# (AAA) 1.5V baterije u sistem.
Uverite se da su baterije pravilno polarizovane.
- 3 Pokrijte zadnji poklopac.

Izvadite baterije iz daljinskog upravljača ako ga neko vreme nije koristio.

Izvršite sledeće provere ako daljinski upravljač ne funkcioniše ispravno.

- Proverite da li je TV u programu.
- Proverite da li je polaritet baterija odgovarajući.
- Proverite da li baterije nisu iscrpljene.
- Uverite se da je napajanje u ispravnom stanju ili da je kabl za napajanje pravilno povezan.
- Uverite se da u blizini nema neobičnih neonskih ili fluorescentnih svetla.

2 Osnovna operacija

2.1 Uključivanje/isključivanje (opciono)

- Povežite kabl za napajanje sa **AC ulazni** . Utaknite kabl za napajanje u odgovarajuću utičnicu.
- Pritisnite **Prekidač** da uključite TV, zatim pritisnite **Napajanje** dugme za uključivanje jedinice.
- Pritisnite **Prekidač** ponovo da isključite TV.

Beleška: Nemojte odmah ponovo da otvarate prekidač za napajanje nakon što isključite TV; umesto toga, sačekajte jedan minut pre nego što ponovo otvorite prekidač za napajanje.

2.2 Podešavanje režima pripravnosti

- Pritisnite (⏻) dugme da biste uključili jedinicu.
- Pritisnite (⏻) dugme ponovo da vratite ekran u režim pripravnosti. Indikator napajanja svetli crveno.
- Uverite se da vaš TV nije ostavljen u režimu pripravnosti duži vremenski period.

2.3 Izbor režima unosa

Ovaj set sadrži više modova izvora signala; pritisnite dugme **Source** više puta da biste izabrali izvor signala.

FOX LED TV

2.3 Početna stranica

Uđite u početnu stranicu nakon postavljanja po prvi put.
U listi aplikacija odaberite aplikaciju u koju želite da uđete.

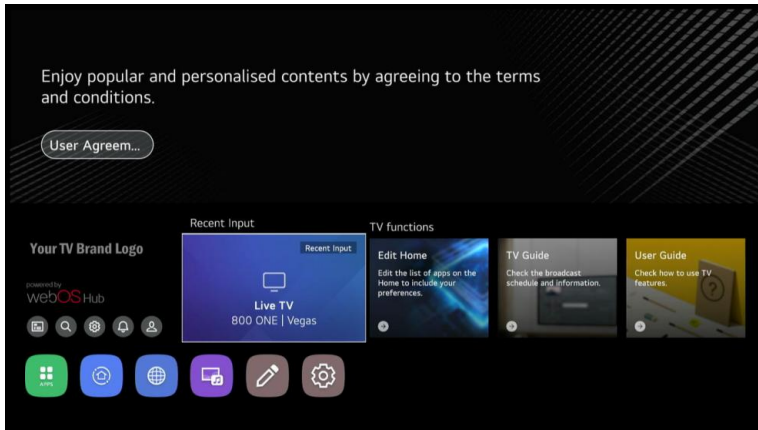

Upotreba kućnog čvorišta

Pritisnite taster **▼ / ▲ / ◀ / ▶** za izbor kućnog čvorišta ili pritisnite taster ULAZ za upotrebu kućnog čvorišta.

Možete da odaberete ili kontrolirate uređaj (mobilni, Bluetooth, vanjski uređaj itd.) povezane na TV. Pritisnite taster za izbor. **▼ / ▲ / ◀ / ▶**

TV/Ulaz

1. Možete da pokrenete zvuk iz pametnog uređaja povezanog putem Bluetooth-a. Molimo da pogledate Povezivanje vanjskih uređaja Pokretanje zvuka iz Pametnog uređaja putem zvučnika TV-a u Korisnički vodič za više informacija o radnji.
2. Možete da proverite i odaberete vanjski uređaj povezan putem vanjskog ulaza ili mreže.

Povežite mobilni uređaj

Možete da proverite i odaberete pametni uređaj povezan s aplikacijom LG ThinQ. Molimo da pogledate Povezivanje vanjskih uređaja Povezivanje pametnih uređaja u Korisnički vodič za više informacija o radnji.

FOX LED TV

4. Postavljanje TV-a

Pritisnite taster **MENI** da biste ušli u podešavanja TV-a

Pritisnite taster **▼ / ▲ / ◀ / ▶** za isticanje željene ikonice menija i pritisnite taster OK za izbor.

Brze

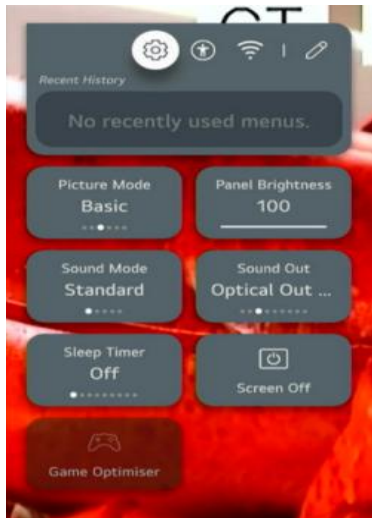

- ① Možete da postavite **Način slike**.
- ② Možete postaviti **Svetlina ploče**.
- ③ Možete da postavite **Način zvuka**.
- ④ Možete da odaberete **Izbacivanje zvuka**.
- ⑤ Možete da postavite **Merač vremena spavanja**.
- ⑥ Možete da postavite **Ekran isključen**.
- ⑦ Možete da postavite **Optimizator igre**.
- ⑧ Možete da dodate/ obrišete stavke brzih postavki ili promenite njihov redosled.

Sve

Pritisnite taster **▼ / ▲ / ◀ / ▶** za izbor Sve podešavan^{⚙️}

Pritisnite taster **<OK>** za ulazak u podmeni.

Pritisnite taster **▼ / ▲** za izbor Slika/Zvuk/Opšte/Podrška.

FOX LED TV

Slika

Pritisnite taster ▼ / ▲ za izbor Slika. Pritisnite taster **OK** za ulazak u podmeni i postavljanje.

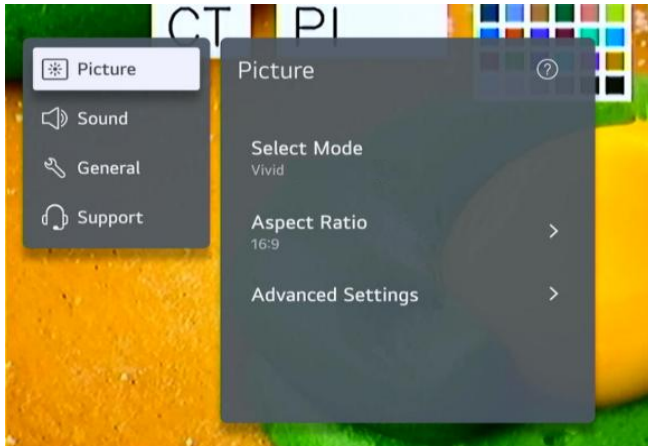

Odaberite način

Pritisnite taster ▼ / ▲ za izbor Odabrati način.

Pritisnite taster <OK> za ulazak u podmeni.

Pritisnite taster ▼ / ▲ za izbor Živopisno/Standardno/osnovno/Bioskop/Sport/Optimizator igre.

Format prikaza

Možete da promenite veličinu ekrana u skladu s vrstom sadržaja kojeg gledate. Pritisnite ▼ / ▲ izbor. Izbor korisnika/samo skenirati.

korisnika

Pritisnite taster ▼ / ▲ za izbor Format prikaza.

Samo skenirati

Pritisnite taster ▼ / ▲ za izbor Samo skenirati.

Ako **Uključite** ovu osobinu možete da pregledate sadržaj u Format prikaza koji se nalazi u signalu emitovanja ili izvoru sadržaja.

Napredn

Pritisnite taster ▼ / ▲ za izbor Napredne podešavanja.

Pritisnite taster <OK> za ulazak u podmeni.

Pritisnite taster ▼ / ▲ za izbor Svetlina/Boja/Jasnoća/Primeniti na sve ulaze/Resetovati.

FOX LED TV

Zvuk

Pritisnite taster ▼ / ▲ za izbor Zvuk. Pritisnite taster **OK** za ulazak u podmeni i postavljanje.

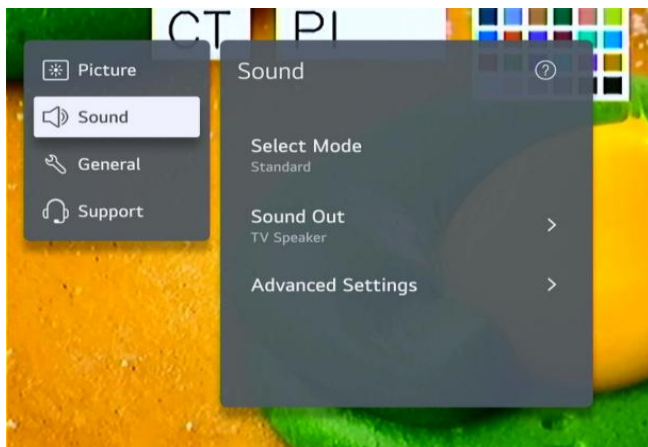

Odaberite način

Pritisnite taster ▼ / ▲ za izbor Odabrati način.

Pritisnite taster <OK> za ulazak u podmeni.

Pritisnite taster ▼ / ▲ za izbor.

Izbacivanje zvuka

Pritisnite taster ▼ / ▲ za izbor Izlaz zvuka.

Pritisnite taster <OK> za ulazak u podmeni.

Pritisnite taster ▼ / ▲ za izbor.

Napredne

Pritisnite taster ▼ / ▲ za izbor Napredne podešavanja.

Pritisnite taster <OK> za ulazak u podmeni.

Pritisnite taster ▼ / ▲ za izbor.

Balans

Izbalansirani levi i desni kanali.

Pritisnite taster **OK** za izbor Balans. Pritisnite taster ▼ / ▲ za podešavanje.

FOX LED TV

Ekvilajzer

Pritisnite taster ▼ / ▲ za izbor Ekvilajzer.

Pritisnite taster OK za ulazak u podmeni a zatim pritisnite taster ▼ / ▲ / ◀ / ▶ za podešavanje.

Primenite na svim ulazima

Pritisnite taster ▼ / ▲ za izbor Primeniti na sve ulaze.

Resetovanje

Možete da resetujete podešavanja efekta zvuka.

Pritisnite taster ▼ / ▲ za izbor Resetovati.

Vrsta postavljanja

Pritisnite taster ▼ / ▲ za izbor Vrsta postavljanja.

Pritisnite taster ▼ / ▲ za izbor Postolje/Montirano na zid.

Automatsko podešavanje jačine zvuka

Pritisnite taster ▼ / ▲ za izbor Automatska jačina. Pritisnite taster OK da odaberete On (uključeno)/Off (isključeno).

DTV Audio

Pritisnite taster ▼ / ▲ za izbor Zvučne podešavanja DTV-a.

Pritisnite taster ▼ / ▲ za izbor MPEG/ Dolby Digital/ Dolby Digital Plus/ HE-AAC/ Auto.

Podudarite ekran i zvuk

Pritisnite taster ▼ / ▲ za izbor sinhronizuj video i zvuk.

Odaberite HDMI Audio format ulaza

Pritisnite taster ▼ / ▲ za izbor Audio format ulaza HDMI.

Možete da postavite audio format za svaki HDMI ulaz. Kada glas koji se dostavlja putem HDMI utora nije sinhronizovan, postavite ga na **PCM**.

Digitalno izbacivanje zvuka

Pritisnite taster ▼ / ▲ za izbor Digitalni izlaz zvuka.

eARC podrška

Pritisnite taster ▼ / ▲ za izbor Podrška za eARC.

FOX LED TV

Opšte

Pritisnite taster ▼ / ▲ za izbor Opšte. Pritisnite taster **OK** za ulazak u podmeni i podešavanje.

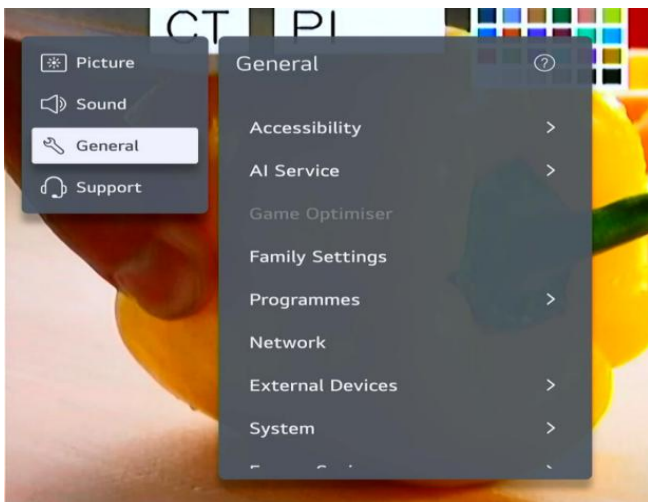

Pristupačnost

Pritisnite taster ▼ / ▲ za izbor Pristupačnost. Pritisnite taster **OK** za ulazak u podmeni.

Jačina za Audio Opis

Pritisnite taster ▼ / ▲ za izbor Jačina za audio opis. Pritisnite taster **OK** za izbor.

Više o daljinskom upravljaču

Pritisnite taster ▼ / ▲ za izbor Više o daljinskom upravljaču.

Uživajmo zajedno u zvuku TV-a

Pritisnite taster ▼ / ▲ za izbor Uživajmo zajedno u zvuku TV-a. Pritisnite taster ▼ / ▲ za izbor.

ć

Pritisnite taster ▼ / ▲ za izbor osoba sa oštećenim sluhom. Pritisnite taster **OK** da odaberete **On** (uključeno)/**Off** (isključeno).

Titlovanja

Pritisnite taster ▼ / ▲ za izbor Titlovi. Pritisnite taster ▼ / ▲ za izbor jezik prvog izbora titla i jezik drugog izbora titla i pritisnite taster **OK** za podešavanje jezika.

FOX LED TV

Visoki kontrast

Pritisnite taster ▼ / ▲ za izbor Visoki kontrast. Pritisnite taster OK da odaberete On (uključeno)/Off (isključeno).

Sivi tonovi

Pritisnite taster ▼ / ▲ za izbor Nijanse sive. Pritisnite taster OK da odaberete On (uključeno)/Off (isključeno).

Invert boje

Pritisnite taster ▼ / ▲ za izbor Invertujte boje. Pritisnite taster OK da odaberete On (uključeno)/Off (isključeno).

AI Usluga

Možete omogućiti preporučene usluge na osnovu istorije upotrebe.

Pritisnite taster ▼ / ▲ za izbor AI Usluga. Pritisnite taster OK za ulazak u podmeni.

Optimizator igre

Pritisnite taster ▼ / ▲ za izbor Optimizator igre.

č

Pritisnite taster ▼ / ▲ za izbor podešavnje ograničenja upotrebe.

Pritisnite taster ◀ / ▶ za izbor podešavnjaograničenja upotrebe/ Način brige za oči/ Način ograničenja jačine/ Izveštaj o vremenu ispred ekrana. Pritisnite taster OK za ulazak u podmeni. Pritisnite taster OK za omogućavanje ove funkcije.

Programi

Pritisnite taster ▼ / ▲ za izbor Programi. Pritisnite taster OK za ulazak u podmeni.

Mreža

Pritisnite taster ▼ / ▲ za izbor Mreža.

Vanjski uređaji

Pritisnite taster ▼ / ▲ za izbor uređaji. Pritisnite taster OK za ulazak u podmeni.

Sistem

Pritisnite taster ▼ / ▲ za izbor Sistem. Pritisnite taster OK za ulazak u podmeni i podešavanje.

Jezik

Možete da odaberete jezik menija prikazan na ekranu i audio jezik digitalnog emitovanja

Pritisnite taster ▼ / ▲ za izbor jezika. Pritisnite taster OK za ulazak u podmeni.

FOX LED TV

Možete da promenite podešavanje lokacije svog SMART TV-a.

Pritisnite taster ▼ / ▲ za izbor lokacija. Pritisnite taster OK za ulazak u podmeni.

Vreme i merač vremena

Možete da proverite vreme ili konfigurirate povezana podešavanja.

Pritisnite taster ▼ / ▲ za izbor Vreme. Pritisnite taster **OK** za ulazak u podmeni.

Bezbednost

Pritisnite taster ▼ / ▲ za izbor Bezbednost. Pritisnite taster OK za ulazak u podmeni.

Sve opcije su dostupne tek kada je uključena Bezbednost.

Početna lozinka je postavljena na "0000".

Pritisnite taster ▼ / ▲ za izbor opcije a zatim pritisnite taster OK za postavljanje.

Dodatne

Pritisnite taster ▼ / ▲ za izbor Dodatne podešavanja. Pritisnite taster OK za ulazak u podmeni.

Resetovati na početne

Pritisnite taster ▼ / ▲ za izbor Resetovanje na početne podešavanja Pritisnite taster OK za ulazak u podmeni.

Vratite TV na početne podešavanja. Ovo sva podešavanja vraća na fabrička podešavanja. Nakon resetovanja, TV će se automatski isključiti i uključiti.

Napomena: ako je bezbednost postavljena na Uključeno, trebali biste da unesete lozinku za vraćanje na početna podešavanja.

Ušteda energije

Smanjuje potrošnju energije podešavanjem svetline slike

Pritisnite taster ▼ / ▲ za izbor.

FOX LED TV

Podrška

Istaknite stavku i pritisnite taster OK za ulazak u podmeni.

Pritisnite taster ▼ / ▲ za izbor Podrška.

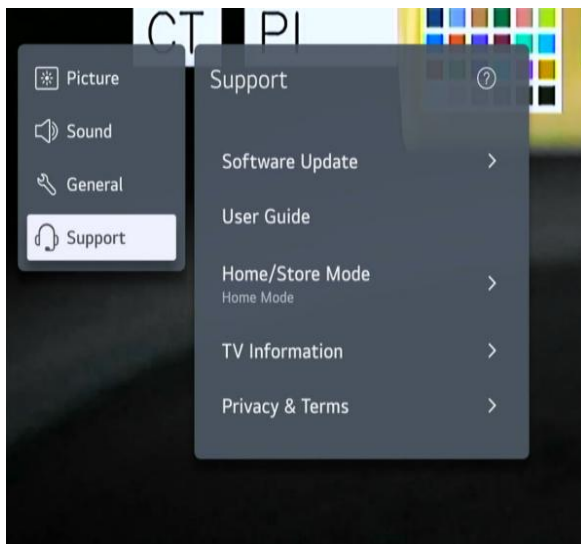

Ažur. softvera

Koristi ažuriranje softvera za proveru i dobijanje najnovije verzije.

Pritisnite taster zatim ▼ / ▲ za izbor Ažuriranje softvera. Pritisnite taster **OK** za ulazak u podmeni.

pritisnite taster ▼ / ▲ za izbor i podešavanje.

Korisnički vodič

Pritisnite taster ▼ / ▲ za izbor Korisnički vodič. Pritisnite taster **OK** za ulazak u podmeni.

Zatim pritisnite taster ▼ / ▲ za izbor i postavljanje.

č

ć

Pritisnite taster ▼ / ▲ za izbor Početna stranica/režim pamćenja. Pritisnite taster **OK** za ulazak u podmeni.

Zatim pritisnite taster ▼ / ▲ za izbor i podešavanje.

TV Informacije

Pritisnite taster ▼ / ▲ za izbor Informacije o TV-u.

Uslovi & privatnosti

Pritisnite taster Zatim ▼ / ▲ za izbor Privatnost i uslovi. Pritisnite taster **OK** za ulazak u podmeni.

pritisnite taster ▼ / ▲ za izbor i podešavanje.

FOX LED TV

5. Mediji

Povežite USB uređaj (USB HDD, USB stik) na USB ulaz na TV-u da biste pogledali datoteke sadržaja pohranjene na USB uređaju na vašem TV-u.

Pritisnite taster **▼ / ▲** za izbor Fotografija i video zapis/Fotografija/Video/Muzika.

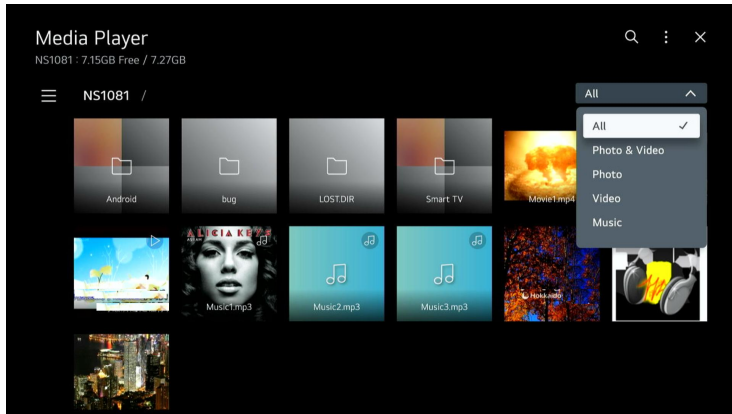

Fotografija

Odabirom Fotografija u aplikaciji Fotografije i video zapisi pokrećete reprodukciju fotografija. Možete pregledati svoje sačuvane fotografije.

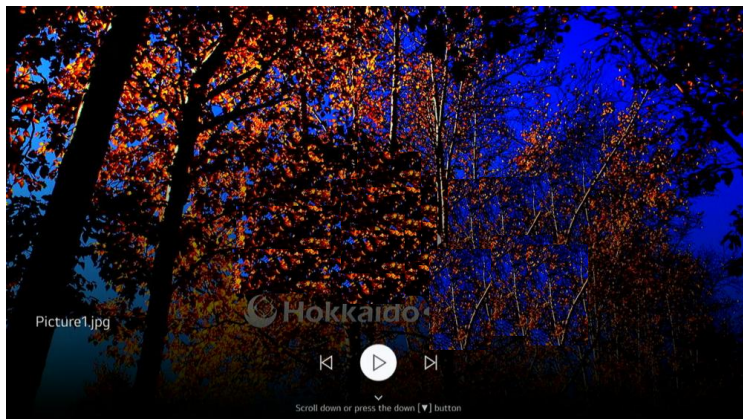

FOX LED TV

Video

Izborom Video zapis u aplikaciji Fotografije i video zapisi pokrećete reprodukciju video zapisa. Možete pregledati svoje sačuvane video zapise.

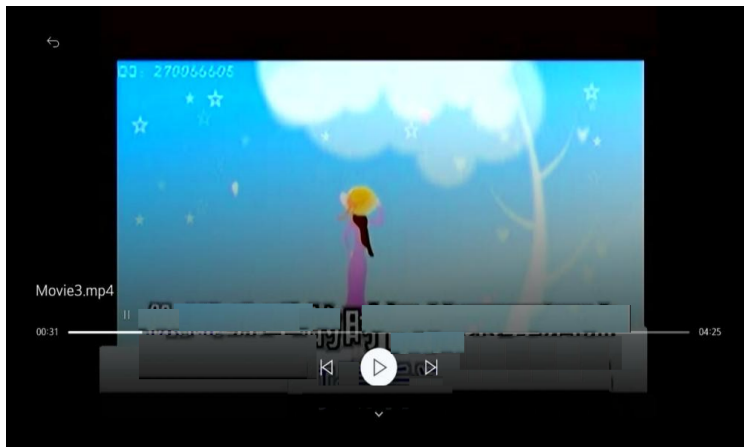

Muzika

Možete da pokrećete muziku izborom muzičkih datoteka sačuvanih u aplikaciji Muzika ili izborom ikonice za reprodukciju muzike tokom reprodukcije sadržaja u aplikacijama kao što su Fotografije i video zapisi.

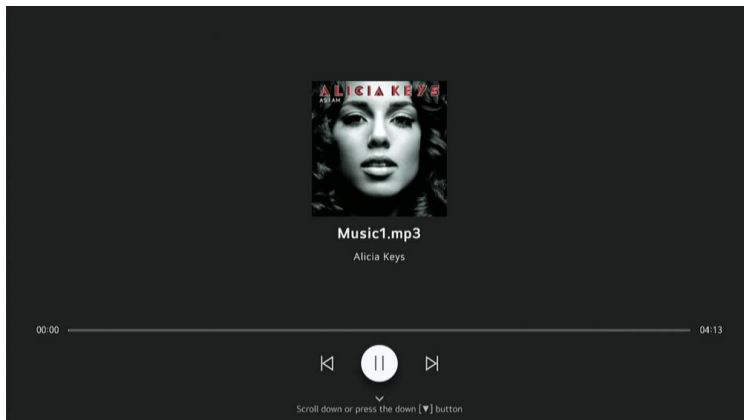

FOX LED TV

6. Tehnička specifikacija

Model proizvoda	32WOS640E	
Veličina ekrana	32" dijagonala	
Proporcija širine i visine	16:9	
Napajanje	AC 100-240V~,50/60Hz	
Potrošnja struje	60W	
TV sistem	PAL B/G D/K I,SECAM B/G D/K DVB-T/T2/C/S/S2 (opcija s/s2) (DVB-C signal je odsutan u nekim zemljama ili regionima.)	
Audio izlazna snaga (interna)	8Wx2	
Ulazni terminal	Antenski ulaz	x 2(S2 opcija)
	USB ulazni	x 2
	HDMI ulazni	x 3
	VGA ulazni	NE
	PC AUDIO ulazni	NE
	Audio ulazni (L/R)	x 1
	Video ulazni	x 1
	YPbPr ulazni	NE
	RJ45 ulazni	x 1
	Ulazni CI kartice	x 1
	SCART ulazni/izlazni	NE
	DC ulazni (12V)	NE
Izlazni terminal	Slušalica	x 1
	Audio linijski izlazni (L/R)	NE
	Video izlazni	NE
	Optički	x 1
Koaksijalni izlazni	NE	
Radna temperatura	0°C~40°C	
Radna vlažnost	20% ~ 80% Bez kondenzacije	

Beleška: Gore navedene karakteristike su podložne promeni bez upozorenja u cilju poboljšanja kvaliteta.



Manufactured under license from Dolby Laboratories. Dolby, Dolby Audio, and the double-D symbol are trademarks of Dolby Laboratories Licensing Corporation.

FOX LED TV

7. Podržani režimi signala

A HDMI režim

Rezolucija	Horizontalna frekvencija (Khz)	Vertikalna frekvencija (Hz)
480p	31.468	59.94
576p	31.25	50.00
720P	45.00	60.00
1080i	33.75	60.00
1080P(1920x1080)	67.50	60.00

- Poruka upozorenja će se pojaviti na ekranu ako je signal koji ekran prima izvan dozvoljenog opsega.

-Na ekranu možete proveriti format ulaznog signala.



The terms HDMI, HDMI High-Definition Multimedia Interface, HDMI trade dress and the HDMI Logos are trademarks or registered trademarks of HDMI Licensing Administrator, Inc.

FOX LED TV

8. Jednostavno otklanjanje poteškoća

Ako ekran pokvari ili se njegove performanse drastično promene, proverite ekran u skladu sa smernicama u nastavku. Ne zaboravite da pregledate periferne uređaje kako biste identifikovali koren problema.

Simptom	Rešenje
Napajanje se ne može aktivirati. (Indikator napajanja ne svetli.)	-Potvrdite da su oba kraja kabla za napajanje pravilno uključena u utičnicu i da li je zidna utičnica funkcionalna.
Prikazuje se poruka Nema ulaznog signala.	- Proverite da li je signalna linija ispravno povezana. -Potvrdite da su relevantni periferni uređaji uključeni. -Uverite se da izabrani izbor ulaza odgovara ulaznom signalu.
Daljinski upravljač ne radi ispravno.	-Proverite da baterije nisu istrošene. (Koristite novu bateriju.) -Potvrdite da daljinski upravljač radi u svom dometu. - Uverite se da je daljinski upravljač usmeren ka IR senzoru televizora. - Uverite se da nema prepreka između daljinskog upravljača i njegovog IR senzora.
Na ekranu se nalaze trepćuće tačke ili pruge.	- Uverite se da nema emisija (auto, VN žice ili neonske sijalice) ili drugih potencijalnih izvora smetnji, u blizini televizora.
Boja ili kvalitet slike se pogoršavaju.	- Proverite da li su sva video podešavanja, kao što su osvetljenost, kontrast i boja, pravilno podešena. -Za dodatne informacije o video postavkama, pogledajte OSD funkcije poglavlja 2.
Položaj i veličina ekrana su netačni.	-Potvrdite da su pozicija i veličina ekrana na odgovarajući način podešene.
Slika ili boja su netačne.	- Proverite da li je signalna linija ispravno povezana. -Kada ste povezani sa računarom, možete da promenite rezoluciju računara da biste dobili odgovarajuću sliku. Disparitet u izlaznom signalu računara može uticati na prikaz slike.
Prikažite poruku upozorenja.	- Proverite da li je ulazna linija signala na odgovarajući način obezbeđena. -Izaberite odgovarajući ulazni signal. -Pogledajte Podržani režimi signala u poglavlju 4 za dodatna podešavanja.



USER MANUAL

LED Television Model: 42WOS640E

Thank you for purchasing this device.

FOX LED televisions are known for their great performance, as for modern, functional and elegant design. Besides that, we constantly improve our customer support, we have highly efficient and wide network of services, that make our proud customers feel safe.

You made a right choice.

Now it's time for instructions, they are not complicated, but you have to follow them.

EN

IMPORTANT SAFETY INSTRUCTIONS

WARNING

- TO PREVENT FIRE OR SHOCK HAZARD, DO NOT USE AN EXTENSION CORD, RECEPTACLE OR OTHER OUTLET UNLESS THE BLADES CAN BE TO PREVENT BLADE EXPOSURE.
- TO PREVENT FIRE OR SHOCK HAZARD, DO NOT EXPOSE THIS APPLIANCE TO RAIN OR MOISTURE.



This lightning flash with arrowhead symbol in an equilateral triangle alerts users to the presence of uninsulated dangerous voltage within the products enclosure that may be of sufficient magnitude to constitute a risk of electric shock.

CAUTION

**RISK OF ELECTRIC SHOCK
DO NOT OPEN**

Warning: To reduce the risk of electric shock, do not remove cover (or back). No user serviceable parts inside. Refer servicing to qualified service personnel.



The exclamation mark within an equilateral triangle alerts users to the presence of important operating and maintenance (servicing) instructions in the literature accompanying the appliance.

This appliance should not be exposed to water and no object filled with liquid such as a vase should be placed on the unit.

CAUTION

- Danger of explosion if batteries are incorrectly replaced.
- Replace with only equivalent type of battery.
- Do not expose battery to direct sunlight or any other source of heat.
- Ensure proper disposal of used batteries.
- Where the MAINS plug or an appliance coupler is used as the disconnect device, the disconnect device shall remain readily operable.
- To reduce the risk of electric shock, do not perform any servicing other than what is mentioned in the operating manual.
- There are no user-serviceable parts inside the TV; do not open the TV casing.

IMPORTANT INFORMATION

If a television is not positioned in a sufficiently stable location, it can be potentially hazardous due to falling. Many injuries, particularly to children, can be avoided by taking simple precautions such as:

- Using cabinets or stands recommended by the manufacturer of the television.
- Only using furniture that can safely support the television.
- Ensuring the television is not overhanging the edge of the supporting furniture.
- Not placing the television on tall furniture (for example, cupboards or bookcases) without anchoring both the furniture and the television to a suitable support.
- Not standing the televisions on cloth or other materials placed between the television and supporting furniture.
- Educating children about the dangers of climbing on furniture to reach the television or its controls.



Safe installation

Use the belt fixing the television to facilitate restraining the television from toping forward.



1. **Read Instructions** - All the safety and operating instructions should be read before the appliance is operated.
2. **Retain Instructions** - The safety and operating instructions should be retained for future reference.
3. **Heed Warnings** - All warnings on the appliance and in the operating instructions should be adhered to.
4. **Follow Instructions** - All operating instructions should be followed.



5. **Water and Moisture** - The appliance should not be used near water.
6. **Cart and Stands** - The appliance should only be used with a cart or stand that is recommended by the manufacturer.
7. **Wall or Ceiling Mounting** - The appliance should be mounted to a wall or ceiling only as recommended by the manufacturer.
8. **Ventilation** - The appliance should be well situated so that its location or position does not interfere with its proper ventilation.
9. **Heat** - This appliance should be placed away from heat sources such as radiators, heat registers and stoves.
10. **Power Sources** - The appliance should only be connected to a power supply as described in the operating instructions or as marked on the appliance.
11. **Grounding or Polarization** - Precautions should be taken.
12. **Power Cord Protection** - Power supply cord should be routed so that it is not likely to be walked on, pinched by items placed upon it against the cord and its end.
13. **Cleaning** - The appliance should be cleaned only as recommended by the manufacturer.
14. **Power Line** - An outdoor antenna should be located away from power lines.
15. **Outdoor Antenna Grounding** - If an outside antenna is connected to the receiver, the antenna system must be grounded so as to provide against voltages and built-up static charges.
16. **Non-use Periods** - The power cord of the appliance should be unplugged from the outlet when left unused for a long period of time.
17. **Object and Liquid Entry** - Care should be taken so that objects did not fall, and liquids are not spilled into the enclosure through openings.
18. **Conditions requiring Service** - The appliance should be serviced by qualified service personnel when:
 - The power-supply cord or the plug has been damaged.
 - Objects have fallen on or liquid has been spilled into the appliance.
 - The appliance has been exposed to rain.
 - The appliance does not appear to operate normally or exhibits a marked change in performance.
19. The ventilation should not be impeded by covering the ventilation opening with items, such as newspapers, table-cloths, curtains, etc.
 No naked flame sources, such as lighted candles, should be placed on the apparatus.
 The apparatus shall be connected to mains socket outlet with a protective earthing connection.
 The appliance coupler regard as disconnection device, the disconnect device shall remain readily operable.

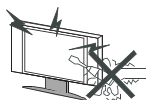

Warning

High voltages are used in the operating of this product. Do not remove the back cover of the cabinet. Refer servicing to qualified service personnel.

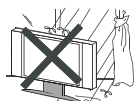

Warning

To prevent fire or electrical shock hazard, do not expose the main unit to rain or moisture.



Warning

Do not drop or push objects into television cabinet slots or openings. Never spill any kind of liquid on the television receiver.

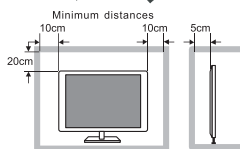

Caution

If the television is to be built into a compartment or similarly enclosed, the minimum distances must be maintained.

Heat built up can reduce the service life of your television, and can also be dangerous.



Caution

Never stand on, lean on, push suddenly the product or its stand.

You should pay special attention to children.

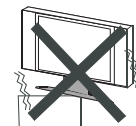

Caution

Do not place the main unit on an unstable cart stand, shelf or table.

Serious injury to an individual, and damage to the television, may result should it fall.

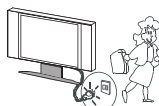

Caution

When the product is not used for an extended period of time, it is advisable to disconnect the AC power cord from the AC outlet.

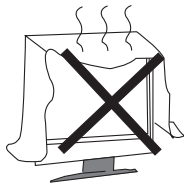

Caution

Avoid exposing the main unit to direct sunlight and other sources of heat. Do not position television receiver directly on other products which give off heat. E.g. Video cassette players, audio amplifiers. Do not block the ventilation holes in the back cover. Ventilation is essential to prevent electrical failure. Do not squash power supply cord under the main unit.



Caution

The panel used in this product is made of glass. It can break when the product is dropped or applied with force.

Individuals should execute caution when dealing with broken glass should the panel break.



- Place the TV on a firm and flat surface, leaving a space of at least 10cm around the set and 30cm from the top of the set to the wall or cabinet. Ensure the TV is positioned close to the wall to avoid it falling when pushed.

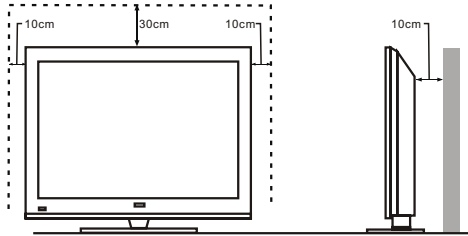

- When you turning the TV set, do not hold the top side of the TV set, you should hold the bottom side.

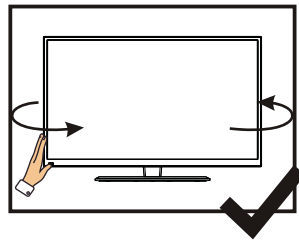
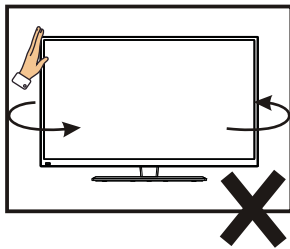

- When you lifting the TV set, do not use one hand to handle it, you should lift the TV set by two hands.

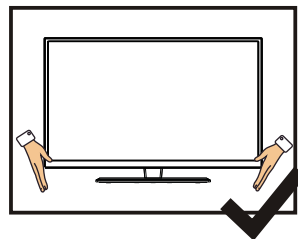
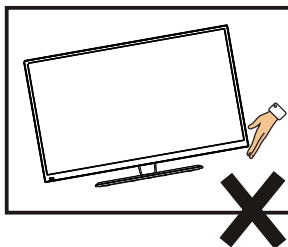

LED COLOR TV

CONTENTS

1. Connection and Preparation of TV.....	2
1.1 Accessories	2
1.2 Installation of Stand.....	2
1.3 Keys and Interfaces.....	3
1.4 Remote Control.....	4
1.5 Installation of Batteries.....	5
2. Basic Operation.....	5
2.1 Power ON/OFF(Optional).....	5
2.2 Setting of Standby Mode.....	5
3. Home page.....	6
4. TV Setting	7
5. Media.....	15
6. Technical Specification.....	17
7. Support Signal Modes.....	18
8. Simple Troubleshooting	19

LED COLOR TV

1.Connection and Preparation of TV

1.1 Accessories

- ★ User Manual
- ★ Remote Control
- ★ Battery(UM-4/R03P/AAA)
- ★ Wall Mount Kit (Pre-assembled)(Optional)

1.2 Installation of Stand

(For the physical structure, please refer to the real object)

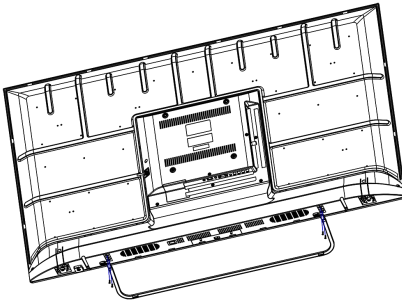

- ① Place the TV with the front panel facing downwards on the soft cloth or soft pads on a desk.
- ② Insert the stand into the bottom socket of the TV.
- ③ Insert the screws into the sockets and tighten them.

LED COLOR TV

1.3 Keys and Interfaces

The design and specification takes actual products as the standard

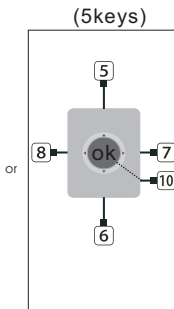
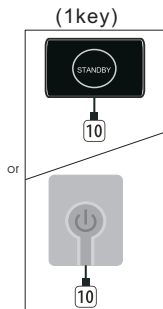
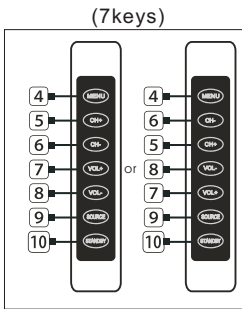
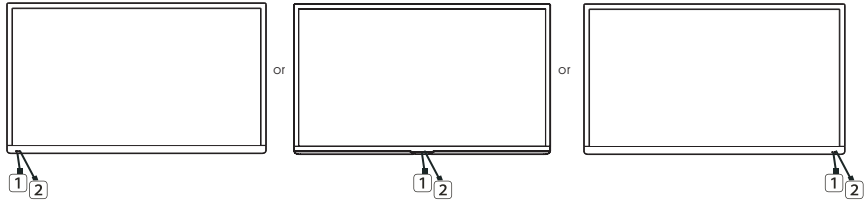

1. REMOTE SENSOR WINDOW
2. POWER INDICATOR
3. SPEAKER
4. MENU KEY
5. PROGRAM “+” KEY
6. PROGRAM “-” KEY
7. VOLUME “+” KEY
8. VOLUME “-” KEY
9. SOURCE KEY
10. STANDBYKEY
11. POWERPLUG INPUT

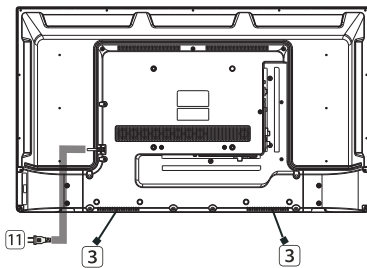

HDMI3	HDMI2 (ARC)	HDMI1	USB2 USB1 5V===500mA	EARPHONE
RJ45	OPTICAL	VIDEO	RF IN (S2) 13V/18V===500mA	RF IN (T2)
		AV IN L R		

LED COLOR TV

1.4 Remote Control

(Here is only the sketch, please in kind prevail)



For buttons with #, please long-press (hold for more than a second).

POWER: ON/OFF.

(STB POWER) You can turn on/off the power of the set-top box.

0-9: Number selection key.

0#: The QUICK ACCESS edit screen appears.

LIST: Checking the saved programmes.

...: It displays the additional buttons on the remote control.

...#: Audibly describes the contents of the screen.

: It adjusts the volume level.

: Select to turn off the sound from the TV.

#: Enter the Accessibility menu.

: You can change the programme.

: Check out the recommended contents. (Recommendation service may not be available depending on the countries you are in.)

Push and hold the button while speaking to use the voice recognition function.

: Displays the Home menu.

#: Displays the list used previously.

: Enters the Quick Settings menu.

#: Enters the All Settings menu.

Wheel (OK) : Press the center of the Wheel button to select a menu. You can change channels by using the wheel button.

△▽◀▶ (up/down/left/right) Press the up, down, left or right button to scroll the menu. If you press △▽◀▶ buttons while the pointer is in use, the pointer will disappear from the screen and Magic Remote will operate like a general remote control. To display the pointer on the screen again, shake Magic Remote the left and right.

: Move to the previous step.

: Closes the menu.

: You can check the programme.

NETFLIX : go to Netflix.

: Selects an input source.

#: Entering into the Home Dashboard.

prime video : go to prime video.

These access special functions in some menus.

MOVIES: Search Movies.

: Play.

: Pause.

LED COLOR TV

1.5 Installation of Batteries

(Here is only the sketch, please in kind prevail)

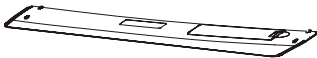
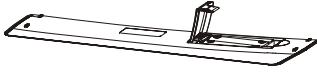

- ① Open the back lid of the remote control.
- ② Install two 7#(AAA)1.5V batteries.
Ensure the correct polarity of the batteries.
- ③ Cover the back lid.
Please take out of the batteries from the remote control for long time of no use.

If the remote control doesn't work properly, please carry out the following checks.

- Check the TV is turned on.
- Check the polarity of the batteries are correct.
- Check the batteries are not drained.
- Check the power supply is normal or the power cord is correctly connected.
- Check there are no special fluorescent light or neon light around.



2. Basic Operation

2.1 Power ON/OFF(Optional)

- Connect the power cord to the **AC input**. Insert the power cord into the appropriate socket.
- Press the **Power switch** to switch on the TV, then press **Power** button to turn on the unit.
- Press the **Power switch** again to switch off the TV.

Note: After switch off the TV, please don't immediately re-open the power switch ,should be delayed one minute more to re-open the power switch.

2.2 Setting of Standby Mode

- Press () button to turn on the unit.
- Press () button again to return the display to standby mode. The power indicator turns red.
- Be sure not to set your TV in standby mode for a long period of time.

LED COLOR TV

3. Home page

Enter the Home page after First Time install.

In the list of apps, select the app you want to enter.

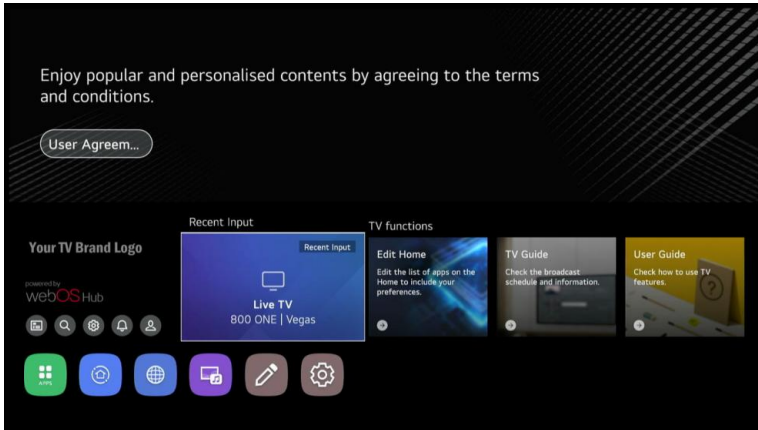

Using Home Hub

Press ▼ / ▲ / ◀ / ▶ button to select Home Hub or press INPUT button to use Home Hub. You can select or control a device (mobile, Bluetooth, external device, etc.) connected to the TV.

Press ▼ / ▲ / ◀ / ▶ button to select .

TV/Input

1. You can play sound from a smart device connected via Bluetooth.

Please refer to Connecting External Devices → Playing Sound from a Smart Device through the TV's Speakers in User Guide for more information on the action.

2. You can check and select the external device connected through the external input port or network.

Connect Mobile Device

You can check and select the smart device connected with the LG ThinQ app.

Please refer to Connecting External Devices → Connecting Smart Devices in User Guide for more information on the action.

LED COLOR TV

4. TV Setting

Press **MENU** button to enter the TV Setting.

Press **▼ / ▲ / ◀ / ▶** button to highlight the desired menu icon , and press **OK** button to select.

Quick Settings



- ① You can set **Picture Mode**.
- ② You can set **Panel Brightness**.
- ③ You can set **Sound Mode**.
- ④ You can choose **Sound Out**.
- ⑤ You can choose **Sleep Timer**.
- ⑥ You can choose **Screen Off**.
- ⑦ You can set **Game Optimizer**.
- ⑧ You can add/delete the quick setting items or change their order.

All Settings

Press **▼ / ▲ / ◀ / ▶** button to select the All Settings 

Press the **<OK>** key to enter the sub-menu.

Press **▼ / ▲** button to select Picture/Sound/General/Support.

LED COLOR TV

Picture

Press ▼ / ▲ button to select Picture. Press **OK** button to enter sub-menu and setup.

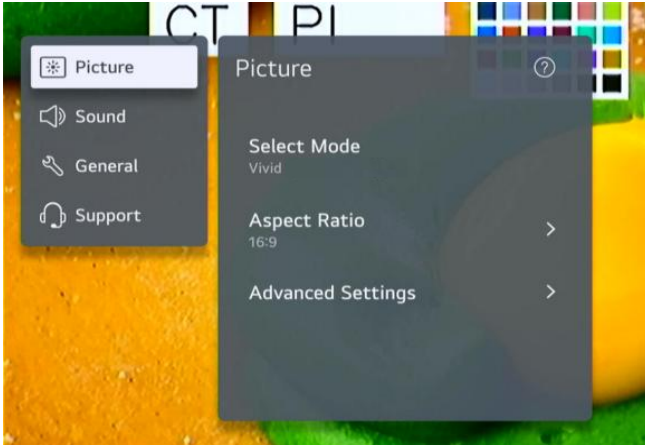

Select Mode

Press ▼ / ▲ button to select the Select Mode.

Press the <OK> key to enter the sub-menu.

Press ▼ / ▲ button to select Vivid/Standard/Basic/Cinema/Sports/Game Optimiser.

Aspect Ratio

You can change the screen size according to the type of content you are watching.

Press ▼ / ▲ button to select User Selection/ Just Scan.

User Selection

Press ▼ / ▲ button to select Aspect Ratio.

Just Scan

Press ▼ / ▲ button to select Just Scan.

If you turn this feature **On**, you can view the content in the aspect ratio that is in the broadcast signal or content source. If the edge of the screen is not clean, please turn it **Off**.

Advanced Settings

Press ▼ / ▲ button to select the Advanced Settings.

Press the <OK> key to enter the sub-menu.

Press ▼ / ▲ button to select Brightness/Color/Clarity/Apply to all inputs/Reset.

LED COLOR TV

Sound

Press ▼ / ▲ button to select Sound. Press **OK** button to enter sub-menu and setup.



Select Mode

Press ▼ / ▲ button to select the Select Mode.

Press the <OK> key to enter the sub-menu.

Press ▼ / ▲ button to select.

Sound Out

Press ▼ / ▲ button to select the Sound Out.

Press the <OK> key to enter the sub-menu.

Press ▼ / ▲ button to select

Advanced Settings

Press ▼ / ▲ button to select the Advanced Settings.

Press the <OK> key to enter the sub-menu

Press ▼ / ▲ button to select.

Balance

Balanced left and right channels.

Press **OK** button to select Balance. Press ▼ / ▲ button to adjust.

LED COLOR TV

Equalizer

Press ▼ / ▲ button on to select Equalizer.

Press OK button to enter sub-menu then press ▼ / ▲ ◀ / ▶ button to adjust.

Apply to All Inputs

Press ▼ / ▲ button on to select Apply to All Inputs.

Reset

You can reset the sound effect settings.

Press ▼ / ▲ button to select Reset.

Installation Type

Press ▼ / ▲ button on to select Installation Type.

Press ▼ / ▲ button to select Stand/ Wall-mounted.

Automatic Volume Adjustment

Press ▼ / ▲ button on to select Auto Volume. Press **OK** button to select On/Off.

DTV Audio Setting

Press ▼ / ▲ button on to select DTV Audio Setting.

Press ▼ / ▲ button to select MPEG/ Dolby Digital/ Dolby Digital Plus/ HE-AAC/ Auto.

Match Screen and Sound

Press ▼ / ▲ button on to select Match Screen and Sound.

Select HDMI Input Audio Format

Press ▼ / ▲ button on to select HDMI Input Audio Format.

You can set the audio format for each HDMI input. When the voice delivered through the HDMI port is not synchronized, set it to **PCM**.

Digital Sound Output

Press ▼ / ▲ button on to select Digital Sound Out.

eARC Support

Press ▼ / ▲ button on to select eARC Support.

LED COLOR TV

General

Press ▼ / ▲ button to select General. Press **OK** button to enter sub-menu and setup.

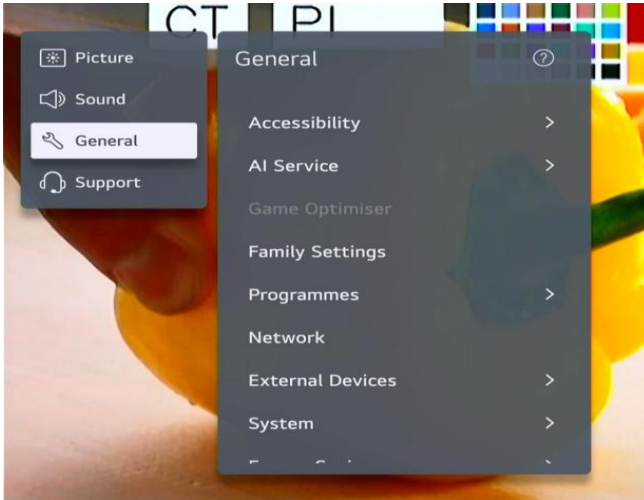

Accessibility

Press ▼ / ▲ button to select Accessibility. Press **OK** button to enter sub-menu.

Audio Description Volume

Press ▼ / ▲ button to select Audio Description volume . Press **OK** button to select.

Learn Remote Control

Press ▼ / ▲ button to select Learn Remote Control.

Enjoy TV Sound Together

Press ▼ / ▲ button to select Enjoy TV Sound Together. Press ▼ / ▲ button to select.

Hard of Hearing

Press ▼ / ▲ button to select Hard of Hearing. Press **OK** button to select On/Off.

Subtitles

Press ▼ / ▲ button to select Subtitles. Press ▼ / ▲ button to select Subtitle First Choice Language and Subtitle Second Choice Language and press **OK** button to setup the language.

LED COLOR TV

High Contrast

Press ▼ / ▲ button to select High Contrast. Press OK button to select On/Off.

Greyscale

Press ▼ / ▲ button to select Greyscale. Press OK button to select On/Off.

Invert Colours

Press ▼ / ▲ button to select Invert Colours. Press OK button to select On/Off.

AI Service

You can enable the recommended services based on the usage history.

Press ▼ / ▲ button to select AI Service. Press OK button to enter sub-menu.

Game Optimizer

Press ▼ / ▲ button on to select Game Optimizer.

Family Settings

Press ▼ / ▲ button on to select Family Settings.

Press ◀ / ▶ button to select Usage Limit Setting/ Eye Care Mode/ Volume Limit Mode/ Screen Time Report. Press OK button to enter sub-menu. Press OK button to enable the function.

Programmes

Press ▼ / ▲ button on to select Programmes. Press OK button to enter sub-menu.

Network

Press ▼ / ▲ button on to select Network.

External Devices

Press ▼ / ▲ button on to select External Devices. Press OK button to enter sub-menu.

System

Press ▼ / ▲ button on to select System. Press **OK** button to enter sub-menu and setup.

Language

You can choose the menu language displayed on the screen and the audio language of the digital broadcast.

Press ▼ / ▲ button to select Language. Press OK button to enter sub-menu.

LED COLOR TV

Location

You can change the location setting of your Smart TV.

Press ▼ / ▲ button to select Location. Press OK button to enter sub-menu.

Time & Timer

You can check the time or configure related settings.

Press ▼ / ▲ button to select Time. Press **OK** button to enter sub-menu.

Safety

Press ▼ / ▲ button to select Safety. Press OK button to enter sub-menu.

All the Options are available only when the Safety select On.

The initial password is set as "0000".

Press ▼ / ▲ button to select the option then press **OK** button to setup.

Additional Settings

Press ▼ / ▲ button to select Additional Settings. Press OK button to enter sub-menu.

Reset to Initial Settings

Press ▼ / ▲ button to select Reset to Initial Settings. Press OK button to enter sub-menu.

Return TV to its initial settings. This will revert all settings to their default values.

After reset, the TV will automatically turn off and on.

Note: If Safety is set to On, you should type the password to Reset to Initial Settings.

Energy Saving

Reduces power consumption by adjusting screen brightness.

Press ▼ / ▲ button to select.

LED COLOR TV

Support

Highlight the item and press OK button to enter the sub-menu.

Press ▼ / ▲ button to select Support.

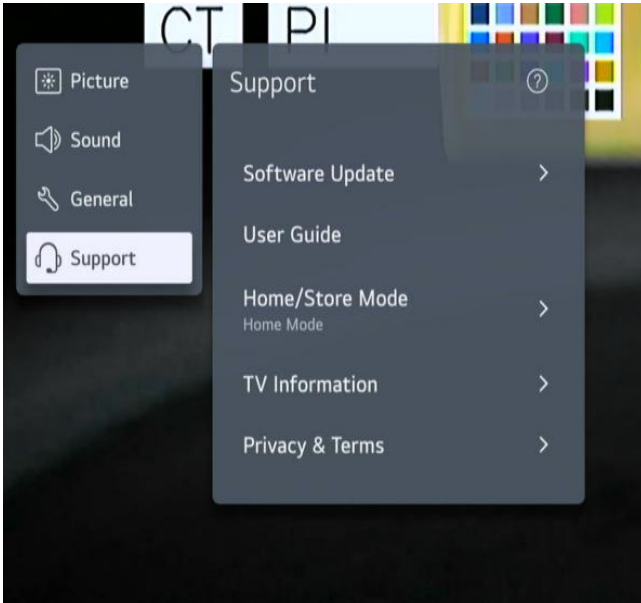

Software Update

Uses software update to check and obtain the latest version.

Press ▼ / ▲ button to select Software Update. Press **OK** button to enter sub-menu.

Then press ▼ / ▲ button to select and setup.

User Guide

Press ▼ / ▲ button to select User Guide. Press **OK** button to enter sub-menu.

Then press ▼ / ▲ button to select and setup.

Home/Store Mode

Press ▼ / ▲ button to select Home/Store Mode. Press **OK** button to enter sub-menu.

Then press ▼ / ▲ button to select and setup.

TV Information

Press ▼ / ▲ button to select TV Information.

Privacy & Terms

Press ▼ / ▲ button to select Privacy & Terms. Press **OK** button to enter sub-menu.

Then press ▼ / ▲ button to select and setup.

LED COLOR TV

5. Media

Connect a USB storage device (USB HDD, USB stick) to the USB port on the TV to enjoy the content files stored on the USB storage device on your TV.

Press ▼ / ▲ button on to select Photo & Video/Photo/Video/Music.

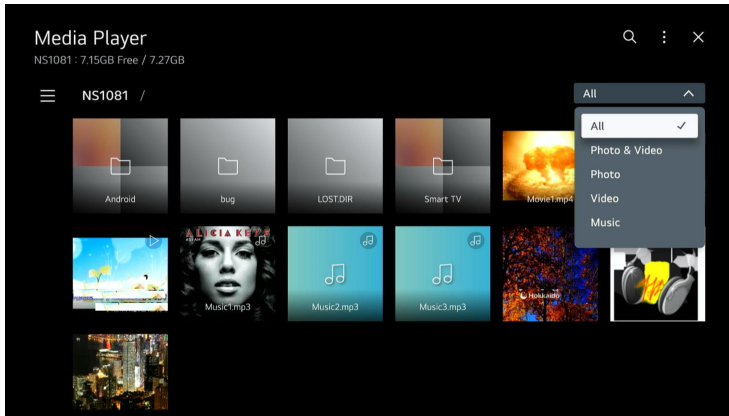

Photo

Selecting a photo in the Photo & Video app runs the photo player. You can view your saved photos.

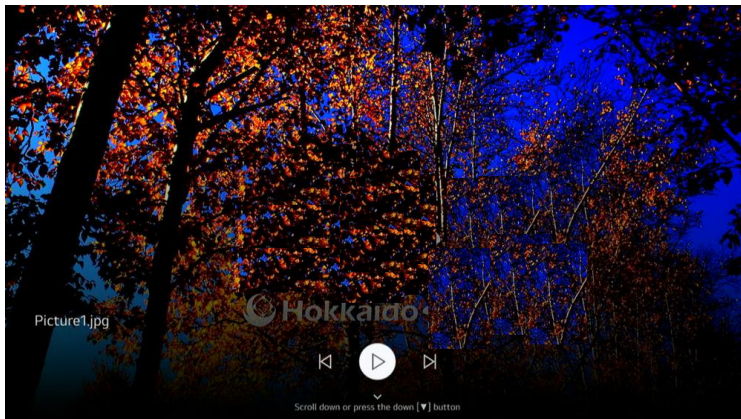

LED COLOR TV

Video

Selecting a video in the Photo & Video app runs the video player. You can view your saved videos.

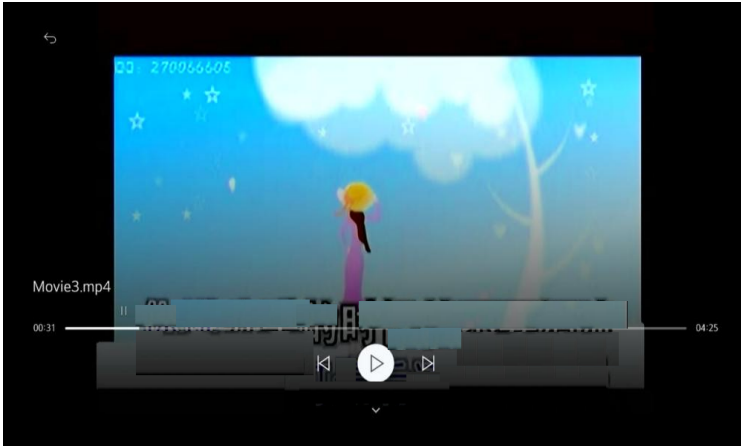

Music

You can play music conveniently by selecting the music files saved in the Music app or by selecting the music player icon during content playback in apps such as Photo & Video.

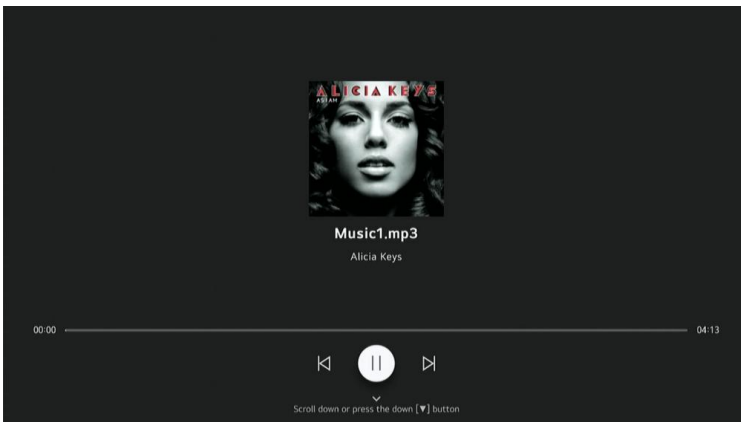

LED COLOR TV

6. Technical Specification

Product Model	32WOS640E	
Screen Size	32" diagonal	
Aspect Ratio	16:9	
Power Supply	AC 100-240V~,50/60Hz	
Power Consumption	60W	
TV System	PAL B/GD/K I,SECAM B/G D/K DVB-T/T2/C/S/S2(s/s2 option) (There is no DVB-C signal in some Countries or Areas.)	
Audio Output Power (Internal)	8Wx2	
Input Terminal	Antenna Input	x2 (S2 option)
	USB Input	x 2
	HDMI Input	x 3
	VGA Input	NO
	PC AUDIO Input	NO
	Audio Input (L/R)	x 1
	Video Input	x 1
	YPbPr Input	NO
	RJ45 Input	x 1
	CI card In	NO
	SCART In/Output	NO
	DC In (12V)	NO
CARD SLOT	NO	
Output Terminal	Earphone	x 1
	Audio Line Out(L/R)	NO
	Video Output	NO
	Optical	x 1
	Coaxial out	NO
Working Temperature	0°C~40°C	
Working Humidity	20% ~ 80% Non-condensing	

Note:the specification shown above may change without notice for quality improvement.

LED COLOR TV

7. Supported Signal Modes

A.HDMI Mode

Resolution	Horizontal Frequency (Khz)	Vertical Frequency (Hz)
480p	31.468	59.94
576p	31.25	50.00
720P	45.00	60.00
1080i	33.75	60.00
1080P(1920x1080)	67.50	60.00

-When the signal received by the Display exceeds the allowed range, a warning message will appear on the screen.

-You can confirm the input signal format onscreen.

LED COLOR TV

8. Simple Troubleshooting

If the display fails or the performance changes dramatically, check the display in accordance with the following instructions. Remember to check the peripherals to pinpoint the source of the failure.

Symptom	Solution
Power cannot be turned on.(Power indicator does not light.)	-Check that both ends of the power cable are plugged into the socket appropriately and the wall socket is operational
No Input Signal message appears.	-Check that the signal line is connected properly. -Check that the power of the relevant peripherals is turned on. -Check that the Input option that has been selected matches with the input signal.
The remote control does not function properly.	-Check the batteries are not drained.(Use new batteries.) -Check that the remote control is within the operating range. -Check that the remote control is pointed to the remote control window on the display. -Check that there are no obstacles between the remote control and the remote control window.
Flashing spots or stripes appear on the screen.	-Check that there are no emission (Car, HV cable or Neon lamp) or other possible interference sources.
Image colour or quality deteriorates.	-Check that all the video settings are adjusted appropriately, such as brightness, contrast, colour etc. -For more information about video settings, refer to OSD Functions in Chapter 2.
Screen position and size are incorrect.	-Check that the screen position and size is adjusted appropriately.
Image or colour is incorrect.	-Check that the signal line is connected properly. -When connecting to a PC, you can change the resolution of the PC to acquire the correct image. The discrepancy of the PC output signal may affect the display of the image.
Display warning message.	-Check that the input signal line is properly fixed. -Select the correct input signal. -For more information, refer to Supported Signal Modes in Chapter 4.



И 035 24

Nadamo se da ste pažljivo pročitali uputstva i da ćete ih se pridržavati.
Za više informacija o FOX uređajima posetite našu internet stranicu:

www.foxelectronics.rs