

包装通知单

送至部门: 彩电工程部 _____ 生产计划部 _____ 销售中心 _____
采购中心 _____ 彩电物料部 _____ 彩电生产部 _____ 质量中心 _____

图纸编号 65-
客户名称 福布斯
订单号 237052
客户牌子 FOX
CPU 513-A40(EU)

主题: 说明书

说明: A5规格, 塞英合订本。

材质: 封面封底80g双胶纸彩色印刷, 内页70g双胶纸单色印刷。

制图:

美工审核:

美工批准:

结构审核:

电子审核:

DQA审核:



UPUTSTVO ZA UPOTREBU

LED TELEVIZORI

Model: 42AOS450E

Hvala Vam što ste kupili ovaj uređaj.

FOX LED televizori prepoznaju se po odličnim tehničkim karakteristikama, kao i modernom, funkcionalnom i elegantnom dizajnu. Osim toga konstantna unapređenja u vidu postprodajne

podrške, izuzetno efikasna i rasprostranjena servisna mreža čine da se ponosni vlasnici **FOX televizora** mogu osećati sigurno.

Napravili ste pravi izbor.



U nastavku slede uputstva za upotrebu. Nisu komplikovana, ali ih se morate pridržavati.

SR

VAŽNA BEZBEDONOSNA UPUTSTVA

UPOZORENJE

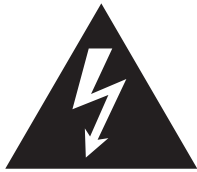
KAKO BISTE SPREČILI POŽAR ILI ELEKTRIČNI UDAR NEMOJTE KORISTITI PRODUŽNI KABL, DUPLI UTIKAČ ILI DRUGE DODATKE NA UTIČNICI OSIM ONIH KOJI BI MOGLI DA SPREČE IZAZIVANJE STRUJNOG UDARA. KAKO BISTE SPREČILI POŽAR ILI ELEKTRIČNI UDAR NE IZLAŽITE OVAJ UREĐAJ VLAZI ILI KIŠI.

 <p>Ovaj simbol munje u jednakostraničnom trouglu upozorava korisnike na prisustvo opasnog i ne izolovanog napona unutar kućišta proizvoda koji može biti dovoljan da stvori rizik STRUJNOG UDARA</p>	<p>CAUTION</p> <p>RISK OF ELECTRIC SHOCK DO NOT OPEN</p> <p>Upozorenje: Da biste smanjili rizik od strujnog udara nemojte skidati poklopac (ili zadnju stranu). Unutra nema delova koje korisnik može sam da zameni. Za obavljanje servisa zatražite pomoć kvalifikovanog osoblja.</p>	 <p>Znak uzvika unutar jednakostraničnog trougla u ovom uputstvu upozorava korisnika na prisustvo važnih instrukcija za rad i održavanje (servisiranje) uređaja.</p>
--	---	---

Ovaj aparat ne treba izlagati vodi, a predmete ispunjene tečnošću poput vaza ne treba da budu postavljeni na i oko uređaja.

OPREZ

Postoji opasnost od eksplozije ako se baterija nepropisno zameni.

Zamenite postojeću sa samo odgovarajućom vrstom baterije.

Nemojte izlagati bateriju direktnoj sunčevoj svetlosti ili bilo kojem drugom izvoru toplote.

Obezbedite pravilno odlaganje istrošenih baterija.

Ostavite lako dostupnim mesto gde je utikač ili nastavak za prekid napajanja.

Da biste smanjili rizik od strujnog udara, ne obavljajte bilo kakvo servisiranje osim onih koje se pominju u ovom uputstvu.

VAŽNE INFORMACIJE

Ako televizor nije postavljen na dovoljno stabilnom mestu, može postojati potencijalna opasnost od pada.

Mnoge povrede, posebno dečije, mogu se izbeći primenom jednostavnih mera opreza kao što su:

Korišćenje elemenata ili stalaka koje je preporučio proizvođač televizora.

Korišćenje samo onog nameštaja koji može sigurno izdržati uređaj.

Obezbeđivanje uređaja tako da ne prelazi ivicu nameštaja.

Nemojte postavljati TV na visok nameštaj (na primer, ormare ili police) bez prethodnog pričvršćivanja kako nameštaja tako i uređaja na odgovarajuću površinu.

Ne pokrivajte televizor krpom i ne stavljajte drugi materijal između televizora i nameštaja na kom on stoji.



Sigurna instalacija

Koristite pojas za fiksiranje televizora kako bi sprečili uređaj od pada unapred.



1. **Pročitajte uputstva**- Sve napomene o sigurnosti i načinu rada treba pročitati pre uključivanja aparata.
2. **Sačuvajte uputstva** – Uputstva za sigurnost i uputstvo za upotrebu treba da se sačuvaju za buduće potrebe.
3. **Imajte u vidu Upozorenja** – Treba se pridržavati svih upozorenja na aparatu i svih uputstava za upotrebu.
4. **Pratite uputstva**- Treba pratiti sva uputstva.



5. **Voda i vlažnost** – Aparat ne treba koristiti u blizini vode.
6. **Nosač i postolje** – Aparat treba koristiti samo sa nosačem ili postoljem koje preporučuje proizvođač
7. **Montaža na zid ili plafon** – Aparat treba da se montira na zid ili plafon samo po preporuci proizvođača.
8. **Ventilacija** – Aparat treba da bude dobro postavljen, tako da lokacija ili pozicija aparata ne ometaju njegovo provetranje.
9. **Toplota** – Ovaj aparat treba postaviti dalje od izvora toplote kao što su radijatori i peći.
10. **Napajanje** - Aparat treba povezati samo na napajanje kao što je opisano u uputstvima za upotrebu ili onako kako je naznačeno na uređaju.
11. **Uzemljenje ili polarizacija** – Treba preduzeti mere predostrožnosti.
12. **Zaštita kabla za napajanje** – Naponski kabl treba da bude usmeren tako da je malo verovatno da se može gaziti, priklješiti stvarima na njemu i njegovom kraju.
13. **Čišćenje** – Aparat bi trebalo čistiti samo po preporuci proizvođača.
14. Napajanje spoljne antene treba da se nalazi daleko od dalekovoda.
15. **Uzemljenje spoljne antene** – Ako je spoljna antena povezana na prijemnik, antenski sistem mora biti uzemljen kako bi se obezbedila zaštita od naponskog i izvornog statičkog elektriciteta.
16. **Kada ga dugo ne koristite** – napajanje uređaja trebalo bi da bude isključeno iz utičnice kada se ne koristi duži vremenski period.
17. **Upad predmeta i tečnosti** – Treba paziti da predmeti ne upadnu, a tečnost ne prospe u kućište kroz otvore.
18. **Kada je potreban servis** – Aparat treba da servisira kvalifikovano servisno osoblje kada su:
 - Kabal za struju ili utikač oštećeni.
 - Kada predmeti upadnu ili kada se tečnost prolje po uređaju
 - Kada je aparat izložen kiši
 - Kada aparat ne radi normalno ili pokazuje značajnu promenu u radu.
19. Ventilacioni otvori ne bi trebalo da budu pokriveni predmetima, kao sto su novine, tkanine, zavese itd.
20. Izvore otvorenog plamena, kao sto su upaljene sveće, ne bi trebalo da stoje na aparatu
21. Aparat će biti povezan sa mrežnom utičnicom sa zaštitnim uzemljenjem. Utičnica ili nastavak za prekid napajanja trebaju da budu lako dostupni.

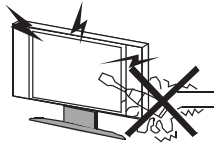

UPOZORENJE

Visok napon se koristi u napajanju ovog uređaja. Ne uklanjajte zadnji poklopac. Obratite se kvalifikovanoj osobi za obavljanje servisa.

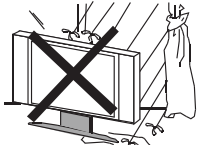

UPOZORENJE

Da biste sprečili požar ili strujni udar, nemojte izlagati uređaj kiši ili vlazi.



UPOZORENJE

Nemojte ispuštati i gurati predmete u kućište TV-a ili u otvore. Nikada nemojte prosipati tečnost na TV prijemnik.

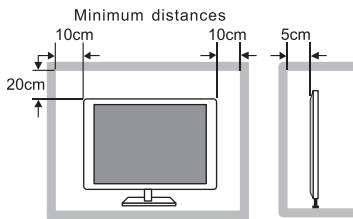

OPREZ

Ako televizor treba da se ugradi u zatvoreni odeljak ili na sličan način, morate se pridržavati dela uputstva o minimalnim udaljenostima. Toplota može smanjiti životni vek televizora, a takođe može biti povećan rizik od požara.



OPREZ

Nikada nemojte da stanete ili se oslonite ili gurnete uređaj ili stalak na kom se uređaj nalazi. Treba obratiti posebnu pažnju na decu.

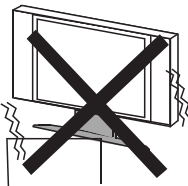

OPREZ

Ne stavljajte glavnu jedinicu na nestabilno postolje, policu ili sto. Usled pada može doći do ozbiljne povrede lica ili štete na televizoru.

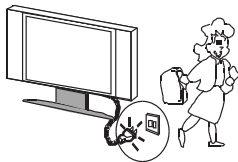

OPREZ

Kada se proizvod ne koristi duži vremenski period, preporučljivo je da isključite mrežni kabl iz utičnice .

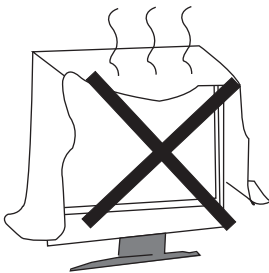

OPREZ

Izbegavajte izlaganje glavne jedinice direktnom suncu i drugim izvorima toplote. Ne postavljajte televizor na druge proizvode koji emituju toplotu. Na primer: Video uređaj, audio pojačala. Ne blokiraj otvore za ventilaciju u zadnjem poklopcu. Ventilacija je od suštinskog značaja za sprečavanje električnih kvarova. Ne stavljajte kabl za napajanje ispod glavne jedinice.



OPREZ

Panel (ekran) koji se koristi u ovom proizvodu napravljen je od stakla. Može se slomiti padom uređaja ili nasilnim udarcem. Pojedinci treba oprezno da rade sa razbijenim staklom ekrana.



- Postavite TV na stabilnu, ravnu površinu, ostavljajući najmanje 10 cm oko njega i 30 cm između vrha seta i zida ili ormarića. Da biste sprečili da se televizor prevrne kada ga gurnete, postavite ga blizu zida. Umesto da držite gornju stranu televizora kada ga okrećete, trebalo bi da držite donju stranu.

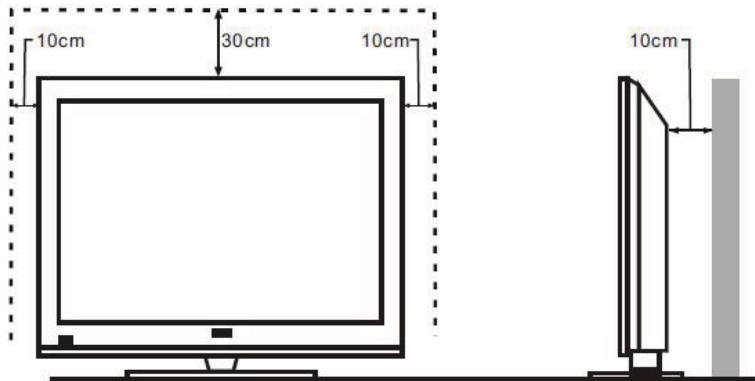

- Izbegavajte rukovanje televizorom samo jednom rukom kada ga podižete; umesto toga, koristite dve ruke.

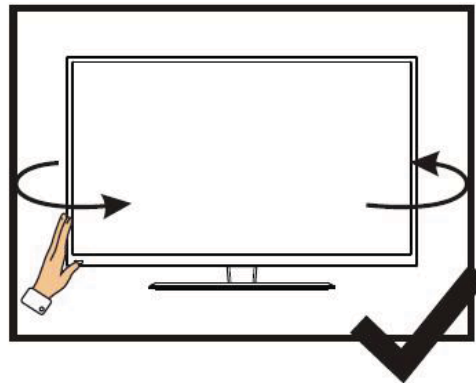
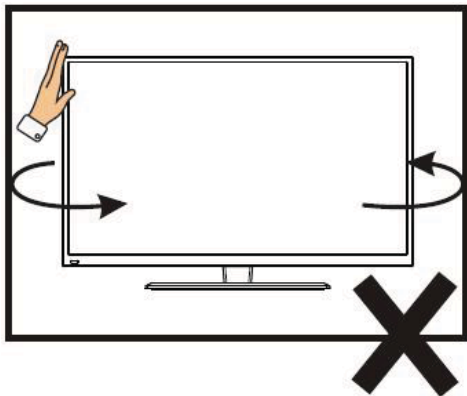

- Izbegavajte rukovanje televizorom samo jednom rukom kada ga podižete; umesto toga, koristite dve ruke.

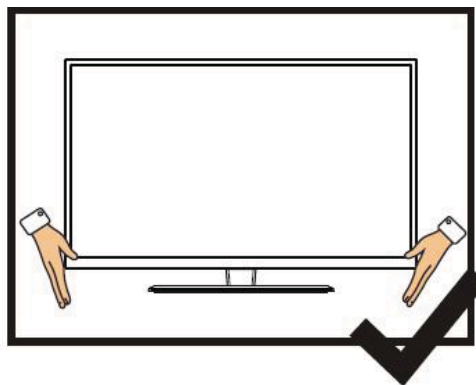
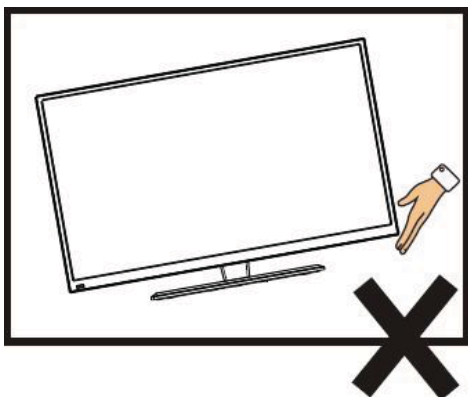

SADRŽAJ

1. Povezivanje i priprema TV-a	2
1.1 Pribor	2
1.2 Postavljanje postolja	2
1.3 Tasteri i interfejsi	3
1.4 Daljinski upravljač	4
1.5 Postavljanje baterija	5
2. Osnovni rad	5
2.1 UKLJUČIVANJE/ ISKLJUČIVANJE (opcionalno)	5
2.2 Postavljanje načina pripravnosti	5
2.3 Početna stranica	6
2.4 Postavke TV-a	8
2.5 Hotel Mode	9
2.6 Mediji	13
3. Tehničke specifikacije	17
4. Podržani načini signala	18
5. Jednostavno rešavanje problema	19

FOX LED TV

1 Priključivanje i priprema TV-a

1.1 Dodatna oprema

- ✧ Uputstvo za korišćenje
- ✧ Daljinsko upravljanje
- ✧ Baterija (UM-4/R03P/AAA)
- ✧ Komplet za montiranje na zid (unapred montiran) (opciono)

1.2 Instalacija postolja

(Molimo pogledajte stvarni objekat za detalje o fizičkoj strukturi.)

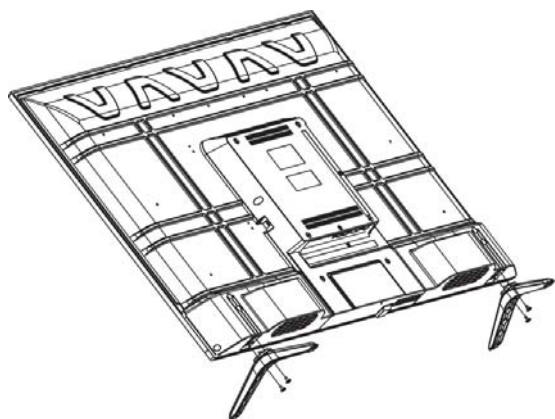

- 1) Postavite TV na mekanu tkaninu ili meke jastuke na sto tako da prednja ploča bude okrenuta nadole.
- 2) Stavite postolje u donju utičnicu televizora.
- 3) Zašrafite utičnice sa zavrtnjima na mestu, a zatim ih zategnite.

FOX LED TV

1.3 Tasteri i interfejsi

Stvarne stavke se koriste kao standard u dizajnu i specifikaciji.

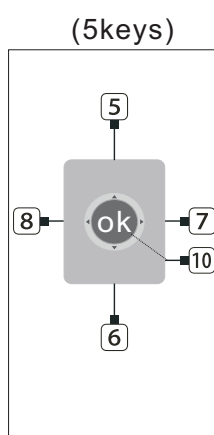
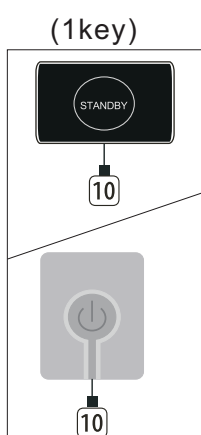
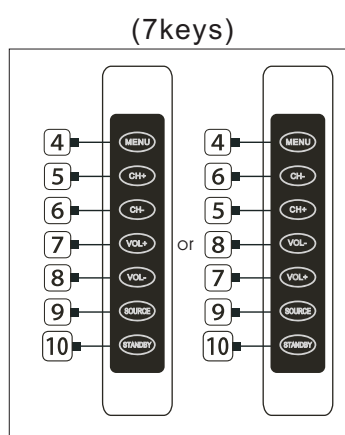
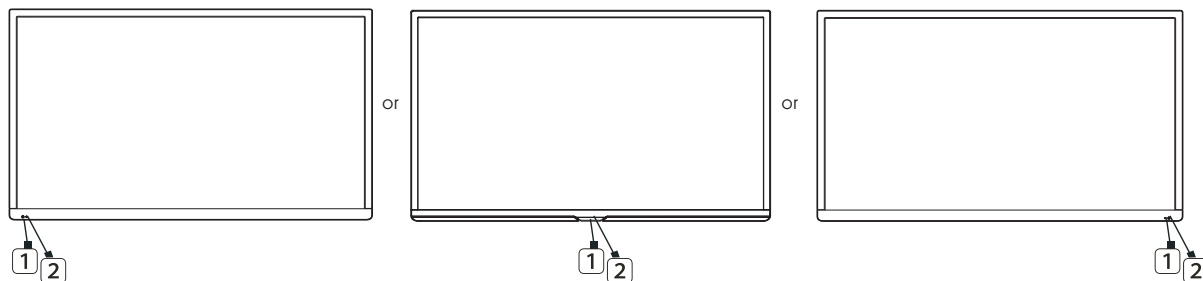

- 1 PROZOR DALJINSKOG SENZORA
- 2 INDIKATOR SNAGE
- 3 GOVORNIK
- 4 MENU DUGME
- 5 PROGRAM "+" DUGME
- 6 PROGRAM "+" DUGME
- 7 VOLUME "+" DUGME
- 8 VOLUME "-" DUGME
- 9 SOURCE DUGME
- 10 TASTER PRIPRAVNOSTI
- 11 ULAZ ZA NAPAJSANJE

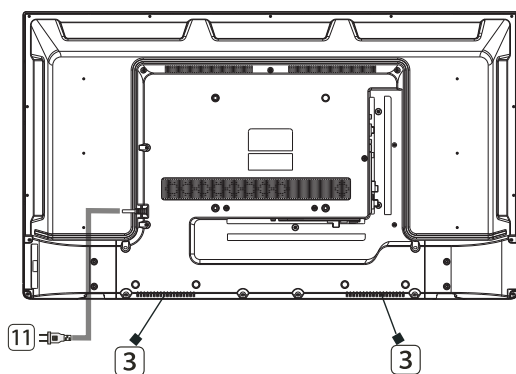

FOX LED TV

1.4 Daljinski upravljač (Ovde je samo skica, molimo Vas pregledajte)

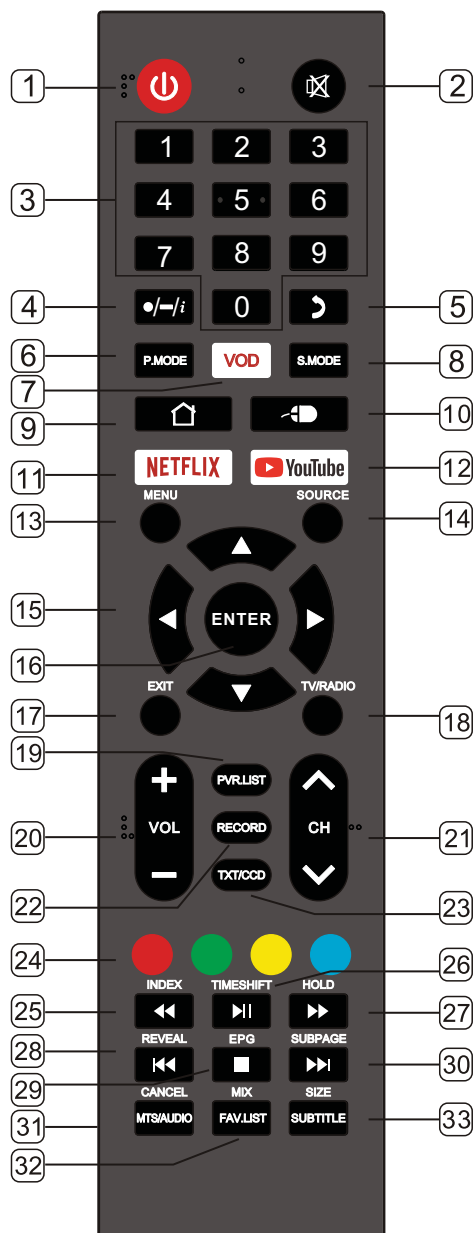

1. STANDBY(⏻): Stanje pripravnosti uključeno i isključeno
2. MUTE: Isključite zvuk
3. 0~9: Nastavite pritiskati tastere za odabir kanala.
4. ●/-/i
 - : Pritisnite ovo dugme za ulazak u broj programa s različitim ciframa. npr. 10.1, 10.2.
 - : Dugme s tačkom i manji broj kanala.
 - i: Prikažite informacije trenutnog video i audio zapisa.
5. RECALL: Povratak na prethodni kanal.
6. P.MODE: Odaberite način slike
7. VOD: Otvorite aplikaciju VOD s tipkom s kraticom.
(Napomena: Ako aplikacija VOD nije unapred postavljena, ova tipka kratice je nevažeća)
8. S.MODE: Odaberite način zvuka.
9. HOME: Uđite u početnu stranicu.
10. MOUSE: Uključite ili isključite miš s daljinskim upravljačem.
11. NETFLIX: Uđite u aplikaciju Netflix.
12. YouTube: Uđite u aplikaciju YouTube.
13. MENU: Uđite u meni ili izađite iz njega.
14. SOURCE: Odaberite izvor signala.
15. ▲,▼,◀,▶ key: Odabir stavke menija.
16. ENTER: Potvrdite ili uđite.
17. EXIT: Izađite iz menija ili radnje.
18. TV/RADIO: Odaberite TV ili način radija.
19. PVR.LIST: PVR lista.
VOL+: Povećajte jačinu.
VOL-: Smanjite jačinu.
20. CH^: Odaberite kanal napred.
CHV: Odaberite kanal natrag.
21. RECORD: USB disk s podacima beleženja načina DTV-a.
22. TXT: Uđite u teletext ili izađite iz njega.
Or CCD: Promenite CCD način.
23. RED: Pristupite crvenoj stavci ili stranici.
GREEN: Pristupite zelenoj stavci ili stranici.
YELLOW: Pristupite žutoj stavci ili stranici.
BLUE: Pristupite plavoj stavci ili stranici.
24. INDEX: Prikaz stranice indeksa.
25. MEDIA mode: ◀◀ Brzo kretanje nazad.
26. TIMESHIFT: Smena vremena načina DTV-a.
MEDIA mode: ▶▶: Pritisnite jednom za zaustavljanje, pritisnite ponovo za reprodukciju.
MEDIA mode: ▶▶ Brzo unapred
27. HOLD: Držite trenutnu stranicu.
MEDIA mode: ▶▶ Brzo unapred
28. REVEAL: Otkrijte skrivene informacije.
MEDIA Mode: ◀◀ Prethodno.
29. EPG: Uđite u EPG ili izađite iz njega (Elektronski vodič kroz program).
MEDIA mode: ■ Zaustavite reprodukciju i vratite se na listu datoteka.
30. SUBPAGE: Uđite u način podstranice.
MEDIA mode: ▶▶ Sledeće.
31. CANCEL(under TXT):otkažite TXT na zaslonu.
MTS/AUDIO:MTS: promenite MTS način.
or AUDIO:Odaberite TV audio način.
32. MIX(under TXT):postavljanje transparentnosti.
FAV.LIST:Lista omiljenih kanala.
33. SIZE(under TXT):Postavljanje veličina znakova.
SUBTITLE:DTV način Odaberite način titlovanja.

FOX LED TV

1.5 Instalacija baterija

(Molim vas da prevladate, ovo je samo skica.)



- 1 Zadnji poklopac daljinskog upravljača treba da bude otvoren.
- 2 Stavite dve 7# (AAA) 1.5V baterije u sistem.
Uverite se da su baterije pravilno polarizovane.
- 3 Pokrijte zadnji poklopac.

Izvadite baterije iz daljinskog upravljača ako ga neko vreme nije koristio.

Izvršite sledeće provere ako daljinski upravljač ne funkcioniše ispravno.

- Proverite da li je TV u programu.
- Proverite da li je polaritet baterija odgovarajući.
- Proverite da li baterije nisu iscrpljene.
- Uverite se da je napajanje u ispravnom stanju ili da je kabl za napajanje pravilno povezan.
- Uverite se da u blizini nema neobičnih neonskih ili fluorescentnih svetla.

2 Osnovna operacija

2.1 Uključivanje/isključivanje (opciono)

- Povežite kabl za napajanje sa **AC ulazni** . Utaknite kabl za napajanje u odgovarajuću utičnicu. - Pritisnite **Prekidač** da uključite TV, zatim pritisnite **Napajanje** dugme za uključivanje jedinice. - Pritisnite **Prekidač** ponovo da isključite TV.

Beleška: Nemojte odmah ponovo da otvarate prekidač za napajanje nakon što isključite TV; umesto toga, sačekajte jedan minut pre nego što ponovo otvorite prekidač za napajanje.

2.2 Podešavanje režima pripravnosti

- Pritisnite (⏻) dugme da biste uključili jedinicu.
- Pritisnite (⏻) dugme ponovo da vratite ekran u režim pripravnosti. Indikator napajanja svetli crveno.
- Uverite se da vaš TV nije ostavljen u režimu pripravnosti duži vremenski period.

2.3 Izbor režima unosa

Ovaj set sadrži više modova izvora signala; pritisnite dugme **Source** više puta da biste izabrali izvor signala.

FOX LED TV

2.3 Početna stranica

Sledi interfejs glavnog menija. Pritisnite ▼ / ▲ za prebacivanje stranice navigacije.

Početna stranica

Pritisnite taster < HOME > za ulazak u početnu stranicu.

Sadržaj ove stranice uključuje: Izvor TV programa, Cast, Media, Assistant, Settings i druge preporuke za kategorije.

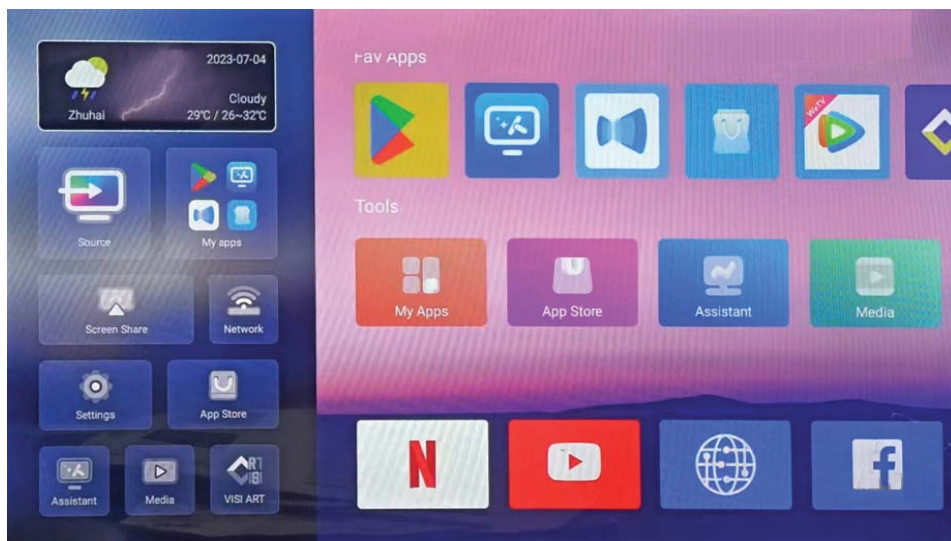

Podešavanja

Pritisnite ▼ / ▲ / ◀ / ▶ za odabir postavki i pritisnite < ENTER > za ulazak u stranicu postavki za sledeću radnju.

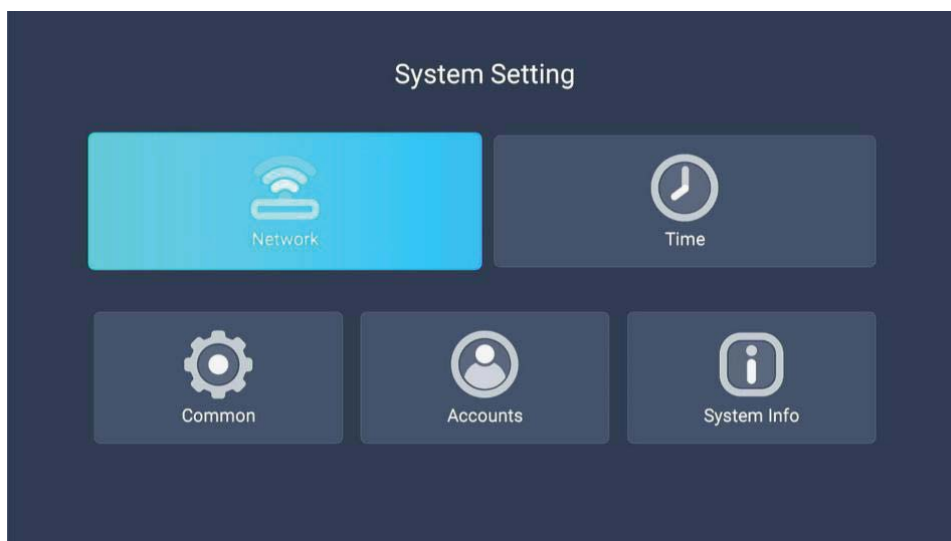

Zabeleška: Link za aplikacije i ulazni izvor predmet su detaljne narudžbe, gornja fotografija je samo za vašu referencu.

FOX LED TV

Mreža

Na stranici postavki pritisnite **▼/▲/◀/▶** za odabir mreže a zatim pritisnite < ENTER> za ulazak u stranicu mreže za sledeću radnju.

Vreme

Na stranici postavki pritisnite **▼/▲/◀/▶** za odabir vremena a zatim pritisnite < ENTER > za ulazak u stranicu vremena za sledeću radnju.

Uobičajeno

Na stranici postavki pritisnite **▼/▲/◀/▶** za odabir Uobičajeno a zatim pritisnite < ENTER > za ulazak u stranicu Uobičajeno za sledeću radnju.

Pritisnite **▼/▲** za odabir Jezik/ Način unosa/ Pozadina/ Oporavak sistema/ Naziv uređaja/ Licence otvorenih izvora/ Licence treće strane.

Jezik	Postavite jezik sistema na engleski kao zadano.
Način unosa	Postavite način unosa.
Pozadina	Podesite pozadinu.
Oporavak sistema	Vratite postavke sistema u izvorno stanje. Lozinka je 【4711】 .
Naziv uređaja	Postaviti Naziv uređaja.
Licence otvorenog izvora	Pregledajte licence otvorenog izvora.
Licence treće strane	Pregledajte licence treće strane

Računi

Na stranici postavki pritisnite **▼/▲/◀/▶** za odabir Računi a zatim pritisnite < ENTER > za ulazak u stranicu Računi za sledeću radnju. Na ovoj stranici možete dodati račun ili izaći iz trenutnog računa.

Informacije o sistemu

Na stranici postavki pritisnite **▼/▲/◀/▶** za odabir Informacije sistema a zatim pritisnite < ENTER > za ulazak u stranicu Informacije sistema za sledeću radnju. Na ovoj stranici možete da vidite informacije povezane sa sistemom

Omiljene aplikacije

Pritisnite **▼/▲** za odabir omiljenih aplikacija.

Ovde možete da vidite svoj lični softver i da odete u prodavaonicu aplikacija da biste preuzeli svoj omiljeni softver

FOX LED TV

2.4 Postavke TV-a

U interfejsu za pregled TV-a pritisnite dugme <Meni> u daljinskom upravljaču za ulazak u meni postavki TV-a. Pritisnite taster ◀/▶ na daljinskom upravljaču za odabir. Pritisnite taster <ENTER> na daljinskom upravljaču za ulazak.

Izvor

Pritisnite taster <Meni> za ulazak u Interfejs glavnog menija i pritisnite taster ◀/▶ za odabir menija Izvor.

U ovom interfejsu možete da pritisnete ▼/▲/◀/▶ < ENTER> za prebacivanje izvora signala.

Picture (Slika)

Pritisnite taster <Meni> za ulazak u Interfejs glavnog menija i pritisnite taster ◀/▶ za odabir menija Slika.

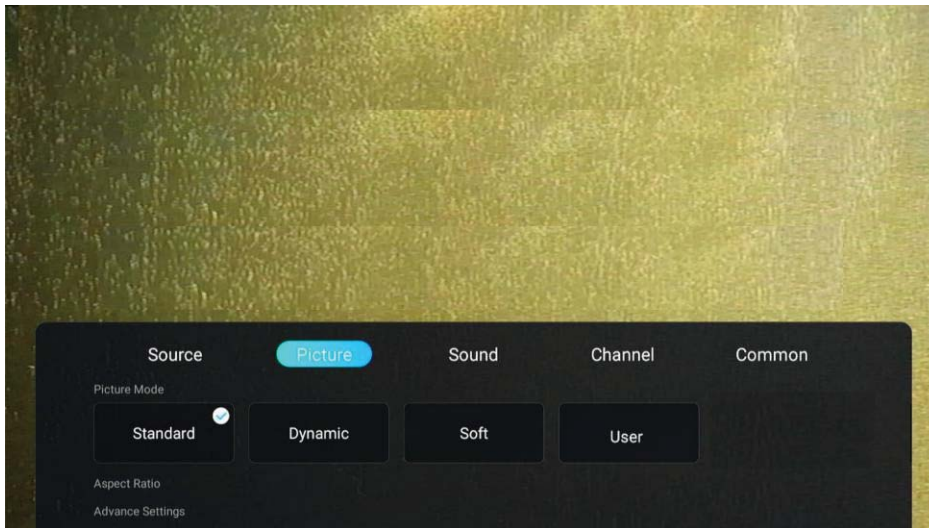

Način rada Slika

Pritisnite ▼/▲ za odabir načina rada Slika. Pritisnite ◀/▶ za odabir opcije načina slike.

Standard Efekt standardne slike.

Dinamično Povećajte kontrast, boju i oštrinu slike tako da slika bude u dinamičnom balansu boja.

FOX LED TV

Meko Smanjuje kontrast, svetlinu, boju i definiciju slike tako da slika izgleda meko.

Korisnik Odaberite prilagođene postavke slike.

Format prikaza

Pritisnite ▼/▲ za odabir Prospect Ratio . Pritisnite tastere ◀/▶ za odabir.

Napredne postavke

Pritisnite ▼/▲ za odabir Napredne postavke. Pritisnite tastere ◀/▶ za odabir.

Smanjenje buke

Postavlja opcije za intenzitet uklanjanja buke na slici.

Pritisnite taster ◀/▶ za odabir smanjenja buke, pritisnite taster < ENTER > za ulazak u stranicu odabira i pritisnite taster ◀/▶ za odabir.

Temperatura boje

Podešava opštu temperaturu slike.

Pritisnite taster ◀/▶ za odabir temperature boje, pritisnite taster < ENTER > za ulazak u stranicu odabira i pritisnite taster ◀/▶ za odabir.

Hladno Slika je zelena i plava, manje crvena i opšta boja je svetla. Slika je više sveža i elegantna.

Normalno Slika nije pristrana i boja je umerena.

Toplo Slika je crvena i zelena, manje plava i boja je više svetla i meka.

Pozadinsko svetlo

Pritisnite taster ◀/▶ za odabir pozadinskog svetla, pritisnite taster < ENTER > za ulazak u stranicu podešavanja i pritisnite taster ◀/▶ za podešavanje.

DLC

Pritisnite taster ◀/▶ za odabir DCL, pritisnite taster < ENTER > za ulazak u stranicu odabira i pritisnite tastere ◀/▶ za odabir.

2.5 Hotelski način rada

Pritisnite dugme **MENI** i pritisnite "7906 " u postavke Hotela.

FOX LED TV

Zvuk

Pritisnite taster <Meni> za ulazak u Interfejs glavnog menija i pritisnite taster ◀▶ za odabir menija Zvuk.

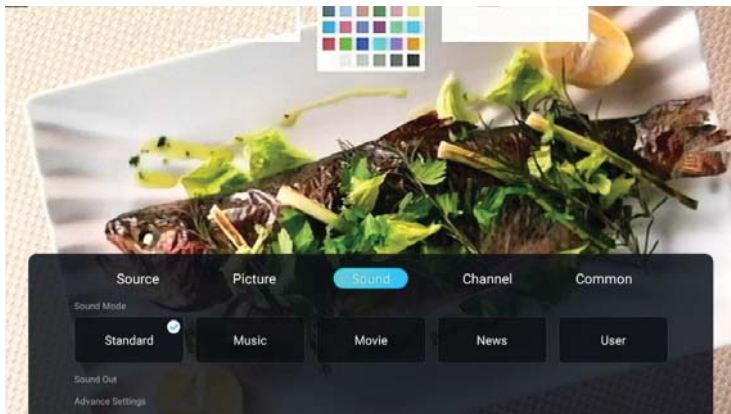

Način rada zvuka

Pritisnite ▼/▲ za odabir načina rada Zvuk. Pritisnite ◀▶ za odabir opcije načina zvuka.

- Standard Izbalansiran zvuk u bilo kom okruženju.
- Muzika Visoki tonovi su pojačani a basovi stišani.
- Film Pojačajte veću i manju visinu, bogatu melodijom i poboljšajte efekat na licu mesta.
- Novosti Poboljšajte glas.
- Korisnik Odaberite prilagođene postavke zvuka.

Izbacivanje zvuka

Pritisnite ▼/▲ za odabir načina rada Izbacivanje zvuka. Pritisnite ◀▶ za odabir opcije načina izbacivanja zvuka.

Napredne postavke

Pritisnite ▼/▲ za odabir Napredne postavke. Pritisnite tastere ◀▶ za odabir.

Balans

Podesite različite elemente frekvencije za kompenzaciju zvučnika i zvučnog polja.

Pritisnite tastere ◀▶ za odabir Balans, pritisnite taster < ENTER > za ulazak i pritisnite tastere ◀▶ za podešavanje.

AVC

Pritisnite tastere ◀▶ za odabir AVC-a i pritisnite taster < ENTER> za uključivanje/ isključivanje.

Nakon što se uključi „Automatsko kontrola jačine“, kada se jačina postavi, može da održava jačinu u zvučniku stabilnom bez obzira na to što je zvuk TV-a na svakom kanalu različit.

Lica s oštećenim sluhom

Pritisnite dugme ◀▶ za odabir Lica s oštećenim sluhom a zatim pritisnite taster < ENTER > za ulazak.

Audio Opis

Pritisnite dugme ◀▶ za odabir Audio opis a zatim pritisnite taster < ENTER > za ulazak.

AD Jačina

Pritisnite dugme ◀▶ za odabir AD Jačina. Pritisnite dugme < ENTER > za odabir.

FOX LED TV

Digitalni audio izlaz

Pritisnite tastere ◀/▶ za odabir Digitalni audio izlaz koji je, zadano, isključen.

Audio jezik

Pritisnite ◀/▶ za odabir Audio jezik i pritisnite dugme < ENTER > za odabir.

SPDIF odgoda

Pritisnite tastere ◀/▶ za odabir Digitalni SPDIF odgoda koji je, zadano, 0.

Okolina

Smer svakog izvora zvuka u originalnom signalu reproducira se da bi se korisnik osetio okružen zvukovima iz različitih smerova.

Pritisnite tastere ◀/▶ za odabir Okolina i pritisnite taster < ENTER>za uključivanje/ isključivanje.

Samo audio

Pritisnite taster ◀/▶ za odabir Samo audio i pritisnite taster < ENTER>za uključivanje/ isključivanje.

Kanal

Pritisnite taster <Meni> za ulazak u Interfejs glavnog menija i pritisnite taster ◀/▶ za odabir menija Kanal.

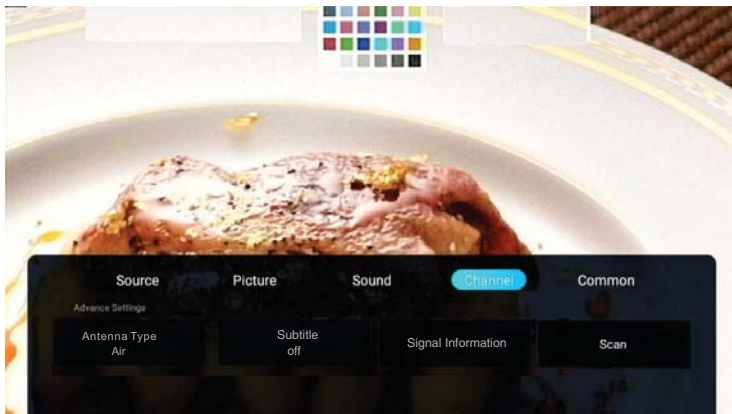

Vrsta antene

Pritisnite dugme ◀/▶ za odabir Vrsta antene i pritisnite taster < ENTER > za ulazak u odabir.

Podnaslov

Pritisnite dugme ◀/▶ za odabir Podnaslov a zatim pritisnite taster < ENTER > za ulazak.

Informacije o signalu

Pritisnite dugme ◀/▶ za odabir Informacije o signalu. Pritisnite dugme ENTER ◀/▶ za odabir pregleda.

Skenirati

Pritisnite tastere ◀/▶ za odabir Skenirati i pritisnite taster < ENTER>za ulazak.

Pritisnite ▼/▲ za odabir.

Lista kanala

Pregledajte sve postojeće programske kanale Pritisnite ▼/▲ za odabir liste kanala a zatim pritisnite ▶ za ulazak u podmeni.

EPG

Pritisnite dugme ◀/▶ za odabir EPG naslov a zatim pritisnite taster < ENTER > za ulazak.

CI kartica

Pritisnite dugme ◀/▶ za odabir CI kartica za pregled i postavljanje informacija o CI kartici.

FOX LED TV

Uobičajeno

Pritisnite taster <Meni> za ulazak u Interfejs glavnog menija i pritisnite taster ◀/▶ za odabir menija Uobičajeno.

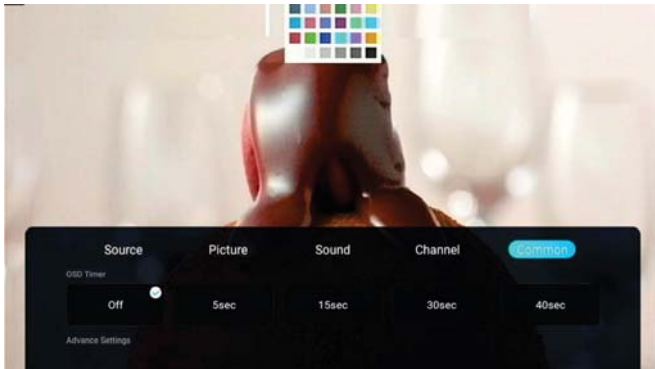

OSD Merač vremena Pritisnite ▼/▲ za odabir OSD merač vremena i pritisnite ◀/▶ za odabir.

Napredne postavke Pritisnite ▼/▲ za odabir Napredne postavke.

Merač vremena mirovanja

Pritisnite taster ◀/▶ za odabir Merač vremena mirovanja, pritisnite taster < ENTER > za ulazak i pritisnite taster ◀/▶ za odabir.

Uključen merač vremena Pritisnite dugme ◀/▶ za odabir Uključen merač vremena. Pritisnite dugme ◀/▶ za odabir.

Isključen merač vremena Pritisnite dugme ◀/▶ za odabir isključen merač vremena. Pritisnite dugme ◀/▶ za odabir.

Merač vremena automatskog stanja pripravnosti

Pritisnite taster ◀/▶ za odabir Merač vremena automatskog stanja pripravnosti i pritisnite taster < ENTER> za ulazak.

Letnje računanje vremena

Pritisnite dugme ◀/▶ za odabir Letnje računanje vremena a zatim pritisnite taster < ENTER > za ulazak.

Plavi ekran

Gde nema signala ekran će se prikazati plav.

Pritisnite taster ◀/▶ za odabir Plavi ekran i pritisnite taster < ENTER> za uključivanje/isključivanje.

ECO način

Pritisnite taster ◀/▶ za odabir ECO načina i pritisnite taster < ENTER> za uključivanje/isključivanje.

Teletext Pritisnite dugme ▼/▲ za odabir Teletext. Pritisnite dugme ◀/▶ za dabilir.

Audio jezik 1.

Pritisnite dugme ◀/▶ za odabir Audio jezik 1. Pritisnite dugme ENTER i ◀/▶ za odabir audio jezika.

Audio jezik 2.

Pritisnite dugme ◀/▶ za odabir Audio jezik 2. Pritisnite dugme ENTER i ◀/▶ za odabir audio jezika.

CEC

Pritisnite dugme ▼/▲ za odabir CEC a zatim pritisnite taster < ENTER > za ulazak u podmeni.

Pritisnite taster ◀/▶ <ENTER > u podmeniju za uključivanje ili isključivanje funkcija.

Zaključavanje

Pritisnite taster ◀/▶ za odabir Zaključati i pritisnite taster < ENTER> za ulazak. **lozinka je 【4711】.**

PVR Postavke Pritisnite dugme ▼/▲ za odabir PVR postavki. Pritisnite dugme ▼/▲ za odabir Odabrati.

Resetovanje menija

Vrati zadane postavke.

Pritisnite tastere ◀/▶ za odabir Resetovanje menija i pritisnite taster < ENTER> za odabir da li resetovati.

FOX LED TV

2.6 Mediji

Nakon umetanja USB uređaja sistem će izbaciti podsetnik da li da uđe u stranicu multimedija. Odaberite ENTER za ulaz.

Ako nema takve stranice možete da pritisnete tastere **▼/▲/◀/▶** za odabir medija a zatim pritisnite taster **< ENTER >** za ulazak u stranicu medija radi sledeće radnje.

Nakon ulaska, stranica se prikazuje kako sledi.

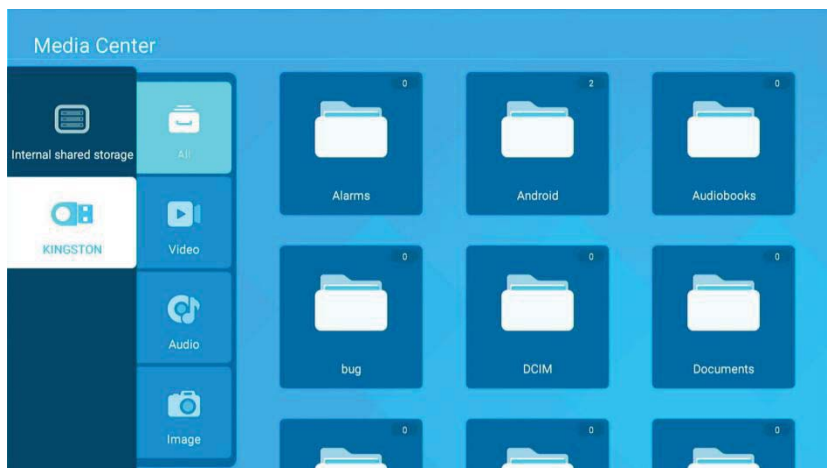

Video

Pritisnite **▼/▲** za odabir videa a zatim pritisnite **▼/▲/◀/▶** za odabir videa kojeg želite da pokrenete.

Pritisnite taster **<MENI>** za prikaz stranice na levom meniju.

Lista

Pritisnite taster **<Meni>** za ulazak u stranicu donjeg menija i pritisnite **◀/▶** za odabir liste.

Ova stranica pokazuje sve dostupne video zapise.

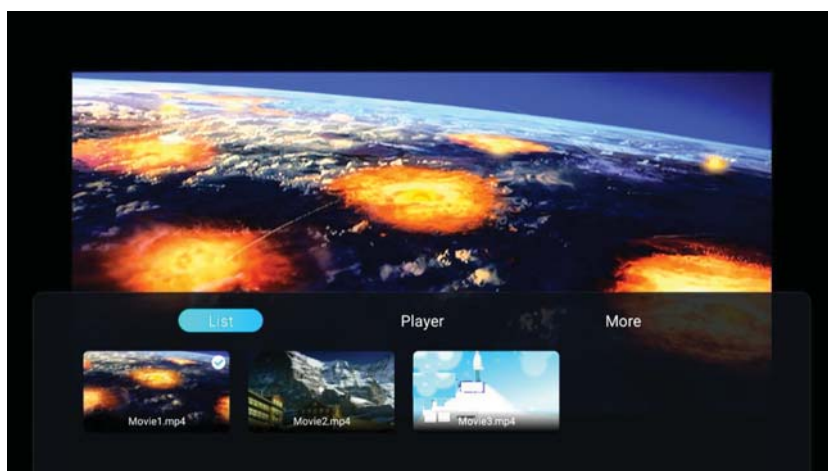

FOX LED TV

Plejer

Pritisnite taster <Meni> za ulazak u stranicu donjeg menija i pritisnite ◀/▶ za odabir plejera.

Način pokretanja

Pritisnite ▼/▲ za odabir načina pokretanja a zatim pritisnite ◀/▶ za odabir.

Aspect Ratio

Pritisnite ▼/▲ za odabir Aspect Ratio a zatim pritisnite ◀/▶ za odabir.

Napredne postavke

Pritisnite ▼/▲ za odabir Napredne postavke a zatim pritisnite ◀/▶ za odabir.

Audio zapis

Pritisnite ◀/▶ Audio zapis a zatim pritisnite <ENTER> za odabir.

Zapis podnaslova

Pritisnite ◀/▶ za odabir Zapis podnaslova a zatim pritisnite <ENTER> za odabir.

Jezik regije

Pritisnite ◀/▶ za odabir Jezik regije a zatim pritisnite <ENTER> za prikaz Svi regionalni jezici.

Vanjski podnaslov

Pritisnite ◀/▶ za odabir vanjskog podnaslova a zatim pritisnite <ENTER> za odabir vanjskog podnaslova kojeg želite da dodate.

Skok za napredak

Pritisnite ◀/▶ za odabir Skok za napredak a zatim pritisnite <ENTER> za odabir.

Uključi/ isključi prikaz liste

Pritisnite ◀/▶ za odabir uključenja/ isključenja prikaza liste i pritisnite taster < ENTER>za uključivanje/ isključivanje.

Informacije

Pritisnite ◀/▶ za odabir Informacije a zatim pritisnite <ENTER > za prikaz određenih informacija o trenutnom video zapisu.

Više

Pritisnite taster <Meni> za ulazak u stranicu donjeg menija i pritisnite ◀/▶ za odabir Više.

Pritisnite ▼/◀/▶ < ENTER > za odabir postavki slike ili postavki zvuka.

Postavke slike

Pritisnite ▼/◀/▶ za odabir postavki slike i pritisnite < ENTER > za ulazak u odgovarajuću stranicu postavki.

Postavke zvuka

Pritisnite ▼/◀/▶ za odabir postavki zvuka i pritisnite < ENTER > za ulazak u odgovarajuću stranicu postavki.

FOX LED TV

Audio

Pritisnite **▼/▲** za odabir Audio a zatim pritisnite **▼/▲/◀/▶** za odabir audio zapisa kojeg želite da pokrenete.

Pritisnite taster <MENI> za prikaz stranice na levom meniju.

Lista

Pritisnite taster <Meni> za ulazak u stranicu donjeg menija i pritisnite **◀/▶** za odabir liste.

Ova stranica pokazuje sve dostupne audio zapise.

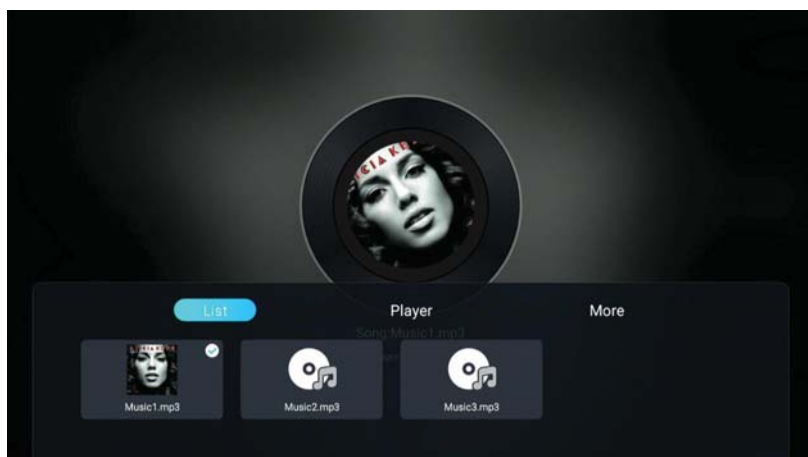

Plejer

Pritisnite taster <Meni> za ulazak u stranicu donjeg menija i pritisnite **◀/▶** za odabir plejera.

Način pokretanja

Pritisnite **▼/▲** za odabir načina pokretanja a zatim pritisnite **◀/▶** za odabir.

Napredne postavke

Pritisnite **▼/▲** za odabir Napredne postavke a zatim pritisnite **◀/▶** za odabir.

Skok za napredak

Pritisnite **◀/▶** za odabir Skok za napredak a zatim pritisnite <ENTER> za odabir.

Uključi/ isključi prikaz liste

Pritisnite taster **◀/▶** za odabir uključivanja/ isključivanja prikaza liste i pritisnite taster < ENTER> za uključivanje/ isključivanje.

Informacije

Pritisnite **◀/▶** za odabir Informacije a zatim pritisnite <ENTER > za prikaz određenih informacija o trenutnom audio zapisu.

Više

Pritisnite taster <Meni> za ulazak u stranicu donjeg menija i pritisnite **◀/▶** za odabir Više.

Pritisnite **▼/◀/▶** < ENTER > za odabir postavki slike ili postavki zvuka.

Postavke slike

Pritisnite **▼/◀/▶** za odabir postavki slike i pritisnite < ENTER > za ulazak u odgovarajuću stranicu postavki.

Postavke zvuka

Pritisnite **▼/◀/▶** za odabir postavki zvuka i pritisnite < ENTER > za ulazak u odgovarajuću stranicu postavki.

FOX LED TV

Slika

Pritisnite **▼/▲** za odabir slike a zatim pritisnite **▼/▲/◀/▶** za odabir slike koju želite da pokrenete. Pritisnite taster <MENI> za prikaz stranice na donjem meniju.

Lista

Pritisnite taster <Meni> za ulazak u stranicu donjeg menija i pritisnite **◀/▶** za odabir liste. Ova stranica pokazuje sve dostupne slike.

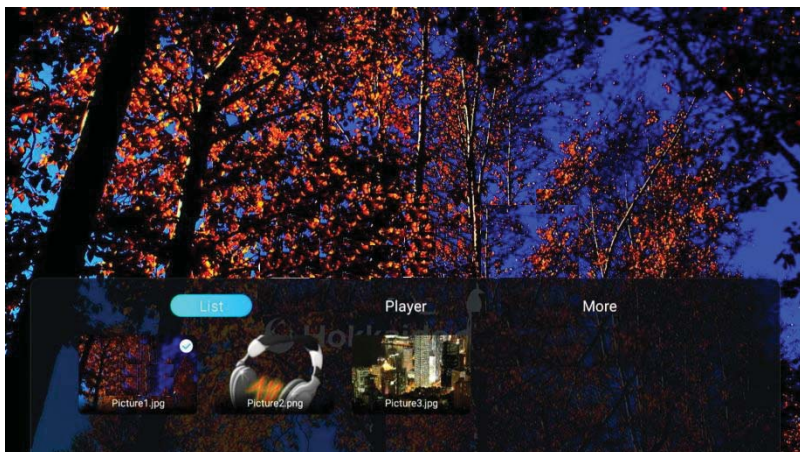

Plejer

Pritisnite taster <Meni> za ulazak u stranicu donjeg menija i pritisnite **◀/▶** za odabir plejera.

Format prikaza

Pritisnite **▼/▲** za odabir Aspect Ratio a zatim pritisnite **◀/▶** za odabir.

Okrenuti

Pritisnite **▼/▲** za odabir Okrenuti a zatim pritisnite **◀/▶** za odabir.

Napredne postavke

Pritisnite **▼/▲** za odabir Napredne postavke a zatim pritisnite **◀/▶** za odabir.

Pokrenite slajd

Pritisnite **◀/▶** za odabir Pokrenite slajd a zatim pritisnite <ENTER> za odabir.

Vreme intervala

Pritisnite **◀/▶** za odabir Vreme intervala i pritisnite < ENTER > za ulazak u odgovarajuću stranicu postavki.

Uključi/ isključi prikaz liste

Pritisnite **◀/▶** za odabir uključenja/ isključenja prikaza liste i pritisnite taster < ENTER>za uključivanje/ isključivanje.

Informacije

Pritisnite **◀/▶** za odabir Informacije a zatim pritisnite <ENTER > za prikaz određenih informacija o trenutnoj slici.

Više

Pritisnite taster <Meni> za ulazak u stranicu donjeg menija i pritisnite **◀/▶** za odabir Više.

Postavke slike

Pritisnite **▼/▲/▶** za odabir postavki slike i pritisnite < ENTER > za ulazak u odgovarajuću stranicu postavki.

Postavke zvuka

Pritisnite **▼/▲/▶** za odabir postavki zvuka i pritisnite < ENTER > za ulazak u odgovarajuću stranicu postavki.

FOX LED TV

3 . Tehnička specifikacija

Model proizvoda	42AOS450E	
Veličina ekrana	42" dijagonala	
Proporcija širine i visine	16:9	
Napajanje	AC 100-240V~,50/60Hz	
Potrošnja struje	75W	
TV sistem	PAL B/G D/K I,SECAM B/G D/K DVB-T/T2/C/S/S2 (opcija s/s2) (DVB-C signal je odsutan u nekim zemljama ili regionima.)	
Audio izlazna snaga (interna)	8Wx2	
Ulazni terminal	Antenski ulaz	x 2(S2 opcija)
	USB ulazni	x 2
	HDMI ulazni	x 3
	VGA ulazni	NE
	PC AUDIO ulazni	NE
	Audio ulazni (L/R)	x 1
	Video ulazni	x 1
	YPbPr ulazni	NE
	RJ45 ulazni	x 1
	Ulazni CI kartice	x 1
	SCART ulazni/izlazni	NE
	DC ulazni (12V)	NE
	KARTICE	NE
Izlazni terminal	Slušalica	x 1
	Audio linijski izlazni (L/R)	NE
	Video izlazni	NE
	Optički	NE
	Koaksijalni izlazni	x 1
Radna temperatura	0°C~40°C	
Radna vlažnost	20% ~ 80% Bez kondenzacije	

Beleška: Gore navedene karakteristike su podložne promeni bez upozorenja u cilju poboljšanja kvaliteta.

FOX LED TV

4. Podržani režimi signala

A. HDMI režim

Rezolucija	Horizontalna frekvencija (Khz)	Vertikalna frekvencija (Hz)
480p	31.468	59.94
576p	31.25	50.00
720P	45.00	60.00
1080i	33.75	60.00
1080P(1920x1080)	67. 50	60.00

- Poruka upozorenja će se pojaviti na ekranu ako je signal koji ekran prima izvan dozvoljenog opsega.

-Na ekranu možete proveriti format ulaznog signala.



The terms HDMI, HDMI High-Definition Multimedia Interface, HDMI trade dress and the HDMI Logos are trademarks or registered trademarks of HDMI Licensing Administrator, Inc.

5. Jednostavno otklanjanje poteškoća

Ako ekran pokvari ili se njegove performanse drastično promene, proverite ekran u skladu sa smernicama u nastavku. Ne zaboravite da pregledate periferne uređaje kako biste identifikovali koren problema.

Simptom	Rešenje
Napajanje se ne može aktivirati. (Indikator napajanja ne svetli.)	-Potvrdite da su oba kraja kabla za napajanje pravilno umetnuta u utičnicu i da li je zidna utičnica funkcionalna.
Prikazuje se poruka Nema ulaznog signala.	- Proverite da li je signalna linija ispravno povezana. -Potvrdite da su relevantni periferni uređaji uključeni. -Uverite se da izabrani izbor ulaza odgovara ulaznom signalu.
Daljinski upravljač ne radi ispravno.	-Proverite da baterije nisu istrošene. (Koristite novu bateriju.) -Potvrdite da daljinski upravljač radi u svom dometu. - Uverite se da je daljinski upravljač usmeren ka prozoru daljinskog upravljača ekrana. - Uverite se da nema prepreka između daljinskog upravljača i njegovog prozora.
Na ekranu se nalaze trepćuće tačke ili pruge.	- Uverite se da nema emisija (auto, VN žice ili neonske sijalice) ili drugih potencijalnih izvora smetnji.
Boja ili kvalitet slike se pogoršavaju.	- Proverite da li su sva video podešavanja, kao što su osvetljenost, kontrast i boja, pravilno podešena. -Za dodatne informacije o video postavkama, pogledajte OSD funkcije poglavlja 2.
Položaj i veličina ekrana su netačni.	-Potvrdite da su pozicija i veličina ekrana na odgovarajući način.
Slika ili boja su netačne.	- Proverite da li je signalna linija ispravno povezana. -Kada ste povezani sa računarom, možete da promenite rezoluciju računara da biste dobili odgovarajuću sliku. Disparitet u izlaznom signalu računara može uticati na prikaz slike.
Prikažite poruku upozorenja.	- Proverite da li je ulazna linija signala na odgovarajući način obezbeđena. -Izaberite odgovarajući ulazni signal. -Pogledajte Podržani režimi signala u poglavlju 4 za dodatne



USER MANUAL

LED Television Model: 42AOS450E

Thank you for purchasing this device.

FOX LED televisions are known for their great performance, as for modern, functional and elegant design. Besides that, we constantly improve our customer support, we have highly efficient and wide network of services, that make our proud customers feel safe.

You made a right choice.



Now it's time for instructions, they are not complicated, but you have to follow them.

EN

IMPORTANT SAFETY INSTRUCTIONS

WARNING

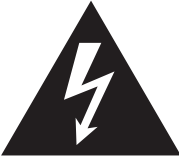
- TO PREVENT FIRE OR SHOCK HAZARD, DO NOT USE AN EXTENSION CORD, RECEPTACLE OR OTHER OUTLET UNLESS THE BLADES CAN BE TO PREVENT BLADE EXPOSURE.
- TO PREVENT FIRE OR SHOCK HAZARD, DO NOT EXPOSE THIS APPLIANCE TO RAIN OR MOISTURE.

 <p>This lightning flash with arrowhead symbol in an equilateral triangle alerts users to the presence of uninsulated dangerous voltage within the products enclosure that may be of sufficient magnitude to constitute a risk of electric shock.</p>	<h3>CAUTION</h3> <p>RISK OF ELECTRIC SHOCK DO NOT OPEN</p> <p>Warning: To reduce the risk of electric shock, do not remove cover (or back). No user serviceable parts inside. Refer servicing to qualified service personnel.</p>	 <p>The exclamation mark within an equilateral triangle alerts users to the presence of important operating and maintenance (servicing) instructions in the literature accompanying the appliance.</p>
--	--	---

This appliance should not be exposed to water and no object filled with liquid such as a vase should be placed on the unit.

CAUTION

- Danger of explosion if batteries are incorrectly replaced.
- Replace with only equivalent type of battery.
- Do not expose battery to direct sunlight or any other source of heat.
- Ensure proper disposal of used batteries.
- Where the MAINS plug or an appliance coupler is used as the disconnect device, the disconnect device shall remain readily operable.
- To reduce the risk of electric shock, do not perform any servicing other than what is mentioned in the operating manual.
- There are no user-serviceable parts inside the TV; do not open the TV casing.

IMPORTANT INFORMATION

If a television is not positioned in a sufficiently stable location, it can be potentially hazardous due to falling. Many injuries, particularly to children, can be avoided by taking simple precautions such as:

- Using cabinets or stands recommended by the manufacturer of the television.
- Only using furniture that can safely support the television.
- Ensuring the television is not overhanging the edge of the supporting furniture.
- Not placing the television on tall furniture (for example, cupboards or bookcases) without anchoring both the furniture and the television to a suitable support.
- Not standing the televisions on cloth or other materials placed between the television and supporting furniture.
- Educating children about the dangers of climbing on furniture to reach the television or its controls.



Safe installation

Use the belt fixing the television to facilitate restraining the television from toping forward.



1. **Read Instructions** - All the safety and operating instructions should be read before the appliance is operated.
2. **Retain Instructions** - The safety and operating instructions should be retained for future reference.
3. **Heed Warnings** - All warnings on the appliance and in the operating instructions should be adhered to.
4. **Follow Instructions** - All operating instructions should be followed.



5. **Water and Moisture** - The appliance should not be used near water.
6. **Cart and Stands** - The appliance should only be used with a cart or stand that is recommended by the manufacturer.
7. **Wall or Ceiling Mounting** - The appliance should be mounted to a wall or ceiling only as recommended by the manufacturer.
8. **Ventilation** - The appliance should be well situated so that its location or position does not interfere with its proper ventilation.
9. **Heat** - This appliance should be placed away from heat sources such as radiators, heat registers and stoves.
10. **Power Sources** - The appliance should only be connected to a power supply as described in the operating instructions or as marked on the appliance.
11. **Grounding or Polarization** - Precautions should be taken.
12. **Power Cord Protection** - Power supply cord should be routed so that it is not likely to be walked on, pinched by items placed upon it against the cord and its end.
13. **Cleaning** - The appliance should be cleaned only as recommended by the manufacturer.
14. **Power Line** - An outdoor antenna should be located away from power lines.
15. **Outdoor Antenna Grounding** - If an outside antenna is connected to the receiver, the antenna system must be grounded so as to provide against voltages and built-up static charges.
16. **Non-use Periods** - The power cord of the appliance should be unplugged from the outlet when left unused for a long period of time.
17. **Object and Liquid Entry** - Care should be taken so that objects did not fall, and liquids are not spilled into the enclosure through openings.
18. **Conditions requiring Service** - The appliance should be serviced by qualified service personnel when:
 - The power-supply cord or the plug has been damaged.
 - Objects have fallen on or liquid has been spilled into the appliance.
 - The appliance has been exposed to rain.
 - The appliance does not appear to operate normally or exhibits a marked change in performance.
19. The ventilation should not be impeded by covering the ventilation opening with items, such as newspapers, table-cloths,curtains,etc.
 No naked flame sources, such as lighted candles, should be placed on the apparatus.
 The apparatus shall be connected to mains socket outlet with a protective earthing connection.
 The appliance coupler regard as disconnection device, the disconnect device shall remain readily operable.

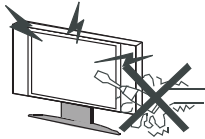

Warning

High voltages are used in the operating of this product. Do not remove the back cover of the cabinet. Refer servicing to qualified service personnel.

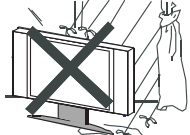

Warning

To prevent fire or electrical shock hazard, do not expose the main unit to rain or moisture.



Warning

Do not drop or push objects into television cabinet slots or openings. Never spill any kind of liquid on the television receiver.

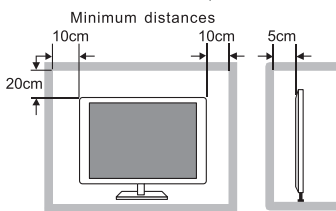

Caution

If the television is to be built into a compartment or similarly enclosed, the minimum distances must be maintained.

Heat built up can reduce the service life of your television, and can also be dangerous.



Caution

Never stand on, lean on, push suddenly the product or its stand.

You should pay special attention to children.

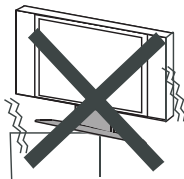

Caution

Do not place the main unit on an unstable cart stand, shelf or table.

Serious injury to an individual, and damage to the television, may result should it fall.

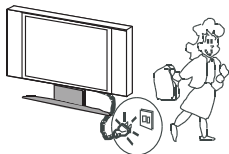

Caution

When the product is not used for an extended period of time, it is advisable to disconnect the AC power cord from the AC outlet.

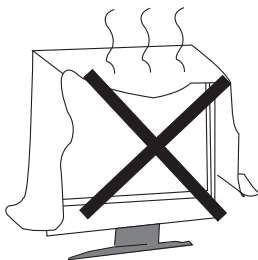

Caution

Avoid exposing the main unit to direct sunlight and other sources of heat. Do not position television receiver directly on other products which give off heat. E.g. Video cassette players, audio amplifiers. Do not block the ventilation holes in the back cover. Ventilation is essential to prevent electrical failure. Do not squash power supply cord under the main unit.



Caution

The panel used in this product is made of glass. It can break when the product is dropped or applied with force. Individuals should execute caution when dealing with broken glass should the panel break.



- Place the TV on a firm and flat surface, leaving a space of at least 10cm around the set and 30cm from the top of the set to the wall or cabinet. Ensure the TV is positioned close to the wall to avoid it falling when pushed.

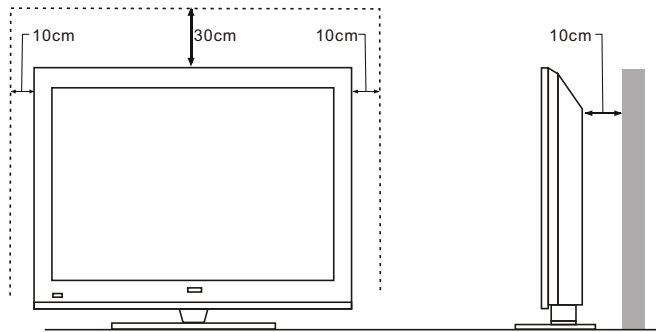

- When you turning the TV set, do not hold the top side of the TV set, you should hold the bottom side.

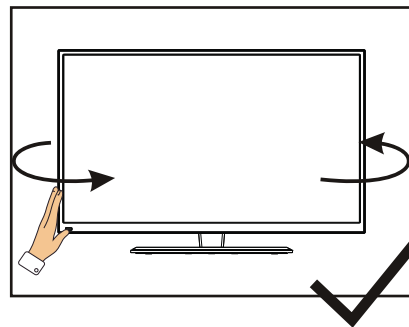
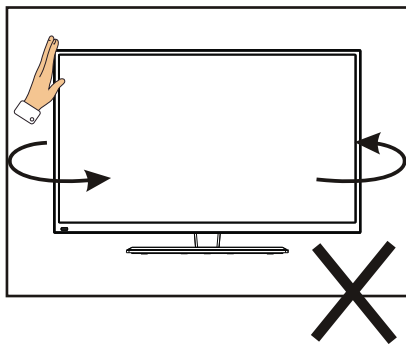

- When you lifting the TV set, do not use one hand to handle it, you should lift the TV set by two hands.

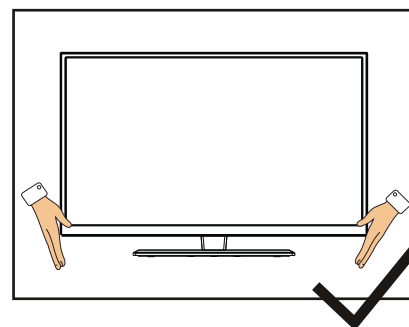
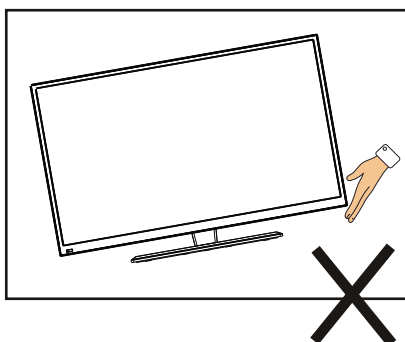

CONTENTS

1. Connection and Preparation of TV.....	2
1.1 Accessories	2
1.2 Installation of Stand.....	2
1.3 Keysand Interfaces.....	3
1.4 Remote Control.....	4
1.5 Installation of Batteries.....	5
2. Basic Operation.....	5
2.1 Power ON/OFF(Optional).....	5
2.2 Setting of Standby Mode.....	5
2.3 Home page	6
2.4 TV Setting	8
2.5 Hotel Mode	9
2.6 Media	13
3. Technical Specification.....	17
4. Supported Signal Modes.....	18
5. Simple Troubleshooting	19

1.Connection and Preparation of TV

1.1 Accessories

- ★ User Manual
- ★ Remote Control
- ★ Battery(UM-4/R03P/AAA)
- ★ Wall Mount Kit (Pre-assembled)(Optional)

1.2 Installation of Stand

(For the physical structure, please refer to the real object)

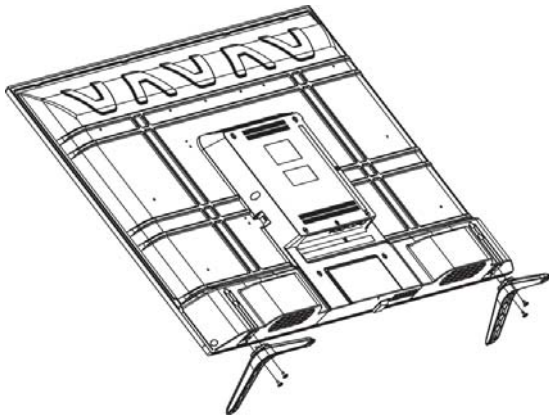

- ① Place the TV with the front panel facing downwards on the soft cloth or soft pads on a desk.
- ② Insert the stand into the bottom socket of the TV.
- ③ Insert the screws into the sockets and tighten them.

1.3 Keys and Interfaces

The design and specification takes actual products as the standard

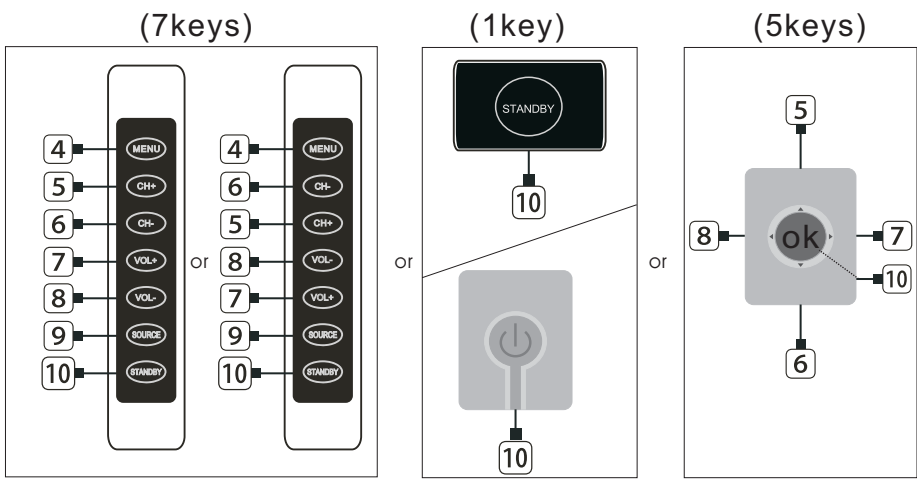
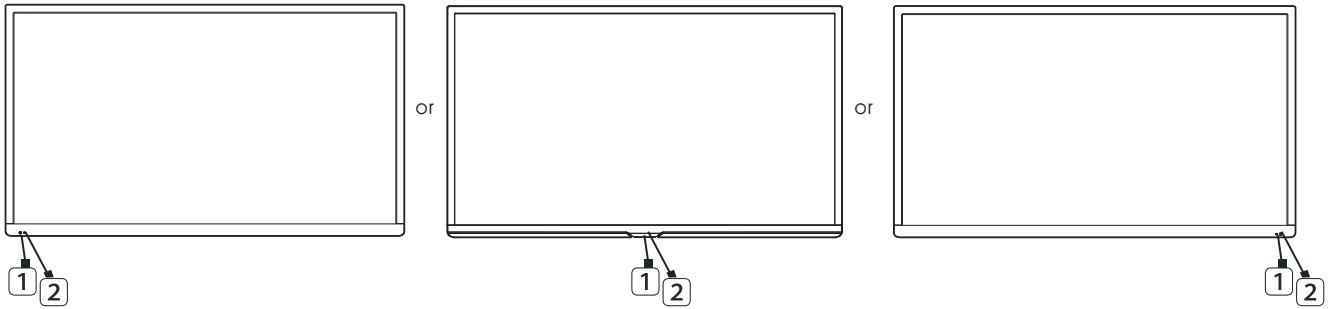

- 1. REMOTE SENSOR WINDOW
- 2. POWER INDICATOR
- 3. SPEAKER
- 4. MENU KEY
- 5. PROGRAM “+” KEY
- 6. PROGRAM “-” KEY
- 7. VOLUME “+” KEY
- 8. VOLUME “-” KEY
- 9. SOURCE KEY
- 10. STANDBYKEY
- 11. POWERPLUG INPUT

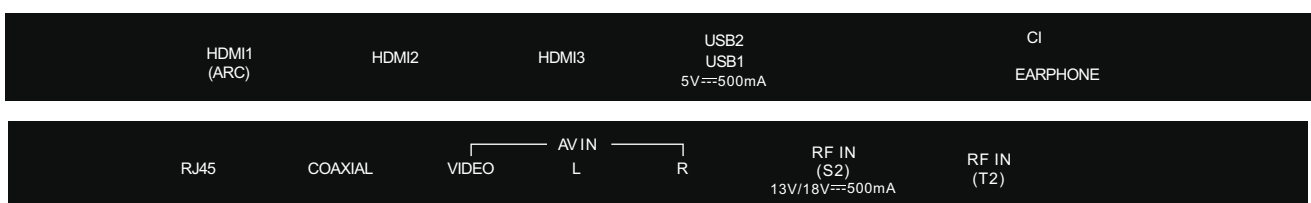
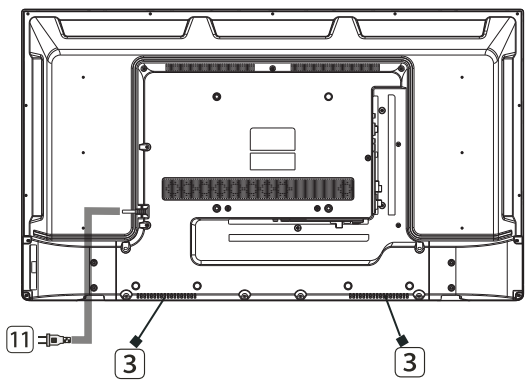

1.4 Remote Control

(Here is only the sketch, please in kind prevail)

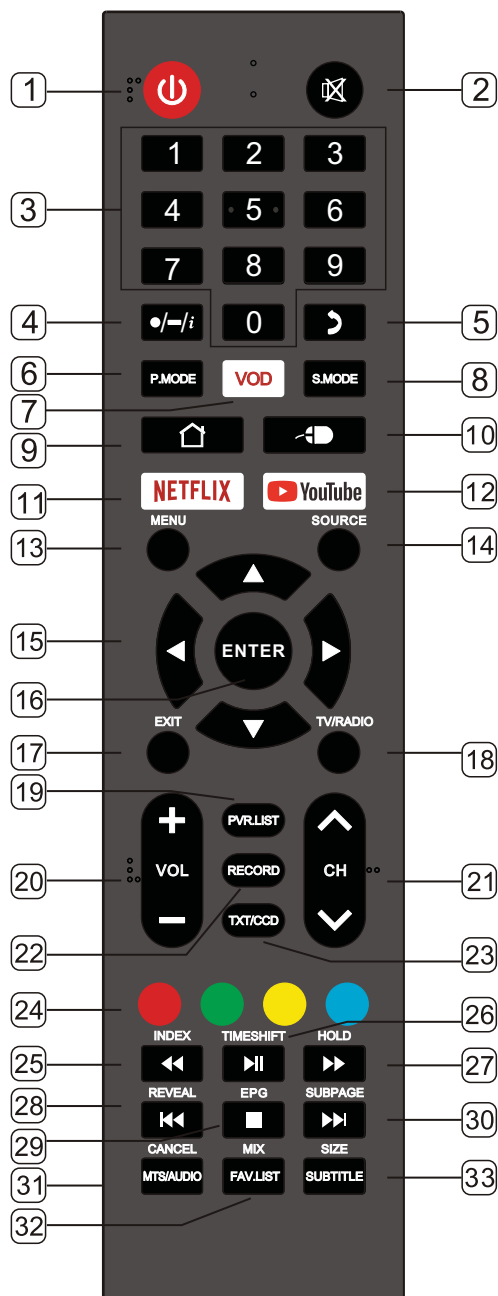

1. STANDBY(⏻) : Standby turn on and off.
2. MUTE: Mute sound.
3. 0~9 : Continue to press the keys to select a channel.
4. ●/~/i
 - : Press this button to enter a program number with different digits. eg. 10.1, 10.2.
 - ~/: Dot button and minor channel number.
 - i : Display the information of current video and audio.
5. RECALL: Return to previous channel.
6. P.MODE: Select the picture mode.
7. VOD: Open the VOD APP with shortcut key.
(Note: If the VOD APP is not pre-installed, this shortcut key is invalid)
8. S.MODE: Select the sound mode.
9. HOME: Enter to homepage.
10. MOUSE: Turn on the remote control mouse or turn it off.
11. NETFLIX: Enter Netflix APP.
12. YouTube: Enter YouTube APP.
13. MENU: Enter or exit menu.
14. SOURCE: Select the signal source.
15. ▲, ▼, ◀, ▶ Key: The menu item selection.
16. ENTER: Confirm or enter.
17. EXIT: Exit menu or operation.
18. TV/RADIO: Select the TV or Radio mode.
19. PVR.LIST: PVR list.
20. VOL+: Increase the volume.
21. VOL-: Decrease the volume.
22. CH▲ : Select the channel forward.
23. CH▼ : Select the channel backward.
24. RECORD: DTV mode record data USB disk.
25. TXT: Enter or exit teletext.
or CCD: Change the CCD mode.
26. RED: Access the red item or page.
GREEN: Access the green item or page.
YELLOW: Access the yellow item or page.
BLUE: Access the blue item or page.
27. INDEX: Display the index page.
MEDIA mode: ◀◀ Fast Backward.
28. TIMESHIFT: DTV mode time shift.
MEDIA mode: ▶▶ Press one time to pause, press again to playback.
29. HOLD: Hold the current page.
MEDIA mode: ▶▶ Fast Forward.
30. REVEAL: Reveal the hidden information.
MEDIA Mode: ◀◀ Previous.
31. EPG: Enter or exit EPG (Electronic Program .Guide).
MEDIA mode: ■ Stop the playback and return to file list.
32. SUBPAGE: Enter the sub page mode.
MEDIA mode: ▶▶ Next.
33. CANCEL (under TXT): cancel the TXT on screen.
MTS/AUDIO: MTS: Change the MTS mode.
or AUDIO: Select TV audio mode.
34. MIX (under TXT): setting transparency.
FAV.LIST: Favorite channel list.
35. SIZE (under TXT): setting sizes of the character.
SUBTITLE: DTV mode select subtitle mode.

1.5 Installation of Batteries

(Here is only the sketch, please in kind prevail)

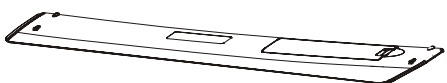
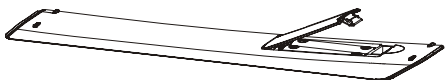
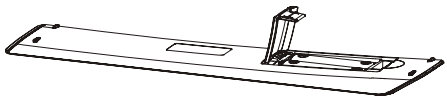

- ① Open the back lid of the remote control.
- ② Install two 7#(AAA)1.5V batteries.
Ensure the correct polarity of the batteries.
- ③ Cover the back lid.
Please take out of the batteries from the remote control for long time of no use.

If the remote control doesn't work properly, please carry out the following checks.

- Check the TV is turned on.
- Check the polarity of the batteries are correct.
- Check the batteries are not drained.
- Check the power supply is normal or the power cord is correctly connected.
- Check there are no special fluorescent light or neon light around.



2. Basic Operation

2.1 Power ON/OFF(Optional)

- Connect the power cord to the **AC input**. Insert the power cord into the appropriate socket.
- Press the **Power switch** to switch on the TV, then press **Power** button to turn on the unit.
- Press the **Power switch** again to switch off the TV.

Note: After switch off the TV, please don't immediately re-open the power switch, should be delayed one minute more to re-open the power switch.

2.2 Setting of Standby Mode

- Press () button to turn on the unit.
- Press () button again to return the display to standby mode. The power indicator turns red.
- Be sure not to set your TV in standby mode for a long period of time.

2.3 Home page

The following is the main menu interface. Press ▼/▲ to switch the navigation page.

Home

Press the <HOME> key to enter the Home page.

The content of this page includes: Source of TV programs, Cast, Media, Assistant, Settings and other category recommendations.

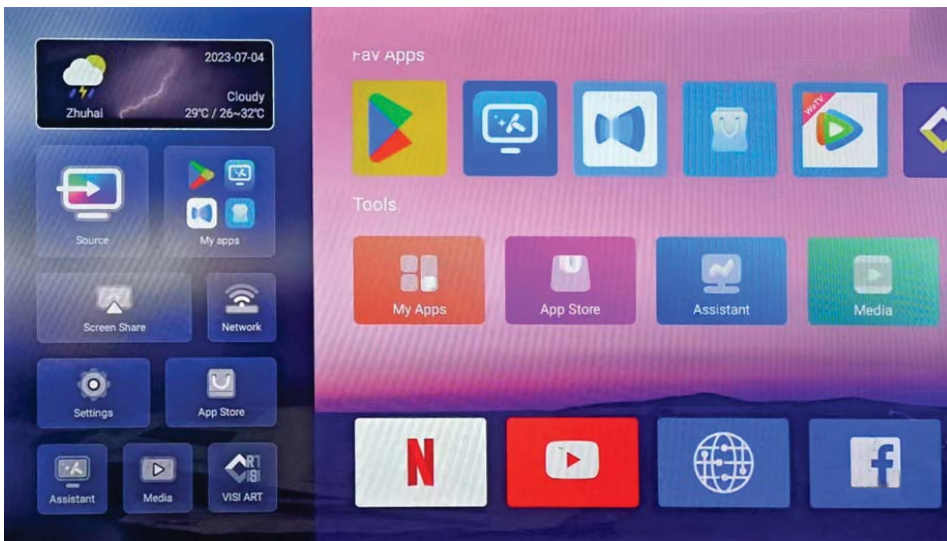

Settings

Press ▼/▲/◀/▶ to select Settings, and press < ENTER > to enter the Settings page for the next operation.

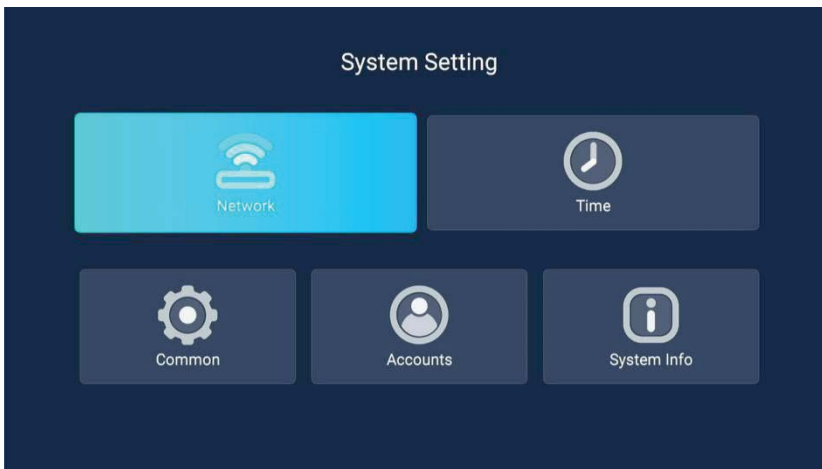

Note: Apps link and input source are subject to detail order, above photo just for your reference.

Network

On the Setting page, press ▼/▲◀/▶ to select Network, and then press<ENTER>to enter the Network page for the next operation.

Time

On the Setting page, press ▼/▲◀/▶ to select Time, and then press<ENTER >to enter the Time page for the next operation.

Common

On the Setting page, press ▼/▲◀/▶ to select Common, and then press<ENTER >to enter the Common page for the next operation.

Press ▼ / ▲ to select Language/Input Method/Wallpaper/System Recovery/The Device Name/Open source licenses/Third party licenses.

Language	Set the system language to English by default.
Input Method	Set input method.
Wallpaper	Set wallpaper.
System Recovery	Restore the system settings to the original state. password is [4711] .
The Device Name	Set Device Name.
Open source licenses	View open source licenses.
Third-party licenses	View third party licenses.

Accounts

On the Setting page, press ▼/▲◀/▶ to select Accounts, and then press<ENTER>to enter the Accounts page for the next operation.On this page, you can add an account or exit the current account.

System Info

On the Setting page, press ▼/▲◀/▶ to select System Info, and then press<ENTER>to enter the System Info page for the next operation.You can view system related information on this page.

Fav Apps

Press ▼/▲ to select Fav App.

You can view your personal software here and go to the application store to download your favorite software.

2.4 TV Setting

In the TV viewing interface, press the <Menu> button in the remote control to enter the TV setting menu.

Press the ◀/▶ key in the remote control to select. Press the <ENTER> key in the remote control to enter.

Source

Press the <Menu> key to enter the main menu interface, and press the ◀/▶ key to select the Source menu.

In this interface, you can press ▼/▲/◀/▶/<ENTER> to switch the signal source.

Picture

Press the <Menu> key to enter the main menu interface, and press the ◀/▶ key to select the Picture menu.

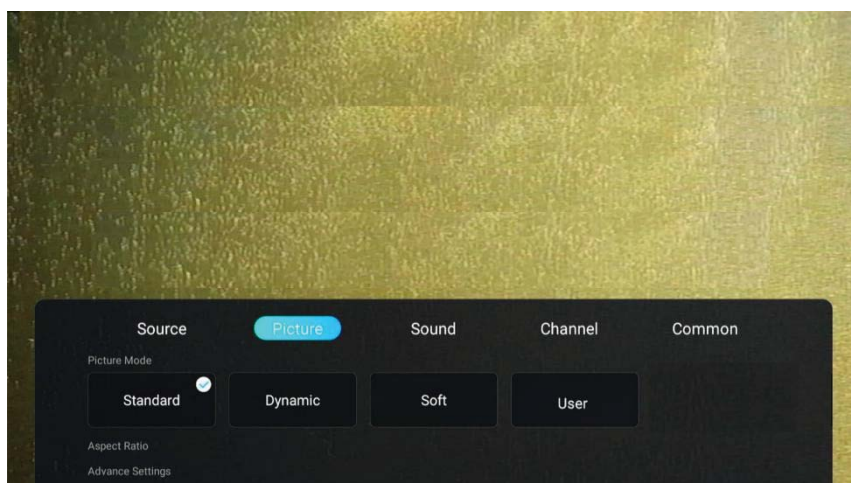

Picture Mode

Press ▼/▲ to select Picture Mode. Press ◀/▶ to select the image mode option.

Standard

Standard picture effect.

Dynamic

Enhance the contrast, chroma and sharpness of the picture, so that the picture is in dynamic color balance

-
- | | |
|------|--|
| Soft | Reduce the contrast, brightness, chroma and definition of the picture to make the picture look soft. |
| User | Select Custom Image Settings. |

Aspect Ratio

Press ▼/▲ to select Prospect Ratio. Press the ◀/▶ keys to select.

Advance Settings

Press ▼/▲ to select Advance Settings. Press the ◀/▶ keys to select.

Noise Reduction

Sets options for the intensity of image noise elimination.

Press the ◀/▶ key to select Noise Reduction, press the < ENTER >key to enter the selection page, and press the ◀/▶ key to select.

Color Temp

Adjust the overall color of the image.

Press the ◀/▶ key to select Color Temp, press the < ENTER >key to enter the selection page, and press the ◀/▶ key to select.

- | | |
|--------|---|
| Cool | The picture is green and blue, less red, and the overall color is light. The picture is more fresh and elegant. |
| Normal | The picture is not biased and the color is moderate. |
| Warm | The picture is red and green, less blue, and the color is more bright and soft. |

Backlight

Press the ◀/▶ key to select Backlight, press the < ENTER >key to enter the adjustment page, and press the ◀/▶ key to adjust.

DLC

Press the ◀/▶ keys to select DLC, press the < ENTER >key to enter the selection page, and press the ◀/▶ keys to select.

2.5 Hotel Mode

Press the **MENU** button, and then press "7906 " to the Hotel Setting.

Sound

Press the <Menu>key to enter the main menu interface, and press the ◀/▶ key to select the Sound menu.

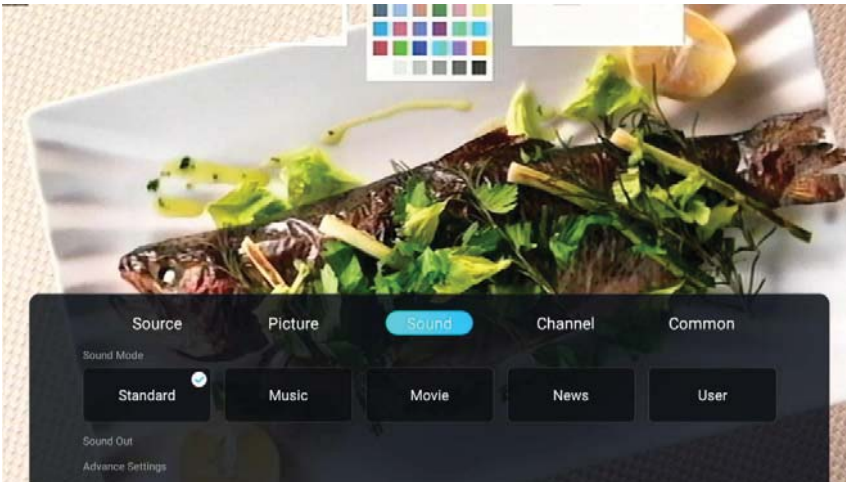

Sound mode

Press ▼/▲ to select Sound mode. Press ◀/▶ to select the sound mode option.

Standard	A balanced sound in any environment.
Music	The treble is strengthened and the bass is lowered.
Movie	Enhance the high and low pitch, rich in melody, and enhance the on-site effect.
News	Enhance voice.
User	Select Custom Sound Settings.

Sound Out

Press ▼/▲ to select Sound Out. Press ◀/▶ to select the audio output mode option.

Advance Settings

Press ▼/▲ to select advanced settings. Press the ◀/▶ keys to select.

Balance

Adjust various frequency components to compensate the defects of loudspeaker and sound field.

Press the ◀/▶ keys to select Balance, press the < ENTER > key to enter, and press the ◀/▶ keys to adjust.

AVC

Press the ◀/▶ keys to select AVC, and press the < ENTER > key to switch on/off.

After the "Automatic Volume Control" is turned on, once the volume is set, it can keep the volume in the speaker stable no matter what the TV sound of each channel is different.

Hearing Impaired

Press ◀/▶ button to select Hearing Impaired. and then press the < ENTER > key to enter.

Audio Description

Press ◀/▶ button to select Audio description. and then press the < ENTER > key to enter.

AD Volume

Press ◀/▶ button to select AD Volume. Press the < ENTER > button to select.

Digital Audio Output

Press the ◀/▶ keys to select Digital Audio Output, which is Off by default.

Audio Language

Press ◀/▶ to select Audio Language , and press the < ENTER > button to select .

SPDIF Delay

Press the ◀/▶ keys to select SPDIF Delay, which is 0 by default.

Surround

The direction of each sound source in the original signal is reproduced to make the user feel surrounded by sounds from different directions.

Press the ◀/▶ keys to select Surround, and press the < ENTER >key to switch on/off.

Audio Only

Press the ◀/▶ key to select Audio Only, and press the < ENTER >key to switch on/off.

Channel

Press the <Menu>key to enter the main menu interface, and press the ◀/▶ key to select the Channel menu.

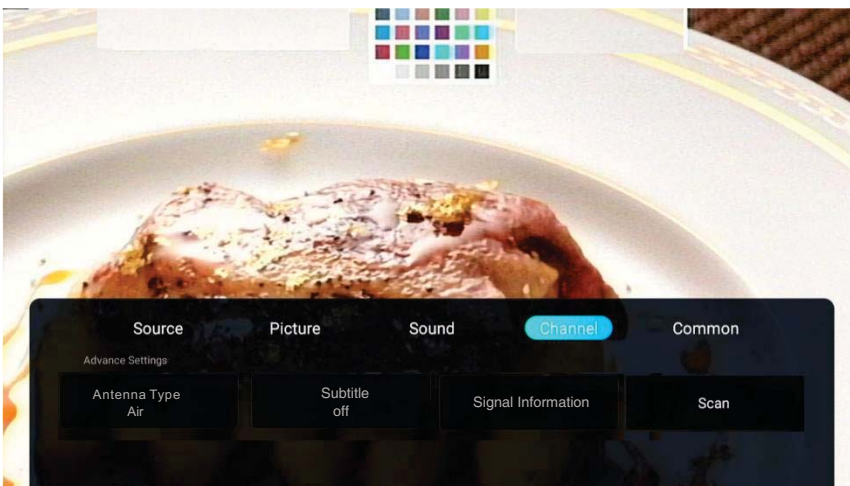

Antenna Type

Press ◀/▶ button to select Antenna Type. press the < ENTER > key to enterselect .

Subtitle

Press ◀/▶ to select Subtitle , and then press the < ENTER > key to enter.

Signal Information

Press ◀/▶ button to select Signal Information .Press ENTER ◀/ ▶ button to select view.

Scan

Press the ◀/▶ keys to select Scan, and then press the < ENTER >key to enter.

Press ▼/▲ to select.

Channel List

View all existing program channels. Press ▼/▲ to select Channel List, and press▶to enter the submenu.

EPG

Press ◀/▶ to select EPG , and then press the < ENTER > key to enter.

CI Card

Press ◀/▶ button to select CI Card to view and set the the information of CI card.

Common

Press the <Menu> key to enter the main menu interface, and press the ◀/▶ key to select the Common menu.

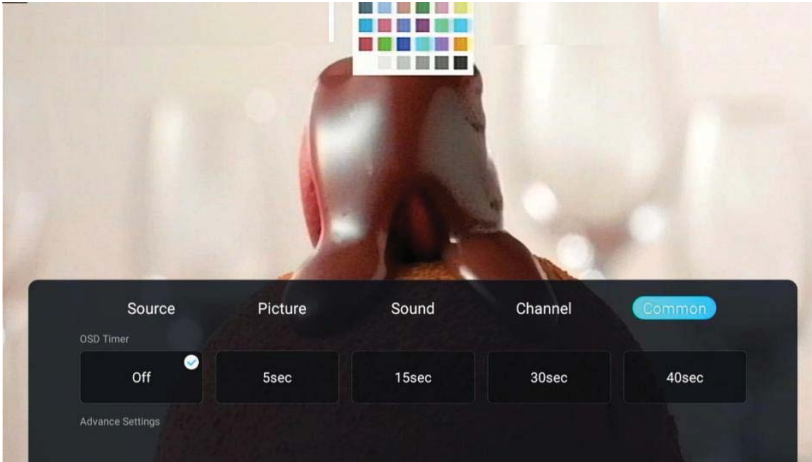

OSD Timer Press ▼/▲ to select OSD Timer, and press ◀/▶ to select.

Advance Settings Press ▼/▲ to select Advance Settings.

Sleep Timer

Press the ◀/▶ key to select the Sleep Timer, press the <ENTER> key to enter, and press the ◀/▶ key to select.

On Timer Press ◀ / ▶ button to select On Timer. Press ◀ / ▶ button to select.

Off Timer Press ◀ / ▶ button to select Off Timer. Press ◀ / ▶ button to select.

Auto Standby Timer

Press the ◀/▶ key to select the Auto Standby Timer, press the <ENTER> key to enter.

Daylight Saving

Press ◀/▶ to select the Daylight Saving, press the < ENTER > key to enter.

Blue Screen

When there is no signal, the screen will display blue.

Press the ◀/▶ key to select the Blue screen, and press the < ENTER > key to select on/off.

ECO Mode

Press the ◀/▶ key to select ECO Mode, and press the <ENTER > key to select On/Off.

Teletext Press ▼ /▲ button to select Teletext. Press ◀ / ▶ button to select.

Audio Language 1st

Press ◀ / ▶ button to select Audio Language 1st. Press ENTER & ◀ / ▶ button to select audio language.

Audio Language 2nd

Press ◀ / ▶ button to select Audio Language 2nd. Press ENTER & ◀ / ▶ button to select audio language.

CEC

Press the ◀/▶ key to select CEC, and press the < ENTER > key to enter the submenu.

Press the ◀/▶/<ENTER> key in the submenu to turn on or off the functions.

Lock

Press the ◀/▶ key to select Lock, press the < ENTER > key to enter. **password is [4711]** .

PVR Setting Press ▼ / ▲ button to select PVR Setting. Press ▼ / ▲ button to select Select.

Menu Reset

Restore default settings.

Press the ◀/▶ keys to select Menu Reset, and press the <ENTER> key to select whether to reset.

2.6 Media

After inserting the USB device, the system will pop up to prompt you whether to enter the multimedia page. Select ENTER to enter.

If there is no such page, you can press the ▼/▲/◀/▶ keys to select Media, and then press the < ENTER > key to enter the Media page for the next operation.

After entering, the page is displayed as follows.

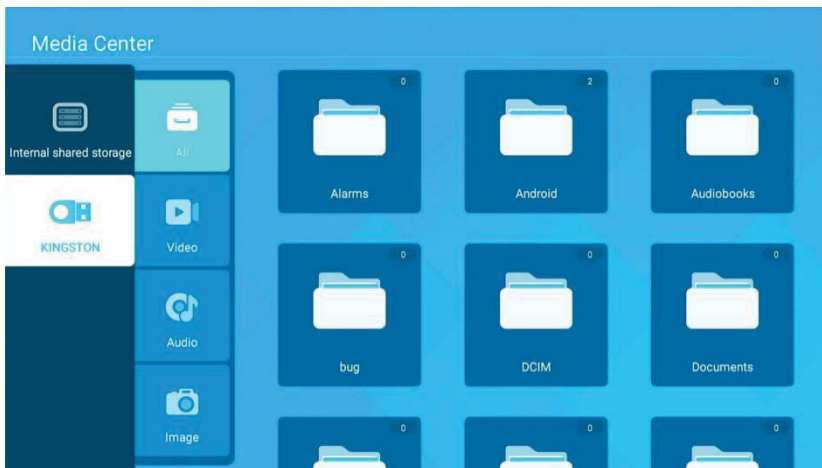

Video

Press ▼/▲ to select the video, and then press ▼/▲/◀/▶ to select the video you want to play.

Press the <MENU> key to display the left menu page.

List

Press the <Menu> key to enter the lower menu page, and press ◀/▶ to select the List. This page shows all available videos.

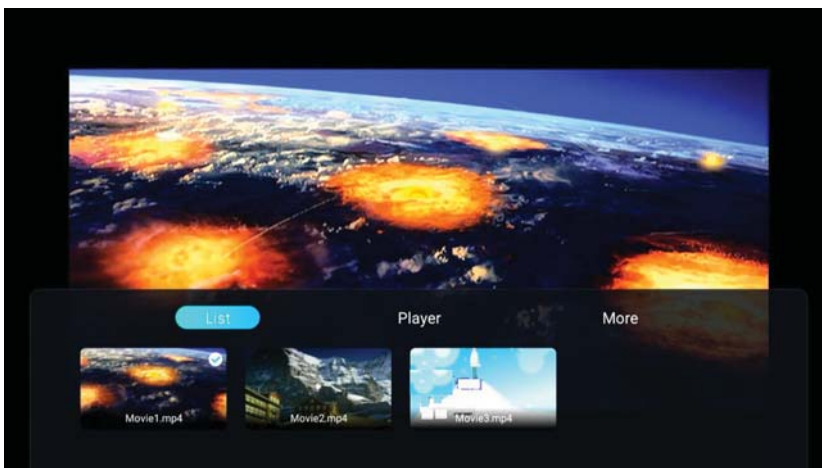

Player

Press the <Menu> key to enter the lower menu page, and press ◀/▶ to select the Player.

Play Mode

Press ▼/▲ to select Play Mode, and then press ◀/▶ to select.

Aspect Ratio

Press ▼/▲ to select Aspect Ratio, and then press ◀/▶ to select.

Advance Settings

Press ▼/▲ to select Advance Settings, and then press ◀/▶ to select.

Audio Track

Press ◀/▶ to select Audio Track, and then press <ENTER > to select.

Subtitle Track

Press ◀/▶ to select Subtitle Track, and then press <ENTER > to select.

Region Language

Press ◀/▶ to select Region Language, and then press <ENTER> to display all Region Languages.

External Subtitle

Press ◀/▶ to select an External subtitle, and then press <ENTER > to select the external subtitle you want to add.

Progress Jump

Press ◀/▶ to select Progress Jump, and then press < ENTER > to select.

Toggle list display

Press ◀/▶ to select Toggle list display, and press the < ENTER >key to switch on/off.

Information

Press ◀/▶ to select Information, and then press <ENTER > to display the specific information of the current video.

More

Press the <Menu> key to enter the lower menu page, and press ◀/▶ to select the More.

Press ▼/◀/▶/<ENTER > to select Image Settings or Sound Settings.

Image Settings

Press ▼/▲/▶ to select Image Settings, and press < ENTER > to enter the corresponding setting page.

Sound Settings

Press ▼/▲/▶ to select Sound Settings, and press < ENTER> to enter the corresponding setting page.

Audio

Press ▼/▲ to select the Audio, and then press ▼/▲/◀/▶ to select the audio you want to play.

Press the <MENU> key to display the lower menu page.

List

Press the <Menu> key to enter the lower menu page, and press ◀/▶ to select the List. This page shows all available audios.



Player

Press the <Menu> key to enter the lower menu page, and press ◀/▶ to select the Player.

Play Mode

Press ▼/▲ to select Play Mode, and then press ◀/▶ to select.

Advance Settings

Press ▼/▲ to select Advance Settings, and then press ◀/▶ to select.

Progress Jump

Press ◀/▶ to select Progress Jump, and then press < ENTER > to select.

Toggle list display

Press ◀/▶ to select Toggle list display, and press the < ENTER > key to switch on/off.

Information

Press ◀/▶ to select Information, and then press < ENTER > to display the specific information of the current audio.

More

Press the <Menu> key to enter the lower menu page, and press ◀/▶ to select the More.

Press ▼/◀/▶/< ENTER > to select Image Settings or Sound Settings.

Image Settings

Press ▼/▲/▶ to select Image Settings, and press < ENTER > to enter the corresponding setting page.

Sound Settings

Press ▼/▲/▶ to select Sound Settings, and press < ENTER > to enter the corresponding setting page.

Image

Press ▼/▲ to select the Image, and then press ▼/▲/◀/▶ to select the image you want to play. Press the <MENU> key to display the lower menu page.

List

Press the <Menu> key to enter the lower menu page, and press ◀/▶ to select the List. This page shows all available images.

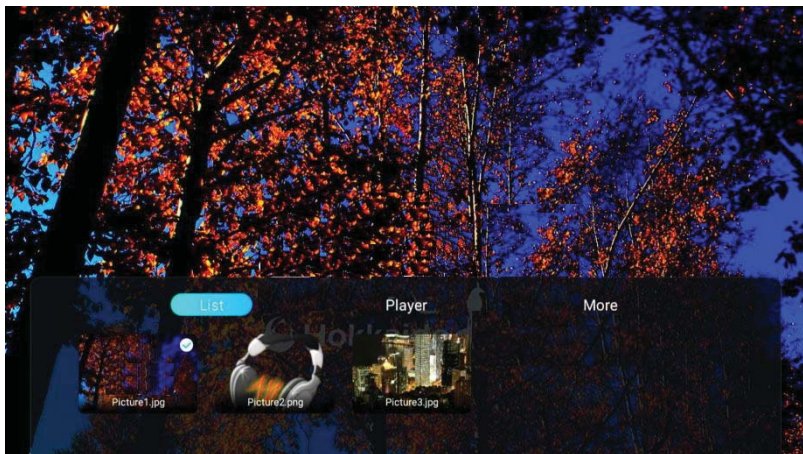

Player

Press the <Menu> key to enter the lower menu page, and press ◀/▶ to select the Player.

Aspect Ratio

Press ▼/▲ to select Aspect Ratio, and then press ◀/▶ to select.

Rotate

Press ▼/▲ to select Rotate, and then press ◀/▶ to select.

Advance Settings

Press ▼/▲ to select Advance Settings, and then press ◀/▶ to select.

Play Slide

Press ◀/▶ to select Play Slide, and then press < ENTER > to display all pictures.

Interval Time

Press ◀/▶ to select Interval Time, and press < ENTER > to enter the corresponding setting page.

Toggle list display

Press ◀/▶ to select Toggle list display, and press the < ENTER > key to switch on/off.

Information

Press ◀/▶ to select Information, and then press < ENTER > to display the specific information of the current image.

More

Press the <Menu> key to enter the lower menu page, and press ◀/▶ to select the More.

Image Settings

Press ▼/▲/▶ to select Image Settings, and press < ENTER > to enter the corresponding setting page.

Sound Settings

Press ▼/▲/▶ to select Sound Settings, and press < ENTER > to enter the corresponding setting page.

3. Technical Specification

Product Model	42AOS450E	
Screen Size	42" diagonal	
Aspect Ratio	16:9	
Power Supply	AC 100-240V~,50/60Hz	
Power Consumption	75W	
TV System	PAL B/G D/K I,SECAM B/G D/K DVB-T/T2/C/S/S2(s/s2 option) (There is no DVB-C signal in some Countries or Areas.)	
Audio Output Power (Internal)	8Wx2	
Input Terminal	Antenna Input	x 2 (S2 option)
	USB Input	x 2
	HDMI Input	x 3
	VGA Input	NO
	PC AUDIO Input	NO
	Audio Input (L/R)	x 1
	Video Input	x 1
	YPbPr Input	NO
	RJ45 Input	x 1
	CI card In	x 1
	SCART In/Output	NO
	DC In (12V)	NO
	CARD SLOT	NO
Output Terminal	Earphone	x 1
	Audio Line Out(L/R)	NO
	Video Output	NO
	Optical	NO
	Coaxial out	x 1
Working Temperature	0°C~40°C	
Working Humidity	20% ~ 80% Non-condensing	

Note:the specification shown above may change without notice for quality improvement.

LED COLOR TV

4. Supported Signal Modes

A.HDMI Mode

Resolution	Horizontal Frequency (Khz)	Vertical Frequency (Hz)
480p	31.468	59.94
576p	31.25	50.00
720p	45.00	60.00
1080i	33.75	60.00
1080p(1920x1080)	67.50	60.00

-When the signal received by the Display exceeds the allowed range, a warning message will appear on the screen.

-You can confirm the input signal format onscreen.

LED COLOR TV

5. Simple Troubleshooting

If the display fails or the performance changes dramatically, check the display in accordance with the following instructions. Remember to check the peripherals to pinpoint the source of the failure.

Symptom	Solution
Power cannot be turned on.(Power indicator does not light.)	-Check that both ends of the power cable are plugged into the socket appropriately and the wall socket is operational
No Input Signal message appears.	-Check that the signal line is connected properly. -Check that the power of the relevant peripherals is turned on. -Check that the Input option that has been selected matches with the input signal.
The remote control does not function properly.	-Check the batteries are not drained.(Use new batteries.) -Check that the remote control is within the operating range. -Check that the remote control is pointed to the remote control window on the display. -Check that there are no obstacles between the remote control and the remote control window.
Flashing spots or stripes appear on the screen.	-Check that there are no emission (Car, HV cable or Neon lamp) or other possible interference sources.
Image colour or quality deteriorates.	-Check that all the video settings are adjusted appropriately, such as brightness, contrast, colour etc. -For more information about video settings, refer to OSD Functions in Chapter 2.
Screen position and size are incorrect.	-Check that the screen position and size is adjusted appropriately.
Image or colour is incorrect.	-Check that the signal line is connected properly. -When connecting to a PC, you can change the resolution of the PC to acquire the correct image. The discrepancy of the PC output signal may affect the display of the image.
Display warning message.	-Check that the input signal line is properly fixed. -Select the correct input signal. -For more information, refer to Supported Signal Modes in Chapter 4.



Nadamo se da ste pažljivo pročitali uputstva i da ćete ih se pridržavati. Za više informacija o FOX uređajima posetite našu internet stranicu:

www.foxelectronics.rs