



UPUTSTVO ZA UPOTREBU

LED TELEVIZORI

Model: 32AOS430E

HDMI

Hvala Vam što ste kupili ovaj uređaj.

FOX LED televizori prepoznaju se po odličnim tehničkim karakteristikama, kao i modernom, funkcionalnom i elegantnom dizajnu. Osim toga konstantna unapređenja u vidu postprodajne

podrške, izuzetno efikasna i rasprostranjena servisna mreža čine da se ponosni vlasnici FOX televizora mogu osećati sigurno.

Napravili ste pravi izbor.



U nastavku slede uputstva za upotrebu. Nisu komplikovana, ali ih se morate pridržavati.

SR

VAŽNA BEZBEDONOSNA UPUTSTVA

UPOZORENJE

KAKO BISTE SPREČILI POŽAR ILI ELEKTRIČNI UDAR NEMOJTE KORISTITI PRODUŽNI KABL, DUPLI UTIKAČ ILI DRUGE DODATKE NA UTIČNICI OSIM ONIH KOJI BI MOGLI DA SPREČE IZAZIVANJE STRUJNOG UDARA. KAKO BISTE SPREČILI POŽAR ILI ELEKTRIČNI UDAR NE IZLAŽITE OVAJ UREĐAJ VLAZI ILI KIŠI.

 <p>Ovaj simbol munje u jednakostraničnom trouglu upozorava korisnike na prisustvo opasnog i ne izolovanog napona unutar kućišta proizvoda koji može biti dovoljan da stvori rizik STRUJNOG UDARA</p>	<p>CAUTION</p> <p>RISK OF ELECTRIC SHOCK DO NOT OPEN</p> <p>Upozorenje: Da biste smanjili rizik od strujnog udara nemojte skidati poklopac (ili zadnju stranu). Unutra nema delova koje korisnik može sam da zameni. Za obavljanje servisa zatražite pomoć kvalifikovanog osoblja.</p>	 <p>Znak uzvika unutar jednakostraničnog trougla u ovom uputstvu upozorava korisnika na prisustvo važnih instrukcija za rad i održavanje (servisiranje) uređaja.</p>
--	---	---

Ovaj aparat ne treba izlagati vodi, a predmete ispunjene tečnošću poput vaza ne treba da budu postavljeni na i oko uređaja.

OPREZ

Postoji opasnost od eksplozije ako se baterija nepropisno zameni.

Zamenite postojeću sa samo odgovarajućom vrstom baterije.

Nemojte izlagati bateriju direktnoj sunčevoj svetlosti ili bilo kojem drugom izvoru toplote.

Obezbedite pravilno odlaganje istrošenih baterija.

Ostavite lako dostupnim mesto gde je utikač ili nastavak za prekid napajanja.

Da biste smanjili rizik od strujnog udara, ne obavljajte bilo kakvo servisiranje osim onih koje se pominju u ovom uputstvu.

VAŽNE INFORMACIJE

Ako televizor nije postavljen na dovoljno stabilnom mestu, može postojati potencijalna opasnost od pada.

Mnoge povrede, posebno dečije, mogu se izbeći primenom jednostavnih mera opreza kao što su:

Korišćenje elemenata ili stalaka koje je preporučio proizvođač televizora.

Korišćenje samo onog nameštaja koji može sigurno izdržati uređaj.

Obezbeđivanje uređaja tako da ne prelazi ivicu nameštaja.

Nemojte postavljati TV na visok nameštaj (na primer, ormare ili police) bez prethodnog pričvršćivanja kako nameštaja tako i uređaja na odgovarajuću površinu.

Ne pokrivajte televizor krpom i ne stavljajte drugi materijal između televizora i nameštaja na kom on stoji.



Sigurna instalacija

Koristite pojas za fiksiranje televizora kako bi sprečili uređaj od pada unapred.



1. **Pročitajte uputstva**- Sve napomene o sigurnosti i načinu rada treba pročitati pre uključivanja aparata.
2. **Sačuvajte uputstva** – Uputstva za sigurnost i uputstvo za upotrebu treba da se sačuvaju za buduće potrebe.
3. **Imajte u vidu Upozorenja** – Treba se pridržavati svih upozorenja na aparatu i svih uputstava za upotrebu.
4. **Pratite uputstva**- Treba pratiti sva uputstva.



5. **Voda i vlažnost** – Aparat ne treba koristiti u blizini vode.
6. **Nosač i postolje** – Aparat treba koristiti samo sa nosačem ili postoljem koje preporučuje proizvođač
7. **Montaža na zid ili plafon** – Aparat treba da se montira na zid ili plafon samo po preporuci proizvođača.
8. **Ventilacija** – Aparat treba da bude dobro postavljen, tako da lokacija ili pozicija aparata ne ometaju njegovo provetravanje.
9. **Toplota** – Ovaj aparat treba postaviti dalje od izvora toplote kao što su radijatori i peći.
10. **Napajanje** - Aparat treba povezati samo na napajanje kao što je opisano u uputstvima za upotrebu ili onako kako je naznačeno na uređaju.
11. **Uzemljenje ili polarizacija** – Treba preduzeti mere predostrožnosti.
12. **Zaštita kabla za napajanje** – Naponski kabl treba da bude usmeren tako da je malo verovatno da se može gaziti, priklješiti stvarima na njemu i njegovom kraju.
13. **Čišćenje** – Aparat bi trebalo čistiti samo po preporuci proizvođača.
14. Napajanje spoljne antene treba da se nalazi daleko od dalekovoda.
15. **Uzemljenje spoljne antene** – Ako je spoljna antena povezana na prijemnik, antenski sistem mora biti uzemljen kako bi se obezbedila zaštita od naponskog i izvornog statičkog elektriciteta.
16. **Kada ga dugo ne koristite** – napajanje uređaja trebalo bi da bude isključeno iz utičnice kada se ne koristi duži vremenski period.
17. **Upad predmeta i tečnosti** – Treba paziti da predmeti ne upadnu, a tečnost ne prospe u kućište kroz otvore.
18. **Kada je potreban servis** – Aparat treba da servisira kvalifikovano servisno osoblje kada su:
 - Kabal za struju ili utikač oštećeni.
 - Kada predmeti upadnu ili kada se tečnost prolije po uređaju
 - Kada je aparat izložen kiši
 - Kada aparat ne radi normalno ili pokazuje značajnu promenu u radu.
19. Ventilacioni otvori ne bi trebalo da budu pokriveni predmetima, kao sto su novine, tkanine, zavese itd.
20. Izvore otvorenog plamena, kao sto su upaljene sveće, ne bi trebalo da stoje na aparatu
21. Aparat će biti povezan sa mrežnom utičnicom sa zaštitnim uzemljenjem. Utičnica ili nastavak za prekid napajanja trebaju da budu lako dostupni.

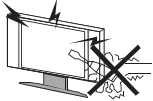

UPOZORENJE

Visok napon se koristi u napajanju ovog uređaja. Ne uklanjajte zadnji poklopac. Obratite se kvalifikovanoj osobi za obavljanje servisa.

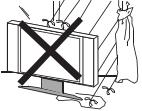

UPOZORENJE

Da biste sprečili požar ili strujni udar, nemojte izlagati uređaj kiši ili vlazi.



UPOZORENJE

Nemojte ispuštati i gurati predmete u kućište TV-a ili u otvore. Nikada nemojte prosipati tečnost na TV prijemnik.

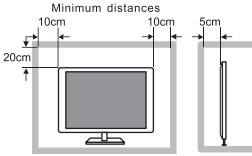

OPREZ

Ako televizor treba da se ugradi u zatvoreni odeljak ili na sličan način, morate se pridržavati dela uputstva o minimalnim udaljenostima. Toplota može smanjiti životni vek televizora, a takođe može biti povećan rizik od požara.



OPREZ

Nikada nemojte da stanete ili se oslonite ili gurnete uređaj ili stalak na kom se uređaj nalazi. Treba obratiti posebnu pažnju na decu.

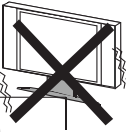

OPREZ

Ne stavljajte glavnu jedinicu na nestabilno postolje, policu ili sto. Usled pada može doći do ozbiljne povrede lica ili štete na televizoru.



OPREZ

Kada se proizvod ne koristi duži vremenski period, preporučljivo je da isključite mrežni kabl iz utičnice .

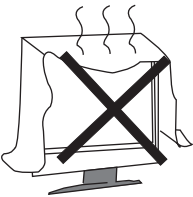

OPREZ

Izbegavajte izlaganje glavne jedinice direktnom suncu i drugim izvorima toplote. Ne postavljajte televizor na druge proizvode koji emituju toplotu. Na primer: Video uređaj, audio pojačala. Ne blokiraj otvore za ventilaciju u zadnjem poklopcu. Ventilacija je od suštinskog značaja za sprečavanje električnih kvarova. Ne stavljajte kabl za napajanje ispod glavne jedinice.



OPREZ

Panel (ekran) koji se koristi u ovom proizvodu napravljen je od stakla. Može se slomiti padom uređaja ili nasilnim udarcem. Pojedinci treba oprezno da rade sa razbijenim staklom ekrana.



- Postavite TV na stabilnu, ravnu površinu, ostavljajući najmanje 10 cm oko njega i 30 cm između vrha seta i zida ili ormarića. Da biste sprečili da se televizor prevrne kada ga gurnete, postavite ga blizu zida. Umesto da držite gornju stranu televizora kada ga okrećete, trebalo bi da držite donju stranu.

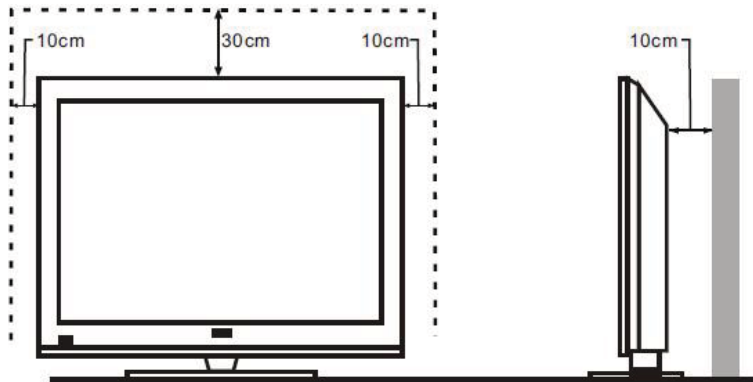

- Izbegavajte rukovanje televizorom samo jednom rukom kada ga podižete; umesto toga, koristite dve ruke.

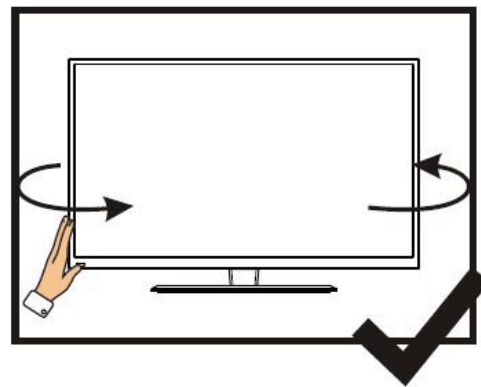
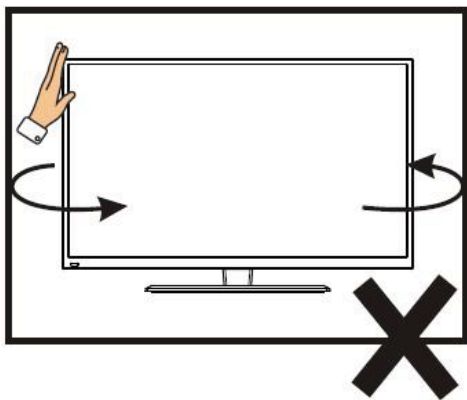

- Izbegavajte rukovanje televizorom samo jednom rukom kada ga podižete; umesto toga, koristite dve ruke.

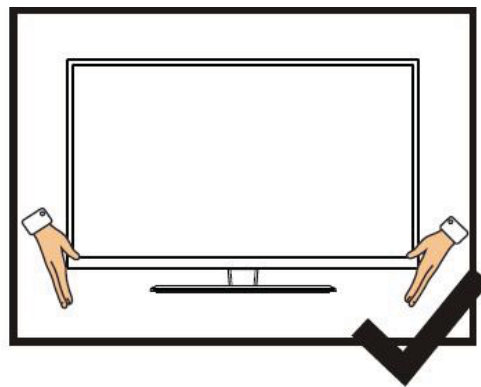
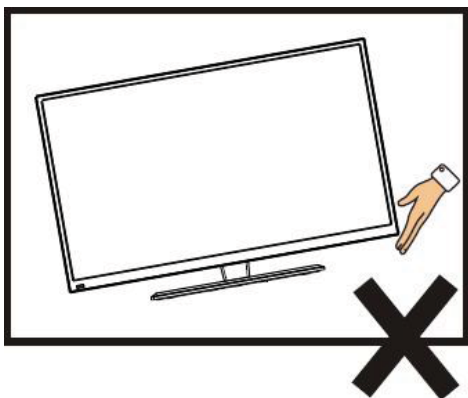

SADRŽAJ

1. Priključivanje i priprema TV-a	2
1.1 Dodatna oprema	2
1.2 Instalacija postolja	2
1.3 Tasteri i interfejsi	3
1.4 Daljinsko upravljanje	4
1.5 Instalacija baterija	5
2. Osnovna operacija	5
2.1 Uključivanje/isključivanje (opciono)	5
2.2 Podešavanje režima pripravnosti	5
3. ULAZNI IZVOR	6
4. Glavni Meni	6
5. Početna stranica	13
5.1 POČETNA	13
5.2 Podešavanje	13
5.3 Mediji	15
6. Hotel Mode	17
7. Tehnička specifikacija	18
8. Podržani režimi signala	19
9. Jednostavno otklanjanje poteškoća	20

FOX LED TV

1 Priključivanje i priprema TV-a

1.1 Dodatna oprema

- ✧ Uputstvo za korišćenje
- ✧ Daljinsko upravljanje
- ✧ Baterija (UM-4/R03P/AAA)
- ✧ Komplet za montiranje na zid (unapred montiran) (opciono)

1.2 Instalacija postolja

(Molimo pogledajte stvarni objekat za detalje o fizičkoj strukturi.)

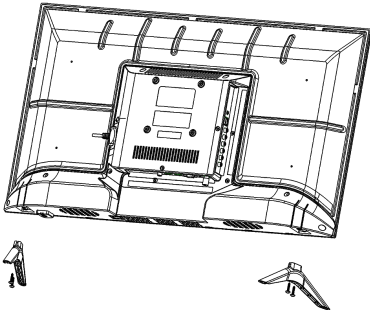

- 1) Postavite TV na mekanu tkaninu ili meke jastuke na sto tako da prednja ploča bude okrenuta nadole.
- 2) Stavite postolje u donju utičnicu televizora.
- 3) Zašrafite utičnice sa zavrtanjima na mestu, a zatim ih zategnite.

FOX LED TV

1.3 Tasteri i interfejsi

Stvarne stavke se koriste kao standard u dizajnu i specifikaciji.

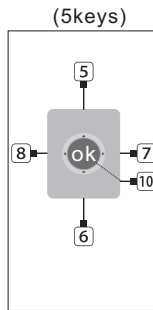
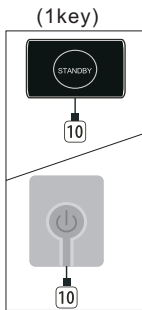
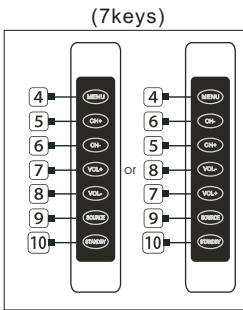
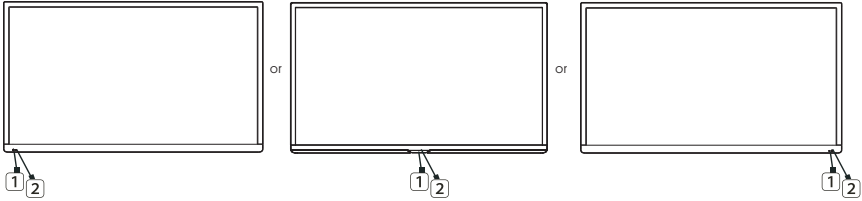

- 1 PROZOR DALJINSKOG SENZORA
- 2 INDIKATOR SNAGE
- 3 GOVORNIK
- 4 MENU DUGME
- 5 PROGRAM "+" DUGME
- 6 PROGRAM "-" DUGME
- 7 VOLUME "+" DUGME
- 8 VOLUME "-" DUGME
- 9 SOURCE DUGME
- 10 TASTER PRIPRAVNOSTI
- 11 ULAZ ZA NAPAJANJE

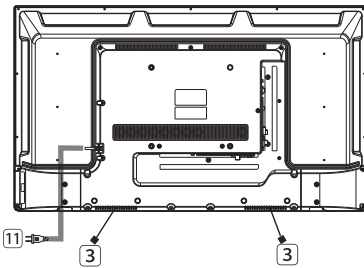

HDMI2 (ARC)	HDMI3	USB1 5V---500mA	USB2 5V---500mA	CI			
VIDEO	AV IN L R	RF IN (T2)	RF IN (S2) 13V/18V---500mA	EARPHONE	RJ45	COAXIAL	HDMI1

FOX LED TV

1.4 Daljinski upravljač

(Ovde je samo skica, molimo Vas pregledajte)

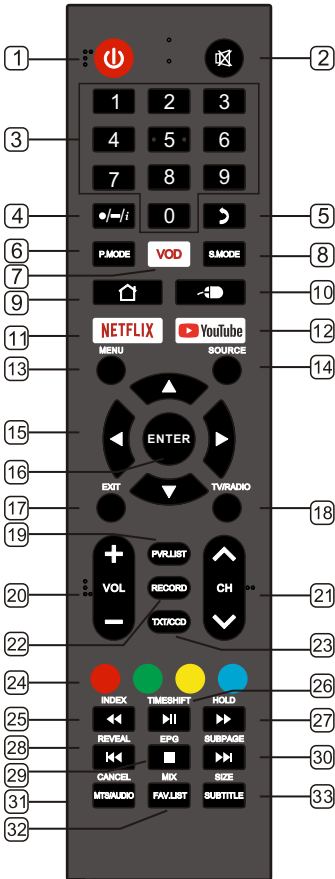

1. STANDBY(⏻): Stanje pripravnosti uključeno i isključeno
2. MUTE: Isključite zvuk
3. 0-9: Nastavite pritiskati tastere za odabir kanala.
4. ●/±/i:
 - : Pritisnite ovo dugme za ulazak u broj programa s različitim ciframa. npr. 10.1, 10.2.
 - ±: Dugme s tačkom i manji broj kanala.
 - i: Prikažite informacije trenutnog video i audio zapisa.
5. RECALL: Povratak na prethodni kanal.
6. P.MODE: Odaberite način slike
7. VOD: Otvorite aplikaciju VOD s tipkom s kraticom.
(Napomena: Ako aplikacija VOD nije unapred postavljena, ova tipka kratice je nevažeća)
8. S.MODE: Odaberite način zvuka.
9. HOME: Uđite u početnu stranicu.
10. MOUSE: Uključite ili isključite miš s daljinskim upravljačem.
11. NETFLIX: Uđite u aplikaciju Netflix.
12. YouTube: Uđite u aplikaciju YouTube.
13. MENU: Uđite u meni ili izađite iz njega.
14. SOURCE: Odaberite izvor signala.
15. ▲,▼,◀,▶ key: Odabir stavke menija.
16. ENTER: Potvrdite ili uđite.
17. EXIT: Izađite iz menija ili radnje.
18. TV/RADIO: Odaberite TV ili način radija.
19. PVR.LIST: PVR lista.
20. VOL+: Povećajte jačinu.
VOL-: Smanjite jačinu.
21. CH+: Odaberite kanal napred.
CHV: Odaberite kanal natrag.
22. RECORD: USB disk s podacima beleženja načina DTV-a.
23. TXT: Uđite u teletext ili izađite iz njega.
Or CCD: Promenite CCD način.
24. RED: Pristupite crvenoj stavci ili stranici.
GREEN: Pristupite zelenoj stavci ili stranici.
YELLOW: Pristupite žutoj stavci ili stranici.
BLUE: Pristupite plavoj stavci ili stranici.
25. INDEX: Prikaz stranice indeksa.
MEDIA mode: ◀◀ Brzo kretanje nazad.
26. TIMESHIFT: Smena vremena načina DTV-a.
MEDIA mode: ▶▶ Brzo unapred
27. HOLD: Držite trenutnu stranicu.
MEDIA mode: ▶▶ Brzo unapred
28. REVEAL: Otkrijte skrivene informacije.
MEDIA Mode: ◀◀ Prethodno.
29. EPG: Uđite u EPG ili izađite iz njega (Elektronski vodič kroz program).
MEDIA mode: ■ Zaustavite reprodukciju i vratite se na listu datoteka.
30. SUBPAGE: Uđite u način podstranice.
MEDIA mode: ▶▶ Sledeće.
31. CANCEL(under TXT):otkažite TXT na zaslonu.
MTS/AUDIO:MTS: promenite MTS način.
or AUDIO:Odaberite TV audio način.
32. MIX(under TXT):postavljanje transparentnosti.
FAV.LIST:Lista omiljenih kanala.
33. SIZE(under TXT):Postavljanje veličina znakova.
SUBTITLE:DTV način Odaberite način titlovanja.

FOX LED TV

1.5 Instalacija baterija

(Molim vas da prevladate, ovo je samo skica.)



- 1 Zadnji poklopac daljinskog upravljača treba da bude otvoren.
- 2 Stavite dve 7# (AAA) 1.5V baterije u sistem.
Uverite se da su baterije pravilno polarizovane.
- 3 Pokrijte zadnji poklopac.

Izvadite baterije iz daljinskog upravljača ako ga neko vreme nije koristio.

Izvršite sledeće provere ako daljinski upravljač ne funkcioniše ispravno.

- Proverite da li je TV u programu.
- Proverite da li je polaritet baterija odgovarajući.
- Proverite da li baterije nisu iscrpljene.
- Uverite se da je napajanje u ispravnom stanju ili da je kabl za napajanje pravilno povezan.
- Uverite se da u blizini nema neobičnih neonskih ili fluorescentnih svetla.

2 Osnovna operacija

2.1 Uključivanje/isključivanje (opciono)

- Povežite kabl za napajanje sa **AC ulazni** . Utaknite kabl za napajanje u odgovarajuću utičnicu. - Pritisnite **Prekidač** da uključite TV, zatim pritisnite **Napajanje** dugme za uključivanje jedinice. - Pritisnite **Prekidač** ponovo da isključite TV.

Beleška: Nemojte odmah ponovo da otvarate prekidač za napajanje nakon što isključite TV; umesto toga, sačekajte jedan minut pre nego što ponovo otvorite prekidač za napajanje.

2.2 Podešavanje režima pripravnosti

- Pritisnite (⏻) dugme da biste uključili jedinicu.
- Pritisnite (⏻) dugme ponovo da vratite ekran u režim pripravnosti. Indikator napajanja svetli crveno.
- Uverite se da vaš TV nije ostavljen u režimu pripravnosti duži vremenski period.

2.3 Izbor režima unosa

Ovaj set sadrži više modova izvora signala; pritisnite dugme **Source** više puta da biste izabrali izvor signala.

FOX LED TV

3. ULAZNI IZVOR

Da biste prikazali listu izvora unosa, kliknite na dugm **SOURCE**;

Pritisnite **▲/▼** dugme da biste odabrali željeni izvor unosa;

Pritisnite dugme **ENTER** da biste uneli izvor unosa.

4. Glavni Meni

Pritisnite **MENU** dugme za prikaz GLAVNOG OSD MENI;

Pritisnite **▲/▼** da biste odabrali željeni MENI;

Pritisnite **ENTER** dugme ili **▶** dugme za ulazak u podmeni, i pritisnite **◀** dugme za povratak na prethodni meni.

Pritisnite **▲/▼** dugme da biste izabrali opcija, i zatim pritisnite dugme **ENTER** ili **▶** dugme da biste ušli u podmeni, pritisnite **◀/▶** dugme za podešavanje vrednosti ili pritisnite **◀/▶** dugme za izbor u podmeni;

Možete pritisnuti dugme **MENU** da biste sačuvali i vratili se na prethodni meni, a možete koristiti dugme **EXIT** da biste u potpunosti napustili meni.

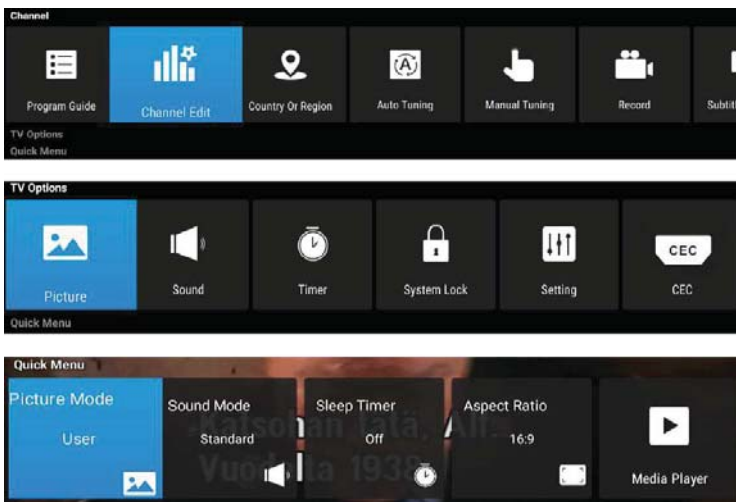

4.1 Slika MENI



4.1.1 Režim slike

Pritisnite ▲/▼ dugme da biste izabrali Režim slike, zatim pritisnite dugme **ENTER** da biste ušli i pritisnite ◀/▶ dugme da izaberete.

4.1.2 Temperatura boje

Pritisnite ▲/▼ dugme da biste izabrali **Temperatura boj**, zatim pritisnite dugme **ENTER** da biste ušli i pritisnite ◀/▶ dugme da izaberete.

4.1.3 DNR

Pritisnite ▲/▼ dugme da biste izabrali **DNR**, zatim pritisnite dugme **ENTER** da biste ušli i pritisnite ◀/▶ dugme da izaberete.

4.1.4 Proporcija širine i visine

Pritisnite ▲/▼ dugme da biste izabrali Proporcija širine i visine, zatim pritisnite dugme **ENTER** da biste ušli i pritisnite ◀/▶ dugme za podešavanje. Zatim pritisnite dugme **MENU** da se vratite direktno na prethodni meni.

4.2 Zvuk MENI

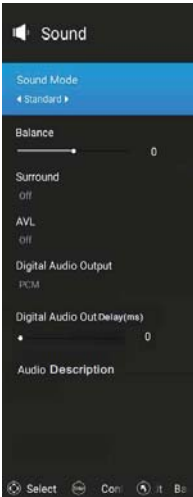

4.2.1 Režim Zvuka

Pritisnite ▲/▼ dugme da biste izabrali **Režim Zvuka**, zatim pritisnite dugme **ENTER** da biste ušli. I onda pritisnite ◀/▶ dugme da izaberete.

4.2.2 Balans

Pritisnite ▲/▼ dugme da biste izabrali **Balans**, zatim pritisnite dugme **ENTER** da biste ušli i pritisnite ◀/▶ dugme za podešavanje. Zatim pritisnite dugme **MENU** da se vratite direktno na prethodni meni.

4.2.3 Okruziti

Pritisnite ▲/▼ dugme da biste izabrali **Okruziti**, zatim pritisnite dugme **ENTER** da biste ušli i pritisnite ◀/▶ dugme za podešavanje. Zatim pritisnite dugme **MENU** da se vratite direktno na prethodni meni.

4.2.4 AVL

Pritisnite ▲/▼ dugme da biste izabrali **AVL**, zatim pritisnite dugme **ENTER** da biste ušli i pritisnite ◀/▶ dugme za podešavanje. Podešava se samo u korisničkom režimu. Zatim pritisnite dugme **MENU** da se vratite direktno na prethodni meni.

4.2.5 Digitalni audio izlaz

Pritisnite ▲/▼ dugme da biste izabrali **Digitalni audio izlaz**, zatim pritisnite dugme **ENTER** da biste ušli i pritisnite ◀/▶ dugme da izaberete.

4.2.6 Audio opis

Pritisnite ▲/▼ dugme da biste izabrali **Audio opis**, zatim pritisnite dugme **ENTER** da biste ušli.

FOX LED TV

4.3 Tajmeri MENI



4.3.1 OSD Tajmer

Pritisnite **▲/▼** dugme da biste izabrali **OSD Tajmer**, pritisnite dugme **ENTER** da biste ušli i izaberete.

4.3.2 Spavaj Tajmer

Pritisnite **▲/▼** dugme da biste izabrali **Spavaj Tajmer**, pritisnite dugme **ENTER** da biste ušli i izaberete.

4.3.3 Automatsko isključivanje

Pritisnite **▲/▼** dugme da biste izabrali Spavaj Tajmer, pritisnite dugme **ENTER** da biste ušli i izaberete.

4.4 Zaključavanje sistema



Meni (Zaključavanje sistema/Zaključavanje izvora/Zaključavanje kanala/Ograničenja programi/Promena PIN) će se prikazati kada unesete podrazumevani PIN "0000".

4.5 Meni podešavanja

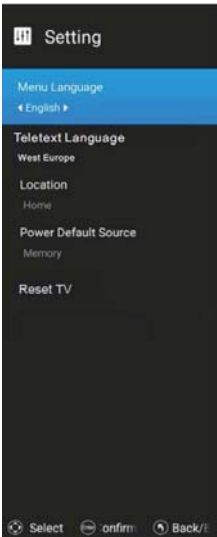

4.5.1 Jezik menija

Pritisnite ▲/▼ dugme da biste izabrali **Jezik menija**, i zatim pritisnite ◀/▶ da izaberete.

4.5.2 Jezik teleteksta

Pritisnite ▲/▼ dugme da biste izabrali **Jezik teleteksta**, i zatim pritisnite ◀/▶ da izaberete.

4.5.3 Lokacija

Pritisnite ▲/▼ dugme da biste izabrali **Lokacija**, i zatim pritisnite ◀/▶ da izaberete.

4.5.4 Podrazumevani izvor napajanja

Pritisnite ▲/▼ dugme da biste izabrali **Podrazumevani izvor napajanja**, i zatim pritisnite ◀/▶ da izaberete.

4.5.5 Resetujte TV

Pritisnite ▲/▼ dugme da biste izabrali **Resetujte TV**, i zatim pritisnite dugme **ENTER** da biste ušli.

4.6 CEC Meni



Pritisnite ▲/▼ dugme da biste izabrali Podešavanje HDMI CEC-a/Automatsko isključivanje uređaja/Automatsko uključivanje TV-a/ CEC lista uređaja/Podrška za pojačalo ARC/Preferencije zvučnika za stavka, i zatim pritisnite dugme ENTER da biste promenili.

Pritisnite dugme **EXIT** da se vratite na prethodni meni.

4.7 Kanala meni

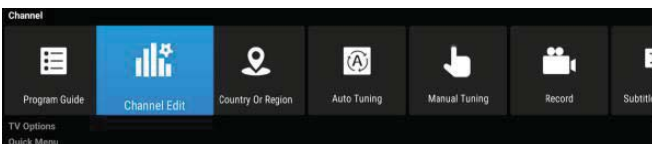

4.7.1 Programski vodič

1. Pritiskom na dugme **Programski vodič** na daljinskom upravljaču, možete aktivirati funkciju informacija o kanalu u DTV izvoru.

FOX LED TV

4.7.2 Uređivanje kanala

Pritisnite ▲/▼ dugme da biste izabrali **Uređivanje kanala**, i zatim pritisnite dugme **ENTER** da biste reprodukovali izabrani kanal.

4.7.3 Država ili oblast (Nemačka)

Pritisnite ▲/▼ dugme da biste izabrali **Država ili oblast**, i zatim pritisnite dugme **ENTER** da biste reprodukovali izabrani kanal.

4.7.4 Automatsko štimovanje

Pritisnite ▲/▼ dugme da biste izabrali **Automatsko pretraživanje**, i zatim pritisnite dugme **ENTER** da biste reprodukovali izabrani kanal.

4.7.5 Ručno štimovanje

Pritisnite ▲/▼ dugme da biste izabrali **Ručno štimovanje**, i zatim pritisnite dugme **ENTER** da biste reprodukovali izabrani kanal.

4.7.6 Snimanje Meni

Pritisnite ▲/▼ dugme da biste izabrali **Snimanje Meni**, i zatim pritisnite dugme **ENTER** da biste reprodukovali izabrani kanal.

4.7.7 Jezik podnaslova

Pritisnite ▲/▼ dugme da biste izabrali **Jezik podnaslova**, i zatim pritisnite dugme **ENTER** da biste reprodukovali izabrani kanal.

4.7.8 Multi Audio

Pritisnite ▲/▼ dugme da biste izabrali **Multi Audio**, i zatim pritisnite dugme **ENTER** da biste reprodukovali izabrani kanal.

4.7.9 DTV Podešavanja

Pritisnite ▲/▼ dugme da biste izabrali **DTV Podešavanja**, i zatim pritisnite dugme **ENTER** da biste reprodukovali izabrani kanal.

4.8 Brzi Meni

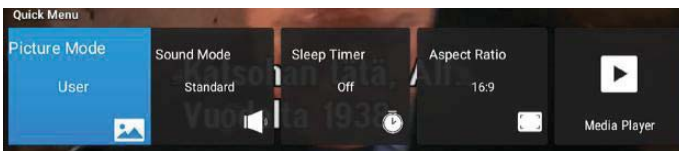

FOX LED TV

5. Početna stranica

5.1 POČETNA

Stvarna stavka je standard; slika je samo za referencu.

Da biste otišli na početnu stranicu, pritisnite dugme POČETNA.



5.2 Podešavanje

Stvarna stavka je standard; slika je samo za referencu.

Pritisnite ▲/▼ dugme da biste izabrali **Podešavanje** u **Meniju Izvor**, i zatim pritisnite dugme **ENTER** ili ► da biste ušli.

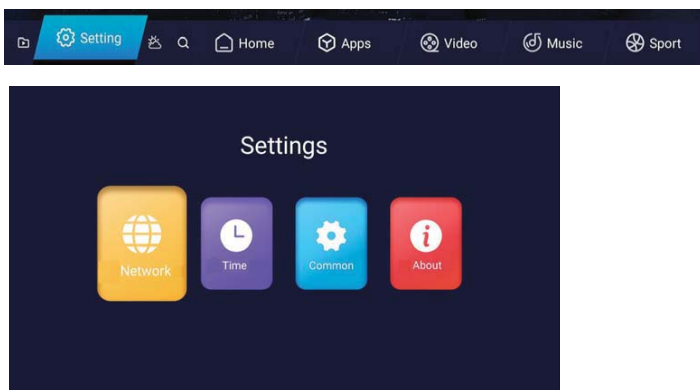

FOX LED TV

5.2.1 Mrežna Podešavanja

Pritisnite ▲/▼ dugme da biste izabrali Mrežu sa koje želite da pokrenete Vi-Fi.

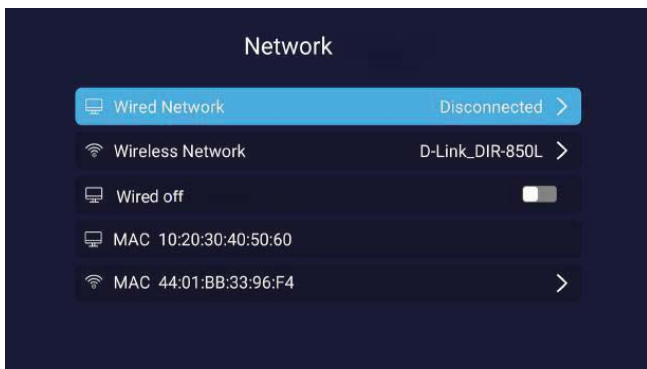

5.2.2 Vreme Podešavanja



FOX LED TV

5.2.3 Zajednički

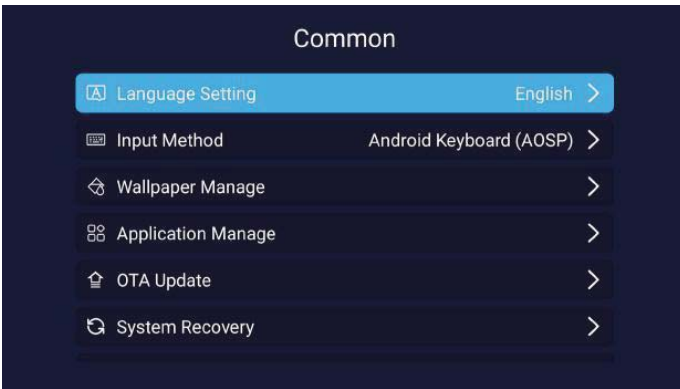

5.2.4 O TV-u

Pritisnite **◀/▶** dugme da biste izabrali O TV-u, gde možete dobiti informacije o TV-u.

5.3 Mediji

Beleška: Pre korišćenja menija **MEDIJI**, nakon umetanja USB uređaja ili memorijske kartice, izaberite mediji kao izvor pritiskom na dugme **SOURCE**.

Pritisnite **▲/▼** dugme da biste izabrali **Mediji** u **Meniju Izvor**, i zatim pritisnite dugme **ENTER** ili **▶** da biste ušli. Pritisnite dugme **MEDIA** na daljinskom upravljaču, takođe možete pristupiti medijima.

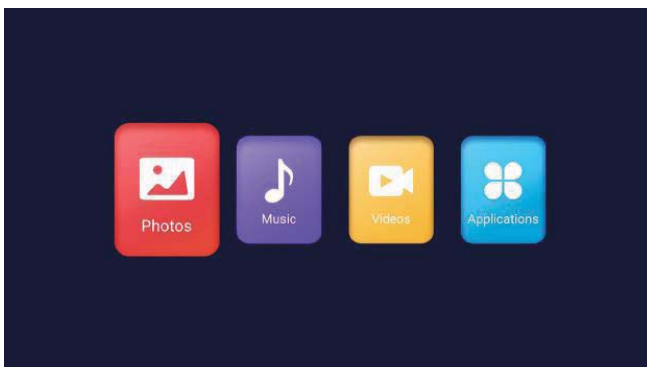

FOX LED TV

5.3.1 FOTO

Pritisnite ◀▶ dugme da biste izabrali **Fotografije** u glavnom meniju, i zatim pritisnite dugme **ENTER** da biste ušli.

Pritisnite dugme **EXIT** da se vratite na prethodni meni.



Nakon što pritisnete dugme **INFO**, možete videti informacije o fotografiji koja se trenutno reprodukuje, i zatim pritisnuti ▶|| dugme kiz za reprodukciju ili pauziranje, možete videti stanje reprodukcije sa desne strane.

Zatim pritisnite ▲/▼ ili ◀▶ dugme da biste ocenili sliku.

5.3.2 Muzika



5.3.3 Video

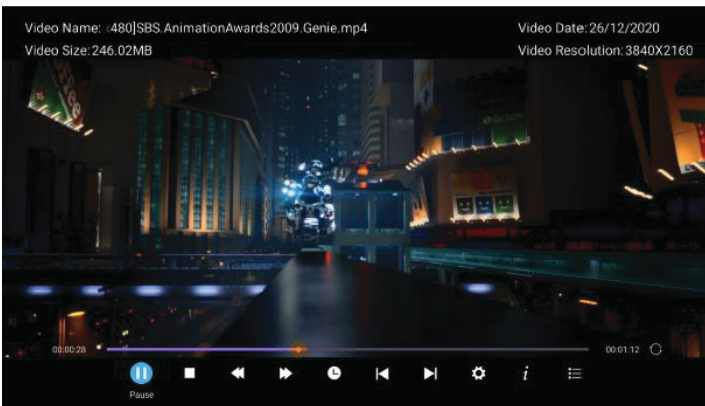

5.3.4 Aplikacije

Pritisnite ◀▶ dugme da biste izabrali **Aplikacije** u glavnom meniju, zatim pritisnite dugme **ENTER** da biste ušli.

Pritisnite dugme **EXIT** da se vratite na prethodni meni.

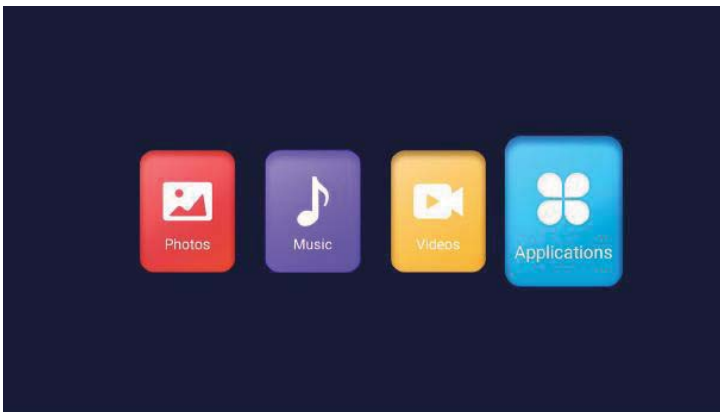

6 Hotelski način rada

Pritisnite dugme **MENI** i pritisnite „4588” u postavke Hotela.

FOX LED TV

7 . Tehnička specifikacija

Model proizvoda	32AOS430E	
Veličina ekrana	32" dijagonala	
Proporcija širine i visine	16:9	
Napajanje	AC 100-240V~,50/60Hz	
Potrošnja struje	60W	
TV sistem	PAL B/G D/K I,SECAM B/G D/K DVB-T/T2/C/S/S2 (opcija s/s2) (DVB-C signal je odsutan u nekim zemljama ili regionima.)	
Audio izlazna snaga (interna)	8Wx2	
Ulazni terminal	Antenski ulaz	x 2(S2 opcija)
	USB ulazni	x 2
	HDMI ulazni	x 3
	VGA ulazni	NE
	PC AUDIO ulazni	NE
	Audio ulazni (L/R)	x 1
	Video ulazni	x 1
	YPbPr ulazni	NE
	RJ45 ulazni	x 1
	Ulazni CI kartice	x 1
	SCART ulazni/izlazni	NE
	DC ulazni (12V)	NE
	KARTICE	NE
Izlazni terminal	Slušalica	x 1
	Audio linijski izlazni (L/R)	NE
	Video izlazni	NE
	Optički	NE
	Koaksijalni izlazni	x 1
Radna temperatura	0°C-40°C	
Radna vlažnost	20% ~ 80% Bez kondenzacije	

Beleška: Gore navedene karakteristike su podložne promeni bez upozorenja u cilju poboljšanja kvaliteta.

8. Podržani režimi signala

A. HDMI režim

<u>Rezolucija</u>	Horizontalna frekvencija (Khz)	<u>Vertikalna frekvencija (Hz)</u>
480p	31.468	59.94
576p	31.25	50.00
720P	45.00	60.00
1080i	33.75	60.00
1080P(1920x1080)	67. 50	60.00

- *Poruka upozorenja će se pojaviti na ekranu ako je signal koji ekran prima izvan dozvoljenog opsega.*

-Na ekranu možete proveriti format ulaznog signala.

9. Jednostavno otklanjanje poteškoća

Ako ekran pokvari ili se njegove performanse drastično promene, proverite ekran u skladu sa smernicama u nastavku. Ne zaboravite da pregledate periferne uređaje kako biste identifikovali koren problema.

Simptom	Rešenje
Napajanje se ne može aktivirati. (Indikator napajanja ne svetli.)	-Potvrdite da su oba kraja kabla za napajanje pravilno umetnuta u utičnicu i da li je zidna utičnica funkcionalna.
Prikazuje se poruka Nema ulaznog signala.	- Proverite da li je signalna linija ispravno povezana. -Potvrdite da su relevantni periferni uređaji uključeni. -Uverite se da izabrani izbor ulaza odgovara ulaznom signalu.
Daljinski upravljač ne radi ispravno.	-Proverite da baterije nisu istrošene. (Koristite novu bateriju.) -Potvrdite da daljinski upravljač radi u svom dometu. - Uverite se da je daljinski upravljač usmeren ka prozoru daljinskog upravljača ekrana. - Uverite se da nema prepreka između daljinskog upravljača i njegovog prozora.
Na ekranu se nalaze trepćuće tačke ili pruge.	- Uverite se da nema emisija (auto, VN žice ili neonske sijalice) ili drugih potencijalnih izvora smetnji.
Boja ili kvalitet slike se pogoršavaju.	- Proverite da li su sva video podešavanja, kao što su osvetljenost, kontrast i boja, pravilno podešena. -Za dodatne informacije o video postavkama, pogledajte OSD funkcije poglavlja 2.
Položaj i veličina ekrana su netačni.	-Potvrdite da su pozicija i veličina ekrana na odgovarajući način.
Slika ili boja su netačne.	- Proverite da li je signalna linija ispravno povezana. -Kada ste povezani sa računarom, možete da promenite rezoluciju računara da biste dobili odgovarajuću sliku. Disparitet u izlaznom signalu računara može uticati na prikaz slike.
Prikažite poruku upozorenja.	- Proverite da li je ulazna linija signala na odgovarajući način obezbeđena. -Izaberite odgovarajući ulazni signal. -Pogledajte Podržani režimi signala u poglavlju 4 za dodatne



USER MANUAL

LED Television Model: 32AOS430E

Thank you for purchasing this device.

FOX LED televisions are known for their great performance, as for modern, functional and elegant design. Besides that, we constantly improve our customer support, we have highly efficient and wide network of services, that make our proud customers feel safe.

You made a right choice.

Now it's time for instructions, they are not complicated, but you have to follow them.

EN

IMPORTANT SAFETY INSTRUCTIONS

WARNING

- TO PREVENT FIRE OR SHOCK HAZARD, DO NOT USE AN EXTENSION CORD, RECEPTACLE OR OTHER OUTLET UNLESS THE BLADES CAN BE TO PREVENT BLADE EXPOSURE.
- TO PREVENT FIRE OR SHOCK HAZARD, DO NOT EXPOSE THIS APPLIANCE TO RAIN OR MOISTURE.



This lightning flash with arrowhead symbol in an equilateral triangle alerts users to the presence of uninsulated dangerous voltage within the products enclosure that may be of sufficient magnitude to constitute a risk of electric shock.

CAUTION

**RISK OF ELECTRIC SHOCK
DO NOT OPEN**

Warning: To reduce the risk of electric shock, do not remove cover (or back). No user serviceable parts inside. Refer servicing to qualified service personnel.



The exclamation mark within an equilateral triangle alerts users to the presence of important operating and maintenance (servicing) instructions in the literature accompanying the appliance.

This appliance should not be exposed to water and no object filled with liquid such as a vase should be placed on the unit.

CAUTION

- Danger of explosion if batteries are incorrectly replaced.
- Replace with only equivalent type of battery.
- Do not expose battery to direct sunlight or any other source of heat.
- Ensure proper disposal of used batteries.
- Where the MAINS plug or an appliance coupler is used as the disconnect device, the disconnect device shall remain readily operable.
- To reduce the risk of electric shock, do not perform any servicing other than what is mentioned in the operating manual.
- There are no user-serviceable parts inside the TV; do not open the TV casing.

IMPORTANT INFORMATION

If a television is not positioned in a sufficiently stable location, it can be potentially hazardous due to falling. Many injuries, particularly to children, can be avoided by taking simple precautions such as:

- Using cabinets or stands recommended by the manufacturer of the television.
- Only using furniture that can safely support the television.
- Ensuring the television is not overhanging the edge of the supporting furniture.
- Not placing the television on tall furniture (for example, cupboards or bookcases) without anchoring both the furniture and the television to a suitable support.
- Not standing the televisions on cloth or other materials placed between the television and supporting furniture.
- Educating children about the dangers of climbing on furniture to reach the television or its controls.



Safe installation

Use the belt fixing the television to facilitate restraining the television from toping forward.



1. **Read Instructions** - All the safety and operating instructions should be read before the appliance is operated.
2. **Retain Instructions** - The safety and operating instructions should be retained for future reference.
3. **Heed Warnings** - All warnings on the appliance and in the operating instructions should be adhered to.
4. **Follow Instructions** - All operating instructions should be followed.



5. **Water and Moisture** - The appliance should not be used near water.
6. **Cart and Stands** - The appliance should only be used with a cart or stand that is recommended by the manufacturer.
7. **Wall or Ceiling Mounting** - The appliance should be mounted to a wall or ceiling only as recommended by the manufacturer.
8. **Ventilation** - The appliance should be well situated so that its location or position does not interfere with its proper ventilation.
9. **Heat** - This appliance should be placed away from heat sources such as radiators, heat registers and stoves.
10. **Power Sources** - The appliance should only be connected to a power supply as described in the operating instructions or as marked on the appliance.
11. **Grounding or Polarization** - Precautions should be taken.
12. **Power Cord Protection** - Power supply cord should be routed so that it is not likely to be walked on, pinched by items placed upon it against the cord and its end.
13. **Cleaning** - The appliance should be cleaned only as recommended by the manufacturer.
14. **Power Line** - An outdoor antenna should be located away from power lines.
15. **Outdoor Antenna Grounding** - If an outside antenna is connected to the receiver, the antenna system must be grounded so as to provide against voltages and built-up static charges.
16. **Non-use Periods** - The power cord of the appliance should be unplugged from the outlet when left unused for a long period of time.
17. **Object and Liquid Entry** - Care should be taken so that objects did not fall, and liquids are not spilled into the enclosure through openings.
18. **Conditions requiring Service** - The appliance should be serviced by qualified service personnel when:
 - The power-supply cord or the plug has been damaged.
 - Objects have fallen on or liquid has been spilled into the appliance.
 - The appliance has been exposed to rain.
 - The appliance does not appear to operate normally or exhibits a marked change in performance.
19. The ventilation should not be impeded by covering the ventilation opening with items, such as newspapers, table-cloths, curtains, etc.
 No naked flame sources, such as lighted candles, should be placed on the apparatus.
 The apparatus shall be connected to mains socket outlet with a protective earthing connection.
 The appliance coupler regard as disconnection device, the disconnect device shall remain readily operable.

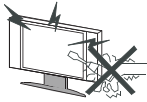

Warning

High voltages are used in the operating of this product. Do not remove the back cover of the cabinet. Refer servicing to qualified service personnel.

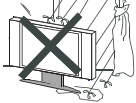

Warning

To prevent fire or electrical shock hazard, do not expose the main unit to rain or moisture.



Warning

Do not drop or push objects into television cabinet slots or openings. Never spill any kind of liquid on the television receiver.

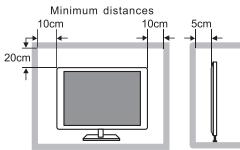

Caution

If the television is to be built into a compartment or similarly enclosed, the minimum distances must be maintained.

Heat built up can reduce the service life of your television, and can also be dangerous.



Caution

Never stand on, lean on, push suddenly the product or its stand.

You should pay special attention to children.

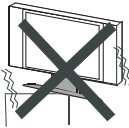

Caution

Do not place the main unit on an unstable cart stand, shelf or table.

Serious injury to an individual, and damage to the television, may result should it fall.



Caution

When the product is not used for an extended period of time, it is advisable to disconnect the AC power cord from the AC outlet.

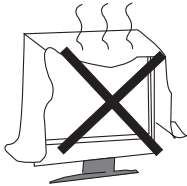

Caution

Avoid exposing the main unit to direct sunlight and other sources of heat. Do not position television receiver directly on other products which give off heat. E.g. Video cassette players, audio amplifiers. Do not block the ventilation holes in the back cover. Ventilation is essential to prevent electrical failure. Do not squash power supply cord under the main unit.



Caution

The panel used in this product is made of glass. It can break when the product is dropped or applied with force. Individuals should execute caution when dealing with broken glass should the panel break.



- Place the TV on a firm and flat surface, leaving a space of at least 10cm around the set and 30cm from the top of the set to the wall or cabinet. Ensure the TV is positioned close to the wall to avoid it falling when pushed.

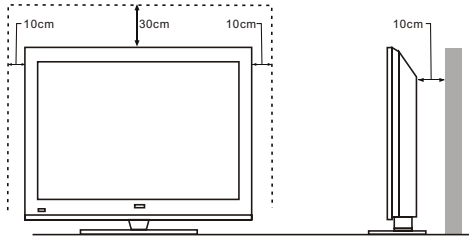

- When you turning the TV set, do not hold the top side of the TV set, you should hold the bottom side.

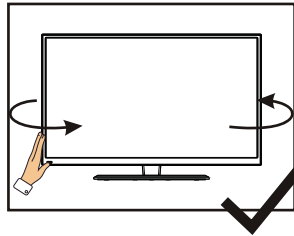
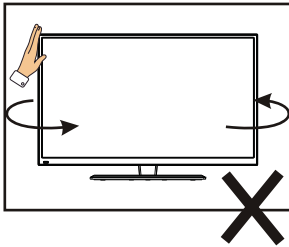

- When you lifting the TV set, do not use one hand to handle it, you should lift the TV set by two hands.

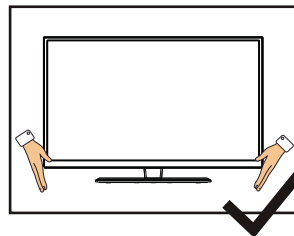
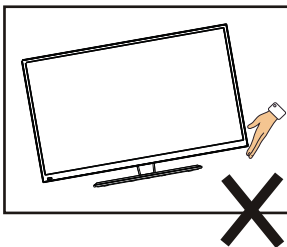

CONTENTS

1. Connection and Preparation of TV.....	2
1.1 Accessories	2
1.2 Installation of Stand.....	2
1.3 Keys and Interfaces.....	3
1.4 Remote Control.....	4
1.5 Installation of Batteries.....	5
2. Basic Operation.....	5
2.1 Power ON/OFF(Optional).....	5
2.2 Setting of Standby Mode.....	5
3. Input Source.....	6
4. Main menu	6
5. Home Page	13
5.1 HOME	13
5.2 Settings.....	13
5.3 Media	15
6. Hotel Mode.....	17
7. Technical Specification.....	18
8. Supported Signal Modes.....	19
9. Simple Troubleshooting	20

1.Connection and Preparation of TV

1.1 Accessories

- * User Manual
- * Remote Control
- * Battery(UM-4/R03P/AAA)
- * Wall Mount Kit (Pre-assembled)(Optional)

1.2 Installation of Stand

(For the physical structure, please refer to the real object)

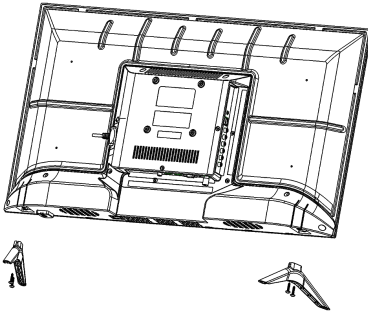

- ① Place the TV with the front panel facing downwards on the soft cloth or soft pads on a desk.
- ② Insert the stand into the bottom socket of the TV.
- ③ Insert the screws into the sockets and tighten them.

1.3 Keys and Interfaces

The design and specification takes actual products as the standard

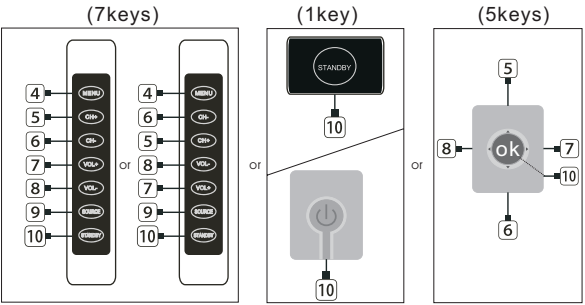
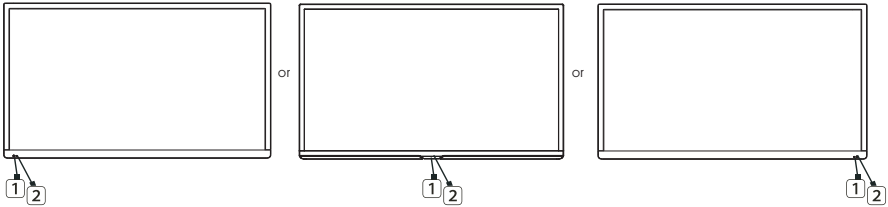

1. REMOTE SENSOR WINDOW
2. POWER INDICATOR
3. SPEAKER
4. MENU KEY
5. PROGRAM “+” KEY
6. PROGRAM “-” KEY
7. VOLUME “+” KEY
8. VOLUME “-” KEY
9. SOURCE KEY
10. STANDBY KEY
11. POWERPLUG INPUT

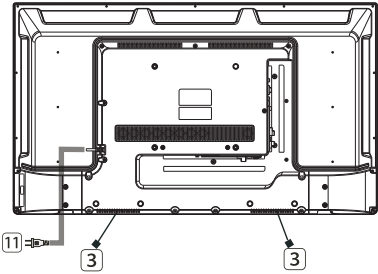

HDMI2 (ARC)	HDMI3	USB1 5V==500mA	USB2 5V==500mA	CI			
VIDEO	AV IN L R	RF IN (T2)	RF IN (S2) 13V/18V==500mA	EARPHONE	RJ45	COAXIAL	HDMI1

1.4 Remote Control

(Here is only the sketch, please in kind prevail)

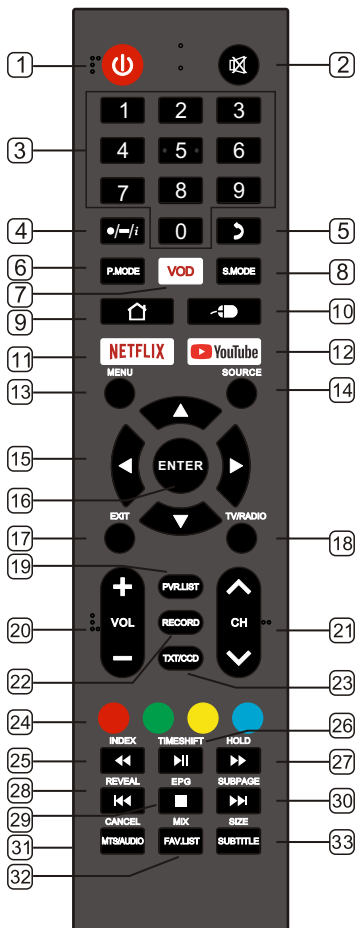

1. STANDBY(⏻) : Standby turn on and off.
2. MUTE: Mute sound.
3. 0-9 : Continue to press the keys to select a channel.
4. ●/~/i
 - :Press this button to enter a program number with different digits.eg.10.1,10.2.
 - ~/:Dot button and minor channel number.
 - i :Display the information of current video and audio.
5. RECALL:Return to previous channel.
6. P.MODE:Select the picture mode.
- 7.VOD: Open the VOD APP with shortcut key.
(Note: If the VOD APP is not pre-installed, this shortcut key is invalid)
8. S.MODE:Select the sound mode.
9. HOME:Enter to homepage.
10. MOUSE:Turn on the remote control mouse or turn it off.
11. NETFLIX:Enter Netflix APP.
12. YouTube:Enter YouTube APP.
13. MENU:Enter or exit menu.
14. SOURCE:Select the signal source.
15. ▲▼,◀▶ Key:The menu item selection.
16. ENTER: Confirm or enter.
17. EXIT:Exit menu or operation.
18. TV/RADIO:Select the TV or Radio mode.
19. PVR.LIST: PVR list.
20. VOL+: Increase the volume.
VOL-: Decrease the volume.
21. CH▲ : Select the channel forward.
CH▼ : Select the channel backward.
22. RECORD:DTV mode record data USB disk.
23. TXT: Enter or exit teletext.
orCCD:Change the CCD mode.
24. RED: Access the red item or page.
GREEN: Access the green item or page.
YELLOW:Access the yellow item or page.
BLUE: Access the blue item or page.
25. INDEX:Display the index page.
MEDIA mode: ◀◀ Fast Backward.
26. TIMESHIFT:DTV mode time shift.
MEDIA mode: ▶▶ Press one time to pause, press again to playback.
27. HOLD:Hold the current page.
MEDIA mode: ▶▶ Fast Forward.
28. REVEAL:Reveal the hidden information.
MEDIA Mode: ◀◀ Previous.
29. EPG:Enter or exit EPG(Electronic Program .Guide).
MEDIA mode: ■ Stop the playback and return to file list.
30. SUBPAGE:Enter the sub page mode.
MEDIA mode: ▶▶ Next.
31. CANCEL(under TXT):cancel the TXT on screen.
MTS/AUDIO:MTS:Change the MTS mode.
or AUDIO:Select TV audio mode.
32. MIX(under TXT):setting transparency.
FAV.LIST:Favorite channel list.
33. SIZE(under TXT):setting sizes of the charcater.
SUBTITLE:DTV mode select subtitle mode.

1.5 Installation of Batteries

(Here is only the sketch, please in kind prevail)

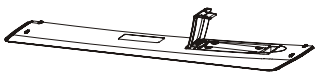

- ① Open the back lid of the remote control.
- ② Install two 7#(AAA)1.5V batteries.
Ensure the correct polarity of the batteries.
- ③ Cover the back lid.
Please take out of the batteries from the remote control for long time of no use.

If the remote control doesn't work properly, please carry out the following checks.

- Check the TV is turned on.
- Check the polarity of the batteries are correct.
- Check the batteries are not drained.
- Check the power supply is normal or the power cord is correctly connected.
- Check there are no special fluorescent light or neon light around.



2. Basic Operation

2.1 Power ON/OFF(Optional)

- Connect the power cord to the **AC input**. Insert the power cord into the appropriate socket.
- Press the **Power switch** to switch on the TV, then press **Power** button to turn on the unit.
- Press the **Power switch** again to switch off the TV.

Note: After switch off the TV, please don't immediately re-open the power switch ,should be delayed one minute more to re-open the power switch.

2.2 Setting of Standby Mode

- Press () button to turn on the unit.
- Press () button again to return the display to standby mode. The power indicator turns red.
- Be sure not to set your TV in standby mode for a long period of time.

3. INPUT SOURCE

Press **SOURCE** button to display the input source list;

Press **▲/▼** button to select the input source you want to watch;

Press **ENTER** button to enter the input source;

4. Main Menu

Press **MENU** button to display the MAIN OSD MENU;

Press **▲/▼** button to select the MENU you want;

Press **ENTER** button or **▶** button to enter the sub menu, and press **◀** button to return back to the previous menu.

Press **▲/▼** button to select the option and then press **ENTER** button or **▶** button to enter the submenu, press **◀/▶** button to adjust the value or press **◀/▶** button to select in the sub menu;

You can press **MENU** button to save and return back to the previous menu, and press **EXIT** button to exit the entire menu.

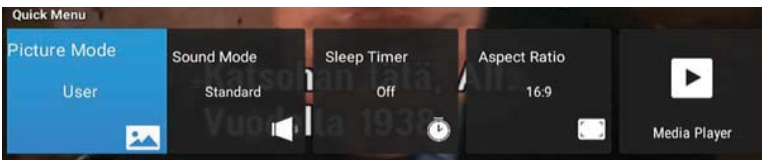
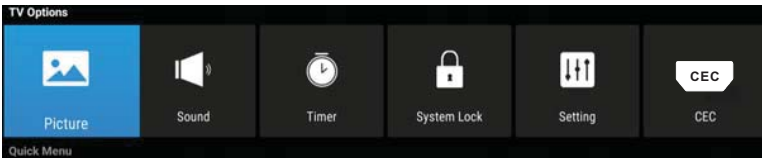
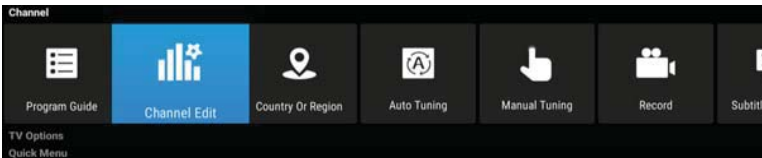

4.1 Picture Menu



4.1.1 Picture Mode

Press ▲/▼ button to select Picture Mode, then press **ENTER** button to enter and press ◀/▶ button to select.

4.1.2 Colour Temperature

Press ▲/▼ button to select **Colour Temperature**, then press **ENTER** button to enter and ◀/▶ button to select.

4.1.3 DNR

Press ▲/▼ button to select **DNR**, and then press **ENTER** button to enter and ◀/▶ button to select.

4.1.4 Aspect Ratio

Press ▲/▼ button to select Aspect Ratio, then press **ENTER** button to enter and press ◀/▶ button to adjust. Then press **MENU** button to return back the previous menu directly.

4.2 Sound Menu

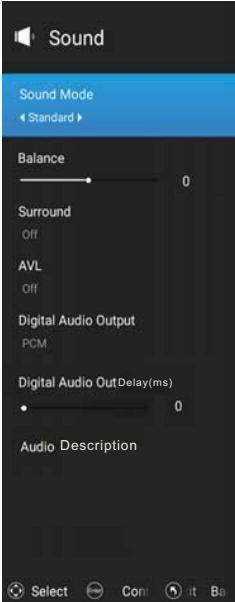

4.2.1 Sound mode

Press ▲/▼ button to select **Sound mode**, and then press **ENTER** button to enter. And then press ◀/▶ button to select.

4.2.2 Balance

Press ▲/▼ button to select **Balance**, then press **ENTER** button to enter and press ◀/▶ button to adjust. Then press **MENU** button to return back the previous menu directly.

4.2.3 Surround

Press ▲/▼ button to select **surround**, then press **ENTER** button to enter and press ◀/▶ button to adjust. Then press **MENU** button to return back the previous menu directly.

4.2.4 AVL

Press ▲/▼ button to select **AVL**, then press **ENTER** button to enter and press ◀/▶ button to adjust. It can only be adjusted under user mode Then press **MENU** button to return back the previous menu directly.

4.2.5 Digital Audio output

Press ▲/▼ button to select **Digital Audio Output**, then press **ENTER** button to enter and press ◀/▶ button to select.

4.2.6 Audio Description

Press ▲/▼ button to select **Audio Description**, then press **ENTER** button to enter.

4.3 Timer Menu

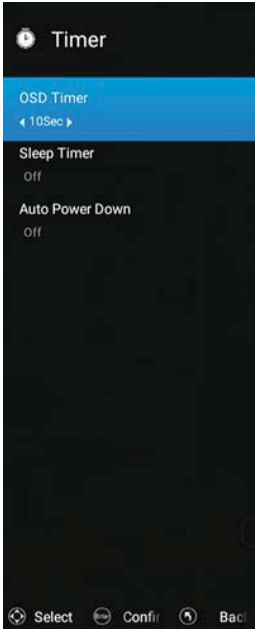

4.3.1 OSD Timer

Press ▲/▼ button to select OSD Timer , Press ENTER button to enter and select.

4.3.2 Sleep Timer

Press ▲/▼ button to select Sleep Timer, Press ENTER button to enter and select.

4.3.3 Auto Power Down

Press ▲/▼ button to select Sleep Timer, Press ENTER button to enter and select.

4.4 System lock



Enter the default PIN "0000",will enter the **menu(System Lock/Source Lock/Channel Lock/Program Restrictions/Change PIN).**

4.5 Setting Menu



4.5.1 Menu Language

Press ▲/▼ button to select **Menu Language**, and then press ◀/▶ to select.

4.5.2 Teletext Language

Press ▲/▼ button to select **Teletext Language**, and then press ◀/▶ to select.

4.5.3 Location

Press ▲/▼ button to select **Location**, and then press ◀/▶ to select.

4.5.4 Power Default Source

Press ▲/▼ button to select **Power Default Source**, and then press ◀/▶ to select .

4.5.5 Reset TV

Press ▲/▼ button to select **Reset TV**, and then press **ENTER** button to enter .

4.6 CEC Menu

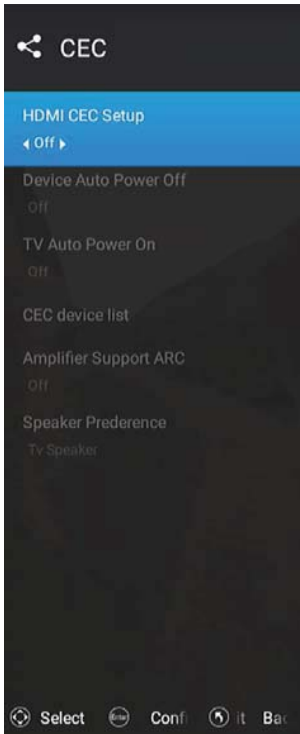

Press ▲/▼ button to select HDMI CEC Setup/Device Auto Power Off/TV Auto Power on/CEC device list/Amplifier Support ARC/Speaker Preference item and then press ENTER ENTER button to change.

Press **EXIT** button to return the previous menu.

4.7 Channel Menu

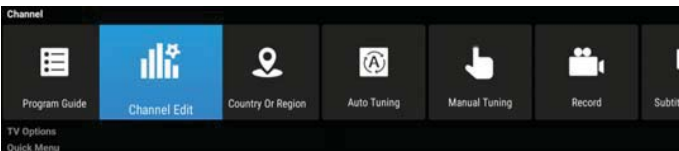

4.7.1 Program Guide

1. In the DTV source, you can start channel information function by pressing **Program Guide** button on the remote control..

4.7.2 channel Edit

Press ▲/▼ button to select **channel Edit**, and then press **ENTER** button to play the channel selected.

4.7.3 Country or Region(Germany)

Press ▲/▼ button to select **Country and Region**, and then press **ENTER** button to play the channel selected.

4.7.4 Auto Tuning

Press ▲/▼ button to select **Auto Search**, and then press **ENTER** button to play the channel selected.

4.7.5 Manual Tuning

Press ▲/▼ button to select **Manual Tuning**, and then press **ENTER** button to play the channel selected.

4.7.6 Record menu

Press ▲/▼ button to select **Record menu**, and then press **ENTER** button to play the channel selected.

4.7.7 Subtitle Language

Press ▲/▼ button to select **Subtitle Language**, and then press **ENTER** button to play the channel selected.

4.7.8 Multi Audio

Press ▲/▼ button to select **Multi Audio**, and then press **ENTER** button to play the channel selected.

4.7.9 DTV Setting

Press ▲/▼ button to select **DTV Setting**, and then press **ENTER** button to play the channel selected.

4.8 Quick Menu

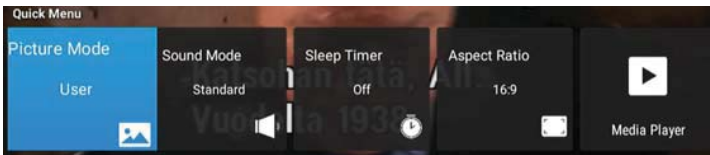

5. Home Page

5.1 HOME

The picture is for a reference only; the actual item is the standard.

Press HOME button to enter home page.



5.2 Setting

The picture is for a reference only; the actual item is the standard.

Press ▲/▼ button to select **Setting** in the **Source Menu**, and then press **ENTER** or ► to enter.

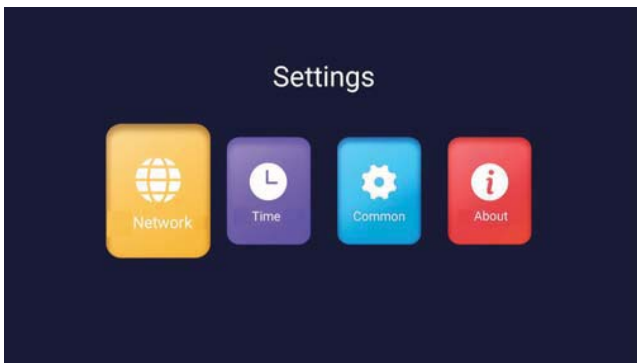
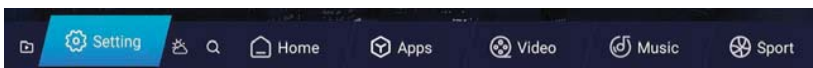

5.2.1 Network Setting

Press ▲/▼ button to select the Network that you can open the Wi-Fi.

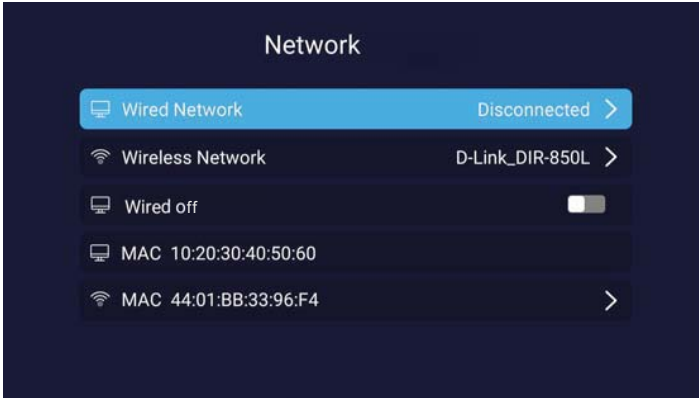

5.2.2 Time Setting

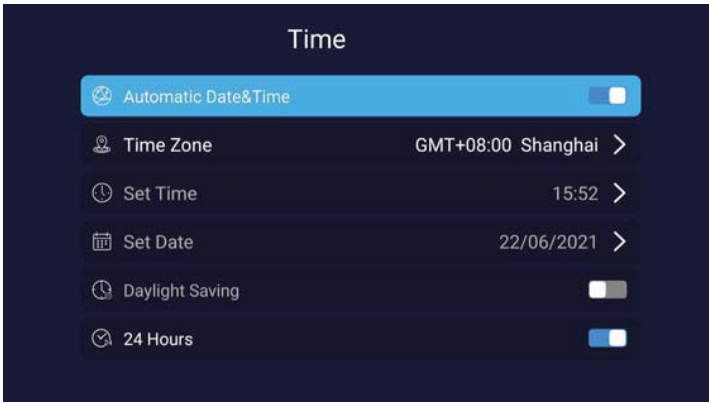

5.2.3 Common

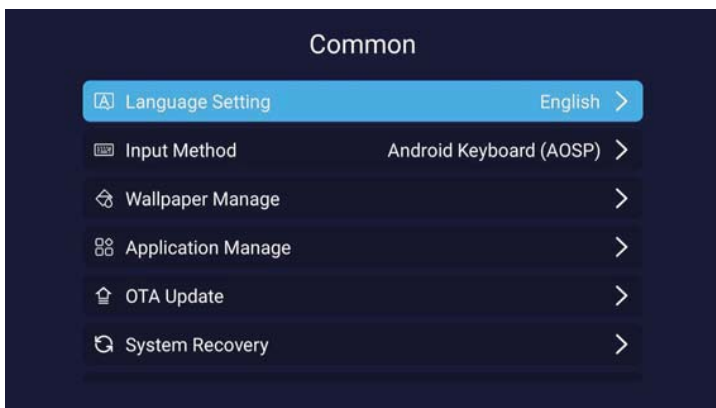

5.2.4 About TV

Press ◀/▶ button to select the About TV that you can find the information about TV.

5.3 Media

Note: Before operation **MEDIA** menu, Plug in USB device or memory card, then press **SOURCE** button to set the Source to Media.

Press ▲/▼ button to select **MEDIA** in the **Source Menu**, and then press **ENTER** or ▶ to enter. You can also enter the Media by pressing **MEDIA** button on the remote control.

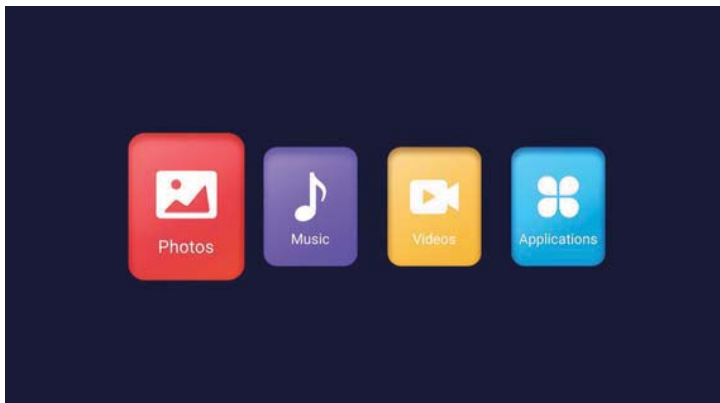

5.3.1 Photo

Press ◀/▶ button to select **Photos** in the main menu, and then press **ENTER** button to enter. Press **EXIT** button to return back to the previous menu.



You can see the information of the current playing photo after press **INFO** button, then press ▶|| button to play or pause, you can see the playing state in the right. Then press ▲/▼ or ◀/▶ button to rotate the picture.

5.3.2 Music

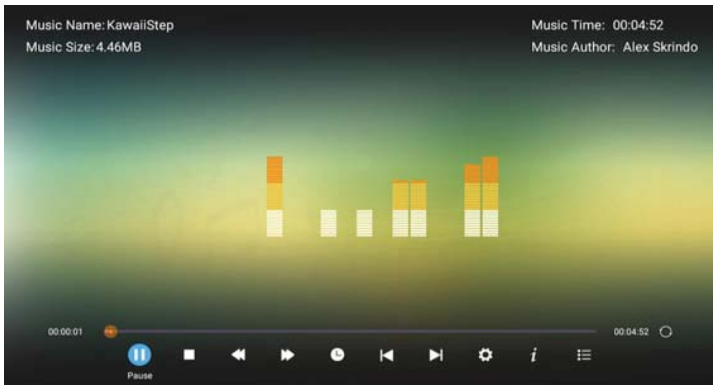

5.3.3 Video

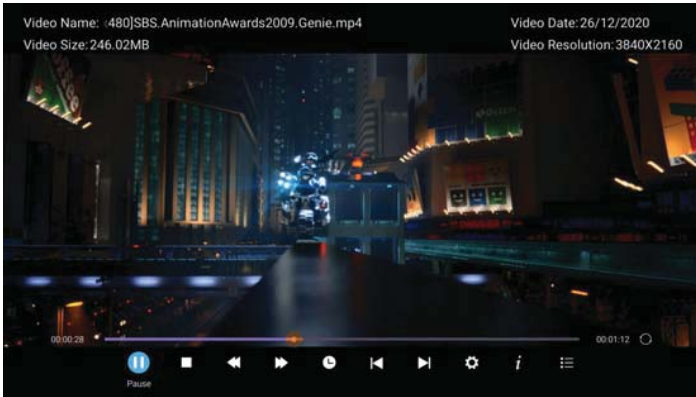

5.3.4 Applications

Press ◀▶ button to select **Applicatitons** in the main menu, then press **ENTER** button to enter.
Press **EXIT** button to return back to the previous menu.

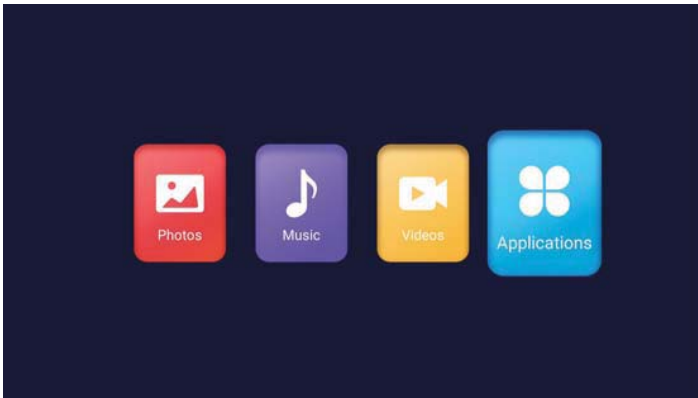

6 Hotel Mode

Press the **MENU** button, and then press "source4588 " to the Hotel Setting.

7. Technical Specification

Product Model	32AOS430E	
Screen Size	32" diagonal	
Aspect Ratio	16:9	
Power Supply	AC 100-240V~,50/60Hz	
Power Consumption	60W	
TV System	PAL B/GD/K I,SECAM B/G D/K DVB-T/T2/C/S/S2(s/s2 option) (There is no DVB-C signal in some Countries or Areas.)	
Audio Output Power (Internal)	8Wx2	
Input Terminal	Antenna Input	x 2 (S2 option)
	USB Input	x 2
	HDMI Input	x 3
	VGA Input	NO
	PC AUDIO Input	NO
	Audio Input (L/R)	x 1
	Video Input	x 1
	YPbPr Input	NO
	RJ45 Input	x 1
	CI card In	x 1
	SCART In/Output	NO
	DC In (12V)	NO
	CARD SLOT	NO
Output Terminal	Earphone	x 1
	Audio Line Out(L/R)	NO
	Video Output	NO
	Optical	NO
	Coaxial out	x 1
Working Temperature	0°C~40°C	
Working Humidity	20% ~ 80% Non-condensing	

Note: the specification shown above may change without notice for quality improvement.

8. Supported Signal Modes

A.HDMI Mode

Resolution	Horizontal Frequency (Khz)	Vertical Frequency (Hz)
480p	31.468	59.94
576p	31.25	50.00
720p	45.00	60.00
1080i	33.75	60.00
1080p(1920x1080)	67.50	60.00

-When the signal received by the Display exceeds the allowed range, a warning message will appear on the screen.

-You can confirm the input signal format onscreen.

9. Simple Troubleshooting

If the display fails or the performance changes dramatically, check the display in accordance with the following instructions. Remember to check the peripherals to pinpoint the source of the failure.

Symptom	Solution
Power cannot be turned on.(Power indicator does not light.)	-Check that both ends of the power cable are plugged into the socket appropriately and the wall socket is operational
No Input Signal message appears.	-Check that the signal line is connected properly. -Check that the power of the relevant peripherals is turned on. -Check that the Input option that has been selected matches with the input signal.
The remote control does not function properly.	-Check the batteries are not drained.(Use new batteries.) -Check that the remote control is within the operating range. -Check that the remote control is pointed to the remote control window on the display. -Check that there are no obstacles between the remote control and the remote control window.
Flashing spots or stripes appear on the screen.	-Check that there are no emission (Car, HV cable or Neon lamp) or other possible interference sources.
Image colour or quality deteriorates.	-Check that all the video settings are adjusted appropriately, such as brightness, contrast, colour etc. -For more information about video settings, refer to OSD Functions in Chapter 2.
Screen position and size are incorrect.	-Check that the screen position and size is adjusted appropriately.
Image or colour is incorrect.	-Check that the signal line is connected properly. -When connecting to a PC, you can change the resolution of the PC to acquire the correct image. The discrepancy of the PC output signal may affect the display of the image.
Display warning message.	-Check that the input signal line is properly fixed. -Select the correct input signal. -For more information, refer to Supported Signal Modes in Chapter 4.



Nadamo se da ste pažljivo pročitali uputstva i da ćete ih se pridržavati. Za više informacija o FOX uređajima posetite našu internet stranicu:

www.foxelectronics.rs